

Fall 2008
ISSUE 2
\$3.95

Uniform & Accessories Warehouse

MANUFACTURER & WHOLESALE OF LAW ENFORCEMENT UNIFORMS & ACCESSORIES

BADGES JACKETS DUTY GEAR FOOT WEAR FLASHLIGHTS
BODY ARMOR HEAD WEAR OUTERWEAR LIGHTBARS UNIFORMS
SHIRTS EMBLEMS AND MUCH MORE...



Warning lights see pages 92-115



Shirts see pages 13-22



Jackets see pages 23-32



Dress clothes see pages 33-39



Badges see pages 63-73



Emblems/Name tags/Insignia see pages 74-86



Duty gear see pages 49-59

1-818-341-1500 ♦ 1-877-643-1100
WWW.UNIFORMS4ALL.COM (within US Only)

How Can We Help YOU?

**We want you to be completely satisfied with your purchases from us!
Please feel free to contact our friendly customer service representatives for any assistance.**

WE OFFER

- HIGH QUALITY PRODUCTS • FACTORY DIRECT LOW PRICING • FAST SHIPPING
- KNOWLEDGEABLE CUSTOMER SERVICE • HARD TO FIND ITEMS • 24 HOUR A DAY INTERNET ORDERING

CONVENIENT PAYMENT OPTIONS

We accept most credit cards! You may also make purchases by money order and cashier's checks. Now you can also email us your orders. We also accept purchase orders upon credit approval.

Past due accounts will be subjected to a finance charge per month and possibly a re-invoicing fee. All invoices over 60 days will be sent out to collections and are subject to a collections fee.



CLAIMS

We take great care to prepare your order for shipment. The majority of the orders that we ship arrive in excellent condition. Upon receipt of your purchase, please inspect the package and check the packing invoice to ensure you received your entire order.

If your package is received damaged, please refuse the package and immediately contact our customer service department. All claims must be reported within 24 hours of receipt.

SHIPPING METHOD

Because we know your time is valuable, we attempt to ship all orders the same day. Customized and tailored items ship upon completion. Several shipping options are available. Please contact a customer service representative with any shipping inquiries.

RETURNS

If within 30 days of receipt you are not satisfied with your purchase you may exchange or return non-tailored & non-custom items in the original condition. Custom items such as lightbars, special orders, custom badges or patches, uniforms with tailoring or alterations, may be returned for adjustment if we have not made them in accordance with your supplied written instructions. Under these conditions, only defective merchandise may be returned.

You may make any change to an order before we ship it to you! However, after an order has been processed, a cancellation & restocking fee will be billed to you due to your cancellation.

Please contact our customer service department to request a return or exchange. **Your original invoice is required for any return.**

MISCELLANEOUS

We strive to maintain accuracy in our catalogs and are not responsible for misprints due to human error or mistakes by the editor. All prices are subject to change without notice.

LAW ENFORCEMENT SALES POLICY

It is the customer's responsibility to verify that the purchase and use of any product from U.A.W. is legal and free of restrictions in their home state. Customers shall warrant to U.A.W. that they are authorized to make purchases and that they are in full compliance with local, state and federal laws regarding restricted items. U.A.W. shall not be held liable for customer's use of such equipment. To verify legal restrictions on purchasing and using all such items, contact your local authorities.

There are no other warranties, expressed or implied, including but not limited to, any implied warranties of merchantability or fitness for a particular purpose. In no event shall U.A.W. be liable for any loss of profits or any indirect or consequential damages arising out of any such defect in material or workmanship.

Verifiable proof of occupation must be submitted for any purchase of police, sheriff & law enforcement items and accessories

LIGHTBAR WARRANTY

If you receive your package in a damaged condition, please refuse the package and immediately contact our customer service department. In order to file a claim, all damages must be reported within 24 hours of receipt.

- Warranty begins from date of purchase • Warranty of lightbar modules is 6 months and one year on hardware • Customer is responsible for all shipping on warranty repairs • After the warranty period the customer is responsible for all charges

U.A.W PHONE NUMBERS

US Orders.....877-643-1100
 USA & Non US Orders.....818-341-1500
 US Fax877-700-4477
 US & Non US Fax818-341-0015
 US Customer Service.....877-643-1100
 US & Non US Customer Service ..818-341-1500
 Internet Orders uniforms4all.com

WE DO TAILORING!

We tailor shirts, jackets and hem pants. We also do color pant stripping on pant legs. All our tailoring is done on site.

* No Minimum Order for tailored items

See page 128 for full details

WE EMBROIDER!



We do custom embroidery on shirts, hats and jackets. Call for details, scheduling and pricing. See page 128 for full details

WE ENGRAVE!



We now offer an engraving service. We make silver and gold metal name tags. We also have specialty name tags. Call for details and scheduling.

See pages 85-86

CUSTOM ID LABELS



Call for details and pricing

YOUR TEXT HERE

TABLE OF CONTENTS

NEW NEW NEW NEW4-7

BATONS..... 60-61

BADGES CUSTOM 63-68

BADGES STOCK 69-71

BODY ARMOR..... 125-126

CUSTOMIZING..... 128

DEFENSE SPRAY 62

DRESS UNIFORMS 33-39

DUTY GEAR 49-59

EMBLEMS CUSTOM 79-81

EMBLEMS STOCK 74-78

EMERGENCY EQUIPMENT 116-119

FLASHLIGHTS..... 7-12

FLYING CROSS UNIFORMS 40-42

FOOTWEAR 44-45

GUARDSCAN/METAL DETECTOR 87-91

HANDCUFFS..... 62

HEAD WEAR 47-48

INDEX 129-130

INSIGNIAS 72, 83-86

JACKETS 23-32

KNIVES 46

MEASURING & SIZE CHARTS 131

RADIOS 122-124

REFLECTIVE VESTS 120-121

SHIRTS 13-22

WARNING LIGHTS..... 92-115

WE SILK-SCREEN!



MINIMUM ORDER
 1 dozen (12) of the same item per order



Have us silk screen your company name, department, service etc. on to shirts, jackets and etc.

See page 128 for details

PROOF OF OCCUPATION

VERIFIABLE PROOF OF OCCUPATION MUST BE SUBMITTED FOR ANY PURCHASE OF POLICE, SHERIFF AND ANY LAW ENFORCEMENT ITEMS AND ACCESSORIES.

Tel: (877) 643-1100 ---- Toll Free
 Fax: (877) 700-4477 ---- Toll Free

(818) 341-1500 (US & NON US calls) PST
 (818) 341-0015 (US & NON US calls) PST

Phone Ordering
 M-F 7am - 5:30pm
 Sat 9am - 2pm

GS3000 PATROL TOUR SYSTEM

The Patrol Tour System features the latest in memory chip technology in the extremely durable GS3000 scanner. It is the ideal solution for companies wishing to track employees whose work duties require moving from place to place, such as security guard patrolling, policeman patrolling, remote equipment inspection, etc. The remote scanner records the date, time and tag ID when brought in contact with a button tag. Use the included Patrol Management Lite software to download and generate reports, which can be printed or exported to MS Word/Excel, PDF, JPG, and much more.

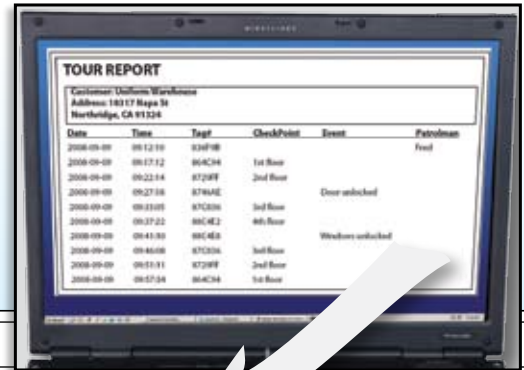

The Patrol Management Lite software is designed to be easy to use and setup. See the sample report.

TOUR REPORT

Customer: Uniform Warehouse
Address: 18317 Napa St
Northridge, CA 91324

| Date | Time | Tag# | CheckPoint | Event | Patrolman |
|------------|----------|--------|------------|------------------|-----------|
| 2008-09-09 | 09:12:10 | 836F9B | | | Fred |
| 2008-09-09 | 09:17:12 | 864C94 | 1st floor | | |
| 2008-09-09 | 09:22:14 | 8729FF | 2nd floor | | |
| 2008-09-09 | 09:27:18 | 8746AE | | Door unlocked | |
| 2008-09-09 | 09:33:05 | 87C836 | 3rd floor | | |
| 2008-09-09 | 09:37:22 | 88C4E2 | 4th floor | | |
| 2008-09-09 | 09:41:10 | 88C4E8 | | Windows unlocked | |
| 2008-09-09 | 09:46:08 | 87C836 | 3rd floor | | |
| 2008-09-09 | 09:51:11 | 8729FF | 2nd floor | | |
| 2008-09-09 | 09:57:34 | 864C94 | 1st floor | | |

- Durable stainless steel body with rubber grip is shock and water resistant
- Scanner records Date, Time, and ID information of each checkpoint visited
- Built-in battery lasts up to 400,000 scans (aprox. 2 years)
- Weight: 11.3 oz
- Size: 5¾" H x 1½" L x 1½" W
- Easy to use software



GS-3001
Base Unit
\$79⁹⁵

GS-3000 Scanner
\$119⁹⁵

Buy 100+ Scanners and save
10%



Tag & Holder

GS-3004
\$2⁵⁰



Tag Holder

GS-3003
\$0⁹⁹



Button Tags

GS-3002
\$1⁹⁵

PATROL TOUR SYSTEM SET

\$199⁹⁵ GS-3000A

Includes:

- 1 - Remote scanner
- 1 - Base unit
- 10-Button tags
- PM Lite software
- USB transfer cable

PADLOCKS AND KEY HOLDER LOCKS



4-DIGIT KEY HOLDER BOX

- Hold several keys inside the storage lock
- Keyless convenience: set your own 4-digit combination
- Key storage door pivots open smoothly and remains attached to the lock body for convenient operation
- Hardened steel shackle and zinc alloy body withstands hammering and sawing

\$19⁹⁵ each LK-01

4-DIGIT PADLOCK

- Set your own 4-digit combination
- Hardened steel shackle and zinc alloy body withstands hammering and sawing

\$4⁹⁵ each LK-03



3-DIGIT ALPHABETIC LOCK BOX

- Hold several keys inside the storage lock
- Set your own 3-digit alphabetic combination
- Hardened steel shackle and zinc alloy body withstands hammering and sawing

\$9⁹⁵ each LK-02



SHERIFF - EMS - FIRE DEPT POLYCOTTON POLO ID SHIRTS

- Short sleeve
- ID lettering on back of collar and both sleeves
- 3 button set-in placket front



PS-35
Grey Shirt
Black Text
SHERIFF

PS-36
Navy Blue Shirt
White Text
EMS

PS-37
Navy Blue Shirt
White Text
FIRE DEPT

\$9⁹⁵

Available sizes: Small to 5XL
Add \$4.00 for XL-5XL

MULTI-FUNCTION SAFETY TOOL

- Highly visible bright beacon • Visible to 550 yards • Flash rate 60 per minute • Requires 2AA batteries (not included)

\$9⁹⁵ each

FL-36



65/35 POLYCOTTON UNIFORM SHIRT

- Ideal for EMT, EMS, transit drivers & other attired personnel • 65/35 Polycotton blend for durability and comfort • Features shoulder epaulets and button-through flapped pockets



Short sleeve:
SCB-01

\$12⁹⁵

Add \$4.00 for XL-3XL;
Add \$7.00 for 4XL-5XL

SLIP-ON EPAULETS FOR SHIRTS & JACKETS

High quality slip on style epaulets for shirts and jackets.



\$4⁹⁵ per pair

Gold on black
E-67

Silver on black
E-66

Call for volume discount

CARRYALL DUTY GEAR BAG

REPLACEMENT EARTIPS



- Organizes all your duty needs
- Durable black nylon construction provides protection for all your gear
- Bag top includes two inside zippered pouches and six pen/pencil slots
- Three exterior open pockets and two zippered end pockets
- Size: 12" H x 18 1/2" W x 7 1/2" D

- Replacement eartips for headsets



99¢

each UA-13

\$24⁹⁵

BAG-01



PLAIN SHORT SLEEVE T-SHIRT

- 6 oz. 100% cotton • Double-needle bottom hem and sleeves • Shoulder-to-shoulder tape • Preshrunk to minimize shrinkage

\$3⁹⁵



PS-40

Color: White

Sizes:
Small-5XL
Add \$2.00 for
XL-2XL,
Add \$3.00 for
3XL-5XL

POLYESTER/SPANDEX TURTLENECK

- 7 oz. 95% Polyester/5% Spandex • Stretches to fit • Reinforced collar, sleeves and shoulder seams

\$14⁹⁵

PS-50B: Black

PS-50W: White

Sizes:
Small-5XL
Add \$2.00 for
XL-2XL,
Add \$3.00 for
3XL-5XL



FLEECE ZIP HOODIE

- 80% Cotton/20% Polyester • 2 side pockets • Lined with 100% polyester fleece • Front zipper: black

JS-11

Color: Black

\$14⁹⁵



Sizes: Small-5XL ; Add \$2.00 for XL-2XL,
Add \$3.00 for 3XL-5XL

FAUX FUR WINTER UNIFORM CAP

- Vinyl with faux fur lining • Flaps fold down to protect your ears from the cold • Insulated inner lining

\$14⁹⁵



HT-22

Color: Black

Sizes:
S, M, L, XL, 2XL

LEATHER CARE®

Complete cleaning and conditioning for finished leather goods without the sticky residue.

- Will not darken finished leather!
- Keeps leather soft and supple.
- Ideal for use on leather furniture, car interior, clothing, accessories - all smooth finished leathers!
- Safe on exotics
- 2 oz.



\$4⁹⁵

each LC-02

EDGE DRESSING ROLL CALL

Military grade edge dressing black, It renews original finish on heels and soles.

- Will darken finished leather
- Ideal for use on leather furniture, car interior, clothing, accessories and all smooth finished leathers
- Safe on exotics
- 4 oz.



\$9⁹⁵

each LC-03

KIWI BLACK POLISH

Work into leather and seams with a cloth or brush.

- Extends the life of the shoes • Gives a natural shine • Protects with the multi-wax-formula • 1 1/8 oz.



\$3⁹⁵

each LC-01

LED FLASHLIGHTS

THE NECESSITIES OF LIFE AT WORK, AT HOME, IN THE CAR . . .

RECHARGEABLE LUXEON LED FLASHLIGHT SET

Full size flashlight set with the **LUXEON** LED bulb
THE BRIGHTEST SINGLE BULB ON THE MARKET



Size: 13¼" long 2" lens

- Machined aircraft aluminium body
- Corrosion Resistant/Water Resistant/ Shock Resistant
- 3 Watt LED hyper bright Luxeon emitter
- 45 Lumens
- 100000 hour life for led bulb
- 1 rechargeable battery
- Range: 275 yards
- 3 Hours continuous working
- Charge time: 12 hours

\$39⁹⁵

FLD-21

REPLACEMENT BATTERY



FLB-05

\$12⁹⁵



Charge with AC adapter

TX-1 LED FLASHLIGHT

1 WATT LED Flashlight



- Machined aircraft aluminum body
- Intense 1 Watt LED
- Output: 45 lumens
- Continuous run time of 3 hours
- Includes 3 AAA batteries
- Size: 5 3/4" long 1" lens

FL-26

\$19⁹⁵

TX-2 XENON FLASHLIGHT

SUPER XENON FLASHLIGHT



- Rugged, black anodized finish provides resistance against corrosion
- Output 45 lumens
- Rear button on-off
- Continuous run time of 2 hours
- Includes 2 CR123A batteries
- Size: 5 1/2" long 1" lens

FL-25

\$19⁹⁵

TX-3 LED FLASHLIGHT

1 WATT LED Flashlight



- Lightweight durable aluminum body
- Intense 1 Watt LED
- Rear button on-off
- Output: 45 lumens
- Continuous run time of 4 hours
- Includes 2 CR123A batteries
- Size: 5 ¼" long 1" lens

FL-24

\$19⁹⁵

FIRST CLASS LED RECHARGEABLE FLASHLIGHT



NEW ITEM

FL-30

\$39⁹⁵

- Machined aircraft aluminum body
- Intense 3 Watt LED
- Output: 100 lumens
- Continuous run time of 3 hours
- Includes 3.6V rechargeable battery
- Indicator light shows full charge and charging
- Size: 5 3/4" long 1" lens



LEDs have 100,000 hour Lifetime!

RECHARGEABLE LED FLASHLIGHT SET

12 LED/HALOGEN RECHARGEABLE FLASHLIGHT SET



\$29⁹⁵

FL-04

Size: 12¼" long 1¾" lens

- High-grade aluminum alloy body with knurled grip
- Adjustable light projection
- Run time: Halogen 1.3 hours at 3500 candles
LED 12 hours
- Charge time: 8 hours Range: 275 yards at night
- 2 mode switch allows you to choose between high output 12 LEDs for short range, or halogen bulb for long range
- Includes cigarette lighter plug, AC adapter, rechargeable battery and spare bulb



2-D & 3-D CELL FLASHLIGHTS

- High-grade aluminum
- Adjustable light projection
- Extra bulb in tail cap
- Light-weight knurled grip



FL-01

Size: 12" long 2" lens

\$9⁹⁵

Purchase the 2-D cell for roadside emergencies.



FL-02

Size: 10¾" long 1¾" lens

\$8⁹⁵



6 + 1 ALUMINUM FLASHLIGHT

- High-grade aluminum body with rubberized hand grip
- 3 mode switch allows you to choose between high output LEDs or xenon bulb
- Long LED life and efficient power usage
- Water resistant
- Includes 3AAA batteries

\$9⁹⁵

FL-05



Size: 5½" long 1¾" lens

MINI LED FLASHLIGHT SETS WITH CASES

Size: 5" long 1" lens

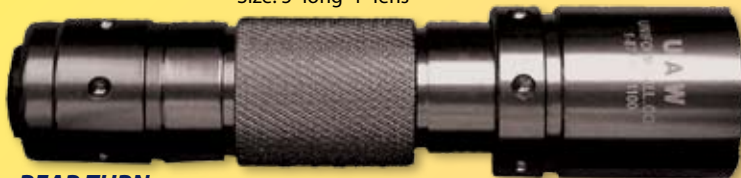

REAR TURN ON/OFF

1 XENON FLASHLIGHT

FL-07

\$9⁹⁵

6 LED FLASHLIGHT

FL-17

\$9⁹⁵

1 LED FLASHLIGHT EXTREMELY BRIGHT

FL-16

\$19⁹⁵

- High light output bulbs
- Depress tail cap for brief illumination
- High-grade aluminum body with knurled grip
- Includes 2 free lithium CR123A batteries and nylon case.



Tel: (877) 643-1100 ---- Toll Free
Fax: (877) 700-4477 ---- Toll Free

(818) 341-1500 (US & NON US calls) PST
(818) 341-0015 (US & NON US calls) PST

Phone Ordering
M-F 7am - 5:30pm
Sat 9am - 2pm

MAGLITES® FLASHLIGHTS

- High-intensity light beam from spot to flood with a twist of the wrist
- Rugged, machined aluminum construction with knurled design
- Anodized inside and out for improved corrosion resistance
- Water and shock resistant
- Spare lamp inside tail cap
- Long lamp life and efficient power usage
- Limited Lifetime Warranty
- Batteries not included

**3-D Cell Flashlights**

Size: 12¼" long 2" lens

FL-12

\$19⁹⁵

The Maglite® flashlights are now available with the new MAGLED™ Technology. All Maglite LED flashlights feature Balanced Optics™, combining a highly refined reflector with a quality LED, for a brilliant adjustable beam, and an Intelligent Energy Source Management balancing high brightness with efficient power usage.

3-D Cell LED Flashlights

Size: 12¼" long 2" lens

FL-31

\$29⁹⁵

- 3 Watt LED produces a powerful projecting beam that focuses simply by rotating the head
- Rugged, machined aluminum construction with knurled design
- Anodized inside and out for improved corrosion resistance
- Interchangeable Light Sourcing - use either the installed LED module or Krypton lamp (stored in the tailcap)
- Batteries not included

MAGLITES® - RECHARGEABLE FLASHLIGHT SYSTEM

Size: 12¼" long 2" lens

\$99⁹⁵

FL-32

Includes:

- 12V DC Charger
- 120V AC convertor
- Car charger
- Car & home mounting brackets for multiple charging locations
- 5 cell NI-CAD battery

Charging unit

- Easily replaces high-intensity halogen lamp
- Up to 51,700 candle power
- 6V rechargeable NiCad battery provides over 1,000 hours of operational life
- Continuous 2 hour run-time
- Highly polished, scientifically designed, metallic reflector, withstands extreme temperatures.
- Sleek black finish and precision machined high-strength aluminum alloy case
- Water resistant seals throughout for resistance to weather and harsh environmental conditions
- Individually serial numbered and limited lifetime warranty

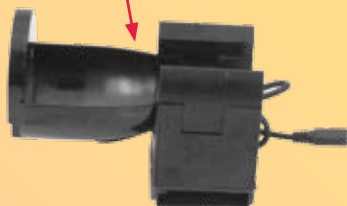
**NEW!**

2-AA CELL MINI-MAGLITES®

2-AA Cell Mini-Maglites®

Size: 5¾" long ¾" lens

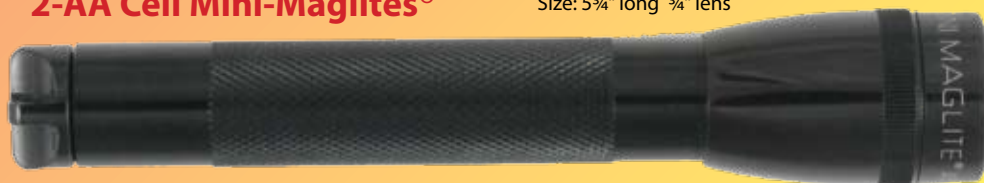

FL-35 **\$13⁹⁵**

- Super-Bright Krytron Lamp™ • Focusing beam lens • Easily converts to lamp mode by unscrewing the flashlight head • Includes belt holder and 2 AA batteries

2-AA Cell Mini-Maglite® LED

Size: 6½" long ¾" lens



FL-33 **\$19⁹⁵**

- Features a powerful 3 Watt LED in a compact size • Focusing beam lens • Easily converts to candle mode by unscrewing the flashlight head • Includes belt holder and 2 AA batteries

RECHARGEABLE FLASHLIGHT AND STUN GUN

- 800,000 volts
- Durable ABS plastic housing
- Slide on/off safety switch with separate firing button
- Built-in 7.2v rechargeable battery, LED light and slide in/out AC plug
- Includes nylon holder
- Size: 5½"L" x 2"W x 1"D

\$19⁹⁵

SG-01



Triggering switch

On/Off Indicator and switch

Retractable charging plug

COMPACT RECHARGEABLE STUN GUN & FLASHLIGHT

- 800,000 kv
- Durable ABS plastic housing
- Slide on/off safety switch with separate firing button
- Smooth contour grip
- Built-in rechargeable battery, LED light and slide in/out AC plug
- Includes nylon holder
- Size: 4½"L" x 2½"W x 1½"D

Retractable charging plug



\$19⁹⁵

SG-02



Triggering switch

On/Off switch

FLASHLIGHT HOLDERS

SEE MORE OPTIONS IN THE DUTY GEAR SECTION



Embossed grip flashlight holders

\$4⁹⁵ L-21

Also available:

Plain grip flashlight holder: **PL-08**

Nylon grip flashlight holder: **N-22**

Synthetic grip flashlight holder: **SL-21**

\$4⁹⁵

\$4⁹⁵

\$4⁹⁵



Embossed ring flashlight holders

\$3⁹⁵ L-19

Also available:

Plain ring flashlight holder: **PL-19**

Nylon ring flashlight holder: **N-19**

Synthetic ring flashlight holder: **SL-19**

6 LED ALUMINUM FLASHLIGHTS



Size: 5½" long ¾" lens

FL-23

\$9⁹⁵

- Side button turn on/off
- 6 LEDs

Includes 2 lithium batteries & nylon case



LED FLASHLIGHT SET

Flashlight takes 1 AA Battery
Aluminum encasing



Includes carrying case

FL-105

\$9⁹⁵

5 LEDs

Size: 3¼" long ¾" lens

LED HEAD LAMP

Plastic body
12 LEDs
Battery: 2AA



FL-11

\$9⁹⁵

LED KEY CHAIN

Key chain with Compass



FL-20

\$2⁹⁵

1 LED

Battery: 2 CR2016

LED UPGRADE MODULE



Upgrades any 3 cell C or D Maglite flashlight to a powerful LED beam. Simply replaces the existing bulb.



FL-34 **\$14⁹⁵**

We accept purchase orders from government institutions, corporations, universities and other companies upon credit approval.



POLYCOTTON UNIFORM SHIRTS

RETAINS A CRISP IMAGE IN A COMFORTABLE ALTERNATIVE

- Placket sleeve with center button (on long sleeve)
- Two button adjustable cuffs (on long sleeves)
- Placket front
- Double slit badge tab on left side of chest
- X-stitched shoulder epaulets
- Banded collar
- Two sewn-in creases in front & three sewn-in creases in back
- Two pleated pockets with pencil compartment on left pocket
- Hook & loop scalloped flaps with Velcro closure
- Seven front buttons
- Sizes: Small - 5XL



\$9⁹⁵

\$9⁹⁵

SC-30: Short-sleeve shirt
White Only

Add \$4.00 for 1XL-2XL; \$7.00 for 3XL-5XL

SC-08: Half-sleeve shirt
Lt Blue Only



\$9⁹⁵

LC-31: Long-sleeve shirt
Add \$4.00 for 1XL-2XL; \$7.00 for 3XL-5XL

PROFESSIONAL WHITE DRESS SHIRT

- Polycotton blend for durability and comfort
- Open left chest pocket • Replacement button included • Machine washable

Short sleeve: **SS-30**
\$8⁹⁵

Long sleeve: **LS-36**
\$9⁹⁵



Add \$3.00 for XL-3XL;
Add \$5.00 for 4XL-5XL

EMT WHITE SHIRT

- Ideal for emergency response, ambulance service, aviation & other attired personnel • Polycotton blend for durability and comfort • Features shoulder epaulets and button-through flapped pockets

Short sleeve: **EMT-01**



Pencil slot in left flapped pocket

\$9⁹⁵

Add \$4.00 for XL-3XL;
Add \$7.00 for 4XL-5XL

SHIRT SIZE CHART

| Small | Medium | Large | XL | XXL | 3XL | 4XL | 5XL |
|--------|--------|--------|--------|--------|--------|--------|--------|
| 14-14½ | 15-15½ | 16-16½ | 17-17½ | 18-18½ | 19-19½ | 20-20½ | 21-21½ |

Tel: (877) 643-1100 ---- Toll Free
Fax: (877) 700-4477 ---- Toll Free

(818) 341-1500 (US & NON US calls) PST
(818) 341-0015 (US & NON US calls) PST

Phone Ordering
M-F 7am - 5:30pm
Sat 9am - 2pm

100% POLYESTER TWO TONE UNIFORM SHIRTS

- Two pleated pockets with pencil compartment in left pocket
- Two sewn-in creases front & three sewn-in creases back
- Hook & loop scalloped flaps with Velcro closure
- Two button adjustable cuffs (on long sleeves)
- Placket front
- Double slit badge tab on left side of chest
- X-stitched shoulder epaulets
- Banded collar

See our slacks starting at page 33.

Short-sleeve



Long-sleeve



Retail \$17⁹⁵
PRICE REDUCTION NOW ONLY
\$7⁹⁵

White & Midnight Navy Blue 2-Tone Shirt featured with black tie

Retail \$18⁹⁵
PRICE REDUCTION NOW ONLY
\$9⁹⁵

Available in sizes: small - 5XL Add \$2.00 for 1XL-2XL; \$4.00 for 3XL-5XL

Available in sizes: small - 5XL Add \$3.00 for 1XL-2XL; \$5.00 for 3XL-5XL



We accept purchase orders from government institutions, corporations, universities and other companies upon credit approval.

| | | | | | |
|------------------|-------------------------------------------------------|------------------|------------------|----------------------------|-------------------------------------------------------|
| Available colors | Tan/brown | Light blue/black | Light Grey/black | White/Midnight Navy blue** | Dark grey/black* |
| Short Sleeve | TS-03 | TS-19 | TS-01 | TS-09 | TS-13 |
| Long Sleeve | Available in orders of 300 or more. Call for details. | TL-20 | TL-01 | TT-09 | Available in orders of 300 or more. Call for details. |

** White 2-tone shirt matches Navy Blue or Black slacks.

SHIRT SIZE CHART

| Small | Medium | Large | XL | XXL | 3XL | 4XL | 5XL |
|--------|--------|--------|--------|--------|--------|--------|--------|
| 14-14½ | 15-15½ | 16-16½ | 17-17½ | 18-18½ | 19-19½ | 20-20½ | 21-21½ |

100% POLYESTER UNIFORM SHIRTS

- Pleated Velcro patch pockets with scalloped flaps • Pen compartment in the left front pocket • Pointed collar with stays to keep your collar in place. • 5-point military creases & button down "X" stitched epaulets for uniformity
- Sturdy sling badge tab keeps badge in place • Placket sleeves include adjustable cuffs for comfort • Machine washable fabric resists stains and wrinkles



Retail \$17⁹⁵
PRICE REDUCTION NOW ONLY
\$7⁹⁵

Badge tab keeps badge in place



Retail \$18⁹⁵
PRICE REDUCTION NOW ONLY
\$8⁹⁵

Available in sizes: small - 5XL

SS-02: White Short-sleeve shirt

Add \$2.00 for XL-2XL; \$5.00 for 3XL-5XL

Available in sizes: small - 5XL

LS-03: Black Long-sleeve shirt

Add \$2.00 for XL-2XL; \$5.00 for 3XL-5XL

| Available Colors | White | Black | Navy Blue | Lt. Blue | Tan | Lt. Grey | Drk. Grey |
|-------------------------------------|--------------|--------------|--------------|--------------|--------------|--------------|--------------|
| Short Sleeve | SS-02 | SS-04 | SS-06 | SS-08 | SS-12 | SS-18 | SS-10 |
| Long Sleeve | LS-01 | LS-03 | LS-05 | LS-07 | LS-13 | LS-11 | LS-09 |
| Long Sleeve with zipper (close-out) | LS-20 | LS-22 | LS-24 | LS-26 | LS-34 | LS-32 | LS-28 |

HALF-SLEEVE 100% POLYESTER UNIFORM SHIRTS



\$6⁹⁵
 Small-4XL

BLOWOUT SALE

ALL SIZES SAME PRICE

- Extra long tail keeps shirt tucked-in
- Double slit badge tab
- Pen-pencil compartment
- X-stitched shoulder epaulets
- 5 sewn-in military creases, front & back
 - Permanent collar
- Pleated Velcro pockets with scalloped flaps

All sales are final and limited to stock on hand.
Call for availability

SHIRT SIZE CHART

| Small | Medium | Large | XL | XXL | 3XL | 4XL | 5XL |
|--------|--------|--------|--------|--------|--------|--------|--------|
| 14-14½ | 15-15½ | 16-16½ | 17-17½ | 18-18½ | 19-19½ | 20-20½ | 21-21½ |

Tel: (877) 643-1100 ---- Toll Free
Fax: (877) 700-4477 ---- Toll Free

(818) 341-1500 (US & NON US calls) PST
(818) 341-0015 (US & NON US calls) PST

Phone Ordering
 M-F 7am - 5:30pm
 Sat 9am - 2pm



LAPD CERTIFIED 100% WORSTED WOOL SHIRTS

SHORT SLEEVE

- Short sleeve shirts include a lined convertible collar with internal collar stays which ensures shirts appear sharp buttoned or unbuttoned
- Scalloped flap pockets complete with pen opening in left pocket
- Pocket flaps & shoulder straps, accommodate metal buttons
- Metal badge eyelets
- Satin inner yoke & collar band for comfort
- Extra long tails keep shirt neatly in place
- Dry-clean only



\$49⁹⁵

Available in neck sizes: 14½" - 22"
Add \$10.00 for 19-20"; \$15.00 for 22"

NBL-01: Men's Short Sleeve navy blue
NBL-51: Women's Short Sleeve navy blue

LONG SLEEVE

- Long-sleeve features a lined banded dress collar with internal collar stays and "banjo" patch elbows
- Long-sleeve features lined convertible collar & internal collar stays.
- Scalloped flap pockets complete with pen opening in left pocket
- Pocket flaps & shoulder straps, accommodate metal buttons
- Satin inner yoke & collar band for comfort
- Extra long tails keep shirt neatly in place
- Dry-clean only

\$59⁹⁵

Available in neck sizes: 14½" - 22"
Sleeve length: 32" - 37"
Add \$12.00 for 19-20"; \$15.00 for 22"

NBL-02: Men's Long Sleeve navy blue
NBL-52: Women's Long Sleeve navy blue

Additional Services Available: Shirts available with zippered front for an additional \$6.95.

SHORT-SLEEVE 65% POLYESTER & 35% RAYON UNIFORM SHIRTS

- Poly-rayon fabric delivers the best in comfort and durability
- Convenient Velcro pleated patch pockets with scalloped flaps create a crisp image
- Pen compartment is provided in the left front pocket
- Pointed collar features stays keeping your collar in place
- 5-point military creases & button down "X" stitched epaulets
- 7-button placket front
- Sturdy sling badge tab keeps badge in place



\$12⁹⁵ Small-5XL

PRS-04: Black

PRS-03: Border Patrol Green

PRS-05: Tan

PRS-02: White

PRS-01: French Blue

PRS-06: Navy Blue

Add \$4.00 for 1XL-2XL; \$7.00 for 3XL-5XL

SHIRT SIZE CHART

| Small | Medium | Large | XL | XXL | 3XL | 4XL | 5XL |
|--------|--------|--------|--------|--------|--------|--------|--------|
| 14-14½ | 15-15½ | 16-16½ | 17-17½ | 18-18½ | 19-19½ | 20-20½ | 21-21½ |

100% WOOL ELBECO LAPD SHIRTS

- 100% Wool • Short sleeve • Button front • Heavy weight

\$69⁹⁵



NBHW-01
LAPD Blue only

Available in:
Sml, Med, Lrg,
Xl, 2LX, 3XL
and 4XL

Add \$7.00
for XL-4XL

BDU SHIRTS

- Polyester-cotton blend rip stop shoulder epaulets with button
- Easy-access button closure
- Adjustable 2 button sleeves
- 2 front pockets with flap and button closure
- Long sleeve
- Left pocket pencil slot
- Machine wash & dry

\$14⁹⁵

Add \$4.00
for XL - 5XL



BSH-01: Black **BSH-04: Navy Blue**
For a complete uniform, wear with BDU pants. See page 36

BDU SWEATER VEST



\$14⁹⁵

Add \$4.00 for XL-5XL

BSV-03: Black • Machine washable
BSV-05: Navy Blue • Sleeveless

BDU SWEATER



\$19⁹⁵

Add \$4.00 for XL-5XL

BSW-01: Black • Fully reinforced with twill fabric patches on the sleeve and elbow
BSW-04: Navy Blue • Machine washable
BSW-06: Green • V-neck/badge tab

SHIRT SIZE CHART

| Small | Medium | Large | XL | XXL | 3XL | 4XL | 5XL |
|--------|--------|--------|--------|--------|--------|--------|--------|
| 14-14½ | 15-15½ | 16-16½ | 17-17½ | 18-18½ | 19-19½ | 20-20½ | 21-21½ |

Tel: (877) 643-1100 ---- Toll Free
Fax: (877) 700-4477 ---- Toll Free

(818) 341-1500 (US & NON US calls) PST
(818) 341-0015 (US & NON US calls) PST

Phone Ordering
M-F 7am - 5:30pm
Sat 9am - 2pm

POLYCOTTON SECURITY POLO SHIRTS

Without Security ID on front and back

- SECURITY lettering on collar and sleeves
- 3 button set-in placket front
- Vented sides
- Embroider or silk screen your name and logo (See page 3)



Available sizes:
Small to 5XL

\$9⁹⁵

Add \$3.00 for XL-3XL; \$5.00 for 4XL-5XL

Available colors: **SP-21: White** **SP-23: Black** **SP-25: Navy Blue**

With Security ID in front and back

- 3" SECURITY silk screened on back
- 1½" SECURITY lettering on left chest
- SECURITY lettering on collar and sleeves
- 3 button set-in placket front/vented sides



\$9⁹⁵

Available sizes:
Small to 5XL

Add \$3.00 for XL-3XL; \$5.00 for 4XL-5XL

Available colors: **SP-30: White** **SP-32: Black** **SP-34: Navy Blue**

PRESHRUNK COTTON POLO SHIRTS



\$7⁹⁵

PS-04: Red

White, black, navy blue, heather grey, red and sand available up to 5XL. All other colors available up to 2XL.
Add \$2.00 for XL-3XL; \$4.00 for 4XL-5XL

BRINGING A NEW LEVEL OF COMFORT TO YOUR UNIFORM.

- 100% preshrunk cotton
- Reinforced stitching along seams
- Vented sides for secure tucking
- Cool & comfortable
- Embroider or silk screen your name and logo (See page 3)



PS-01: White

PS-03: Black

PS-02: Cream

PS-05: Navy Blue

Available sizes: Small to 5XL

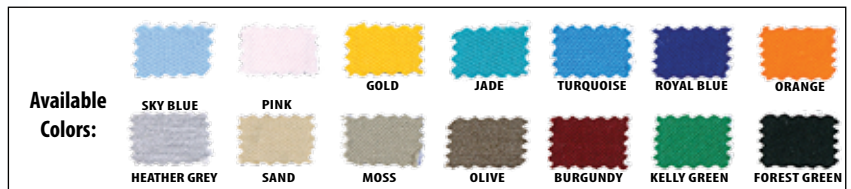

Available Colors:

Please indicate color when ordering shirts with no item code.

SHIRT SIZE CHART

| Small | Medium | Large | XL | XXL | 3XL | 4XL | 5XL |
|--------|--------|--------|--------|--------|--------|--------|--------|
| 14-14½ | 15-15½ | 16-16½ | 17-17½ | 18-18½ | 19-19½ | 20-20½ | 21-21½ |

POLYCOTTON LARGE ID POLICE & SHERIFF POLO SHIRTS



- 4" ID silk screened on back
- 2" ID lettering on left chest
- ID lettering on sleeves and back of collar
- 3 button set-in placket front
- Vented sides

Available sizes: Small to 5XL



\$9⁹⁵ **PP-35: White**

Add \$3.00 for XL-3XL;
\$5.00 for 4XL-5XL

Available colors:

PP-35: White **PP-36: Black** **PP-37: Navy Blue**

SHP-40: White

\$9⁹⁵

Add \$3.00 for XL-3XL;
\$5.00 for 4XL-5XL

Available colors: **SHP-40: White** **SHP-41: Black** **SHP-42: Navy Blue**

POLYCOTTON POLICE & SHERIFF ID POLO SHIRTS



- POLICE or SHERIFF ID lettering on collar and sleeves
- 3 button set-in placket front
- Vented sides



POLICE
PP-38: White
\$9⁹⁵

Available sizes: Small to 5XL

SHERIFF
SHP-35: White
\$9⁹⁵

Add \$3.00 for XL-3XL; \$5.00 for 4XL-5XL

Add \$3.00 for XL-3XL; \$5.00 for 4XL-5XL

Available colors: **PP-38: White** **PP-39: Black** **PP-40: Navy Blue**

Available colors: **SHP-35: White** **SHP-36: Black** **SHP-37: Navy Blue**

SHIRT SIZE CHART

| Small | Medium | Large | XL | XXL | 3XL | 4XL | 5XL |
|--------|--------|--------|--------|--------|--------|--------|--------|
| 14-14½ | 15-15½ | 16-16½ | 17-17½ | 18-18½ | 19-19½ | 20-20½ | 21-21½ |

Tel: (877) 643-1100 ---- Toll Free
Fax: (877) 700-4477 ---- Toll Free

(818) 341-1500 (US & NON US calls) PST
(818) 341-0015 (US & NON US calls) PST

Phone Ordering
M-F 7am - 5:30pm
Sat 9am - 2pm

POLYCOTTON SECURITY POLO SHIRTS

With Security ID in front and back

- 3" SECURITY silk screened on back
- 1½" SECURITY lettering on left chest
- 3 button set-in placket front/vented sides

\$9⁹⁵

Available sizes:
Small to 5XL

PS-10: White



Add \$3.00 for XL-3XL; \$5.00 for 4XL-5XL

100% COTTON T-SHIRTS WITH ID

SHORT SLEEVED T-SHIRT

With Security ID in front and back



PS-08: White

\$6⁹⁵

PS-09: Black

Available in sizes: Small - 5XL

Add \$3.00 for XL-3XL; \$5.00 for 4XL-5XL

100% COTTON POLICE POLO SHIRTS

THESE POLO SHIRTS BRING A NEW LEVEL OF COMFORT TO YOUR UNIFORMS

- 100% preshrunk cotton
- Reinforced stitching along seams
- Vented sides for secure tucking
- Cool & comfortable
- Embroider or silk screen your name and logo (See page 3)



PP-42: Navy Blue & Gold Text



PP-43 White



PP-41
Heather Grey

\$9⁹⁵

Available sizes:
Small to 5XL

Add \$3.00 for XL-2XL; \$5.00 for 3XL-4XL

SHIRT SIZE CHART

| Small | Medium | Large | XL | XXL | 3XL | 4XL | 5XL |
|--------|--------|--------|--------|--------|--------|--------|--------|
| 14-14½ | 15-15½ | 16-16½ | 17-17½ | 18-18½ | 19-19½ | 20-20½ | 21-21½ |

POLYCOTTON SECURITY POLO SHIRTS WITH ID FRONT & BACK

• 3" SECURITY silk screened on back • 1½" SECURITY lettering on left chest • 3 button set-in placket front/vented sides



PS-11 Black & White Text **PS-15 Navy Blue & White Text** **PS-12 Navy Blue & Gold Text** **PS-14 Heather Grey & Black Text** **PS-13 Yellow & Navy Blue Text**

Add \$3.00 for XL-3XL; \$5.00 for 4XL-5XL

\$8⁹⁵ Available sizes: Small to 5XL

PS-10 White & Black Text

We offer many more combinations. Please call for complete details.

3 COLOR POYCOTTON POLO SHIRTS

• 75% Cotton 25% Polyester • Available in White, Black, Navy Blue, Sand & Heather Grey Colors • 100% Preshrunk Polo Shirts • Cool & Comfortable • 3 button set-in placket front • Available sizes : Small to 2XL



PS-16 Black & Grey Collar/Cuffs **PS-18 Sand & Tan Collar/Cuffs** **PS-19 Heather Grey & Grey Collar/Cuffs** **PS-34 White & Grey Collar/Cuffs**

Add \$4.00 for XL-2XL

\$8⁹⁵ Available sizes: Small to 2XL

PS-17 Navy Blue & Grey Collar/Cuffs

SHIRT SIZE CHART

| Small | Medium | Large | XL | XXL | 3XL | 4XL | 5XL |
|--------|--------|--------|--------|--------|--------|--------|--------|
| 14-14½ | 15-15½ | 16-16½ | 17-17½ | 18-18½ | 19-19½ | 20-20½ | 21-21½ |

Tel: (877) 643-1100 ---- Toll Free
Fax: (877) 700-4477 ---- Toll Free

(818) 341-1500 (US & NON US calls) PST
(818) 341-0015 (US & NON US calls) PST

Phone Ordering
 M-F 7am - 5:30pm
 Sat 9am - 2pm

SHERIFF SHIRTS - CLASS A

ACADEMY CLASS (CLASS A)

- Tropical Weave
- 55% polyester & 45% worsted wool
- Reinforced elbows & double-needle stitching throughout
- Metal badge eyelet

STS-03: Short Sleeve class A

\$34.95

Available in neck sizes: 14½" - 21½"

Add \$7.00 for 19" 20";
\$14.00 for 21"-22"



STS-02: Long Sleeve class A

\$59.95

Available in neck sizes: 14½" - 22"

Add \$7.00 for 19"-20"; \$14.00 for 21"-22"

SHERIFF SHIRTS - CLASS B

SHERIFF DEPARTMENT (CLASS B)



- Poplin Weave
- 65% polyester & 35% cotton
- Top-fused convertible collar with internal stays
- Plain rounded pockets, scalloped flaps, hook & loop closures

\$21.95

STS-01: Short Sleeve Class B

Available in neck sizes: 14½" - 22"

Add \$4.00 for 19" 20";
\$8.00 for 21"-22"

100% WORSTED WOOL UNIFORM SHIRTS

SHORT SLEEVED SHIRT

MODELED AFTER THE LAPD UNIFORM SHIRT

- X-stitched epaulets
- Lined collar
- Metal badge eyelet
- Scalloped pockets
- Zipper with faux button
- Double needle stitched seams
- Satin inner yoke & collarband for comfort



Retail Price

~~\$39.99~~

\$19.95

WS-01:

Navy Blue Short-Sleeve Wool Shirt

Available in sizes: Small - 4XL

Add \$2.00 for XL-2XL;
\$5.00 for 3XL-4XL



SHIRT SIZE CHART

| Small | Medium | Large | XL | XXL | 3XL | 4XL | 5XL |
|--------|--------|--------|--------|--------|--------|--------|--------|
| 14-14½ | 15-15½ | 16-16½ | 17-17½ | 18-18½ | 19-19½ | 20-20½ | 21-21½ |

ALL SEASON DELUXE JACKET

- 100% Nylon Oxford water-repellent and windproof outer shell
- Removable inner lining with 100% polyester fiberfill provides warmth and comfort
- Option of 3 concealable pull down, high visibility identifier panels with zipper (sold separately see below)
 - 2 small front identifiers & - 1 large back identifier
- 5 color matching button snaps conceals original YKK zipper for a clean frontal appearance
- Dense removable high quality faux fur collar completely insulates throat when collar is up
- Adjustable Velcro shell conceals knit wristlets
- Removable hood with insulated fiberfill cushioning
- Shoulder epaulets and 2 pleated front pockets
- 9" side zippers for easy access to duty belt
- Trimmed with gold buttons
- Back elastic waistband for size adjustment and flexibility
- 3 inside pockets (1 stiff pocket with snap and 2 secure inside pockets)



Shown with 2 removable small front reflective identifiers (1 left - 1 right) IDJS-01



Color Matching Front Snaps



Removable collar, hood and lining



Metal eyelet badge tab

9" side zipper on each side



Shown with large, optional, removable, back reflective identifier IDJS-04

Retail Price \$99⁹⁵
PRICE REDUCTION NOW ONLY
\$39⁹⁵

Navy Blue: JSID-04

Green : JSID-05

Brown: JSID-06

Black: JSID-02

Add \$5.00 for XL - 2XL, Add \$7.00 3XL - 4XL

Available in sizes: • Small • Medium • Large • 1XL • 2XL • 3XL •4XL

\$4⁹⁵ Front: Each
 Dimensions: 7¼" x 3"

Customize this jacket with the following reflective identifiers.

\$9⁹⁵ Back: Each
 Dimensions: 15½" x 4½"

| | EMS | EMT | SAFETY OFFICER | SECURITY | POLICE | YOUR OWN TITLE* |
|-------|----------|---------|----------------|-----------------|--------------------|---------------------------------------|
| FRONT | IDJS-01 | IDJS-03 | IDJS-05 | IDJS-07 | IDJS-09 | IDJS-30 \$14⁹⁵ Each |
| BACK | IDJS-02 | IDJS-04 | IDJS-06 | IDJS-08 | IDJS-10 | IDJS-31 \$19⁹⁵ Each |
| | K-9 UNIT | SHERIFF | CROSSING GUARD | TRAFFIC CONTROL | TOW TRUCK OPERATOR | FIRE DEPT. |
| FRONT | IDJS-11 | IDJS-13 | IDJS-15 | IDJS-17 | IDJS-19 | IDJS-21 |
| BACK | IDJS-12 | IDJS-14 | IDJS-16 | IDJS-18 | IDJS-20 | IDJS-22 |

For additional identifiers see our web site: www.uniforms4all.com

Tel: (877) 643-1100 ---- Toll Free
 Fax: (877) 700-4477 ---- Toll Free

(818) 341-1500 (US & NON US calls) PST
 (818) 341-0015 (US & NON US calls) PST

Phone Ordering
 M-F 7am - 5:30pm
 Sat 9am - 2pm

ALL SEASON DELUXE JACKET

- 100% Nylon waterproof, windproof and breathable outer shell for comfort and protection from the weather
- Removable micro fleece inner lining provides warmth and comfort
- 3 concealable pull down, high visibility identifier panels with zipper (IDs sold separately see below)
 - 2 small front identifiers & - 1 large back identifier
- 6 color matching snaps help conceal the front zipper
- Closes at top to completely insulates throat when collar is up

- Adjustable snaps at wrists
- Concealed hood in collar permanent
- Shoulder epaulets and 2 plated front pockets
- 9" side vent zippers for easy access to duty belt
- Back elastic waistband for size adjustment and flexibility
- 2 inside zippered pockets and 2 separate pockets in the lining
- Many concealed 2-way fleece lined hand warmer pockets
- Machine washable

Removable insulated all weather lining

2 inside zippered pockets & 2 in lining also

Concealed hood

1 large optional removable back reflective identifiers IDJS-10 Shown

Combination sweater and snap style cuffs.

2 areas for small reflective identifiers (1 left - 1 right) IDJS-13 Shown

2 fleece lined concealed pockets each side

1 concealed zippered pockets each side

9" side zipper on each side

Adjustable opening for easy duty gear access

Retail Price \$99⁹⁹

PRICE REDUCTION NOW ONLY \$69⁹⁵

JSID-10: Black
Add \$5.00 for XL - 2XL,
Add \$7.00 3XL - 4XL

ADD REFLECTIVE IDENTIFIERS
See page 23 and 28

LEATHER BOMBER JACKET

- Top-grain genuine leather
- Removable quilted lining for warmth and comfort
- Full-zipper and two-button front closure
- Removable faux fur collar adds warmth and style
- Point collar and shoulder epaulets with snaps
- Elastic waist for snug fit
- Adjustable snap closure on wrists
- Features two lower pockets with snap flaps and slash pockets
- Pen compartment in right pocket

Available in sizes:

• Small • Medium • Large • 1XL • 2XL • 3XL • 4XL



Retail Price

\$99⁹⁹

\$69⁹⁵

JS-09: Black

Add \$3.00 for XL - 2XL,

Add \$5.00 3XL - 4XL



ALL SEASON DELUXE BOMBER JACKET

- Premium water-repellent 100% Nylon Oxford shell for superior protection
- Removable inner lining with 100% polyester fiberfill provides comfort and warmth
- 5 color matching button front snaps conceals original YKK zipper for a clean frontal appearance
- Dense removable high quality faux fur

- collar completely insulates throat when worn in the upright position
- Adjustable Velcro shell conceals knit wristlets
- Removable hood with insulated fiberfill cushioning
- Shoulder epaulets
- 9" size zippers for easy access to gear
- Badge tab with metal eyelet

- 2 pleated front pockets
- Trimmed with gold buttons
- Back elastic waistband for size adjustment and flexibility
- 3 inside pockets (1 stiff pocket with snap and 2 secure inside pockets)



Removable inner lining with zipper

9" side zipper on each side

Color Matching Front Snaps

Metal eyelet badge tab

\$19⁹⁵

JSH-02: Black

Add \$3.00 for XL - 2XL, Add \$5.00 3XL - 4XL

GOLD & SILVER REPLACEMENT BUTTONS



BN-03



BN-05

Set of 6 **\$4⁹⁵**

Available in sizes: • Small • Medium • Large • 1XL • 2XL • 3XL • 4XL

Add \$3.00 for XL - 2XL, Add \$5.00 3XL - 4XL



JSH-06: Brown

\$29⁹⁵



JSH-04: Navy Blue

\$24⁹⁵



JSH-05: Green

\$29⁹⁵

REFLECTIVE STRIPES FOR WINDBREAKER



We can add this reflective stripe to any of our existing windbreaker jackets. It goes completely around jacket at chest height. It just adds \$9.00 to the price of the jacket

We accept purchase orders from government institutions, corporations, universities and other companies upon credit approval.



Tel: (877) 643-1100 ---- Toll Free
 Fax: (877) 700-4477 ---- Toll Free

(818) 341-1500 (US & NON US calls) PST
 (818) 341-0015 (US & NON US calls) PST

Phone Ordering
 M-F 7am - 5:30pm
 Sat 9am - 2pm

WATCH-GUARD BOMBER JACKET

Without hindering your mobility, our lightweight jackets feature warm insulation & tough outer linings. 100% polyester fiberfill cushions the nylon inner linings of our bomber jackets. Our jackets retain their shape & resist the elements with a 100% Nylon Oxford covering.

- Windproof & insulated, this jacket provides complete warmth with permanent faux fur collar
- A clean frontal appearance
- Scalloped pockets include concealed hand-warmers
- Jacket retains shape with a sturdy elastic waistband



JS-01: Black JS-04: Navy Blue JS-05: Green JS-06: Brown

Retail \$29⁹⁵
PRICE REDUCTION NOW ONLY
\$15⁹⁵

Black Only
Add \$4.00 for other colors

Available in sizes:
 • Small • Medium • Large
 • 1XL • 2XL • 3XL • 4XL
 Add \$3.00 for XL- 2XL;
 \$5.00 for 3XL - 4XL

HIGH VISIBILITY FLUORESCENT REFLECTIVE JACKET

- Lightweight and durable • Water resistant 100% Nylon shell • Multiple reflective stripes • Hood easily stored in collar pouch • Bright high visibility colors • Elastic cuffs and waistband to seal out the elements • Metal badge tab eyelets • 1 inside chest pocket • 2 deep outside hand pockets • Side zipper provides easy access to duty gear • 4" raisable collar



\$29⁹⁵

\$19⁹⁵

JS-203: Orange

JS-204: Yellow

Available in sizes:
 • Small • Medium • Large
 • 1XL • 2XL • 3XL • 4XL • 5XL
 Add \$5.00 for XL - 2XL,
 Add \$7.00 3XL - 5XL

FP-01: Pants Yellow
FP-02: Pants Orange

Available in sizes: SML - 4XL
 Add \$3.00 for XL-2XL;
 \$5.00 for 3XL-4XL

TRI-COLOR JACKETS IN ANSI/ISEA 107-1999 STANDARDS

- Completely resistant to the elements
- Heavily padded
- Additional soft & warm collar padding
- Hood easily stored in collar pouch



- Storage pocket, cell-phone pocket and pen and pencil compartment
- Adjustable cuffs to seal-out the elements
- Easy access to your duty belt
- Adjustable waist

AFFORDABLE

\$39⁹⁵

Add \$3.00 for XL - 2XL,
Add \$5.00 3XL - 5XL

JS-101: Fluorescent Tricolor

Available in sizes:

- Small • Medium • Large
- 1XL • 2XL • 3XL • 4XL • 5XL

REVERSIBLE RAIN JACKETS

- Light-weight and durable
- Rain resistant deep lined pockets

AFFORDABLE



Metal badge tab eyelets on each side

Easy access to your duty belt

Two deep, hand-warming pockets found on each side

\$39⁹⁵

JS-202: Fluorescent Reversible jacket

Fully lined

Adjustable waist

Available in sizes:

- Small • Medium • Large
- 1XL • 2XL • 3XL • 4XL • 5XL

Add \$3.00 for XL - 2XL,
Add \$5.00 3XL - 5XL

RAIN PANTS



\$19⁹⁵

FP-01: Pants Yellow
FP-02: Pants Orange

Available in sizes: small - 4XL
Add \$3.00 for XL - 2XL;
\$5.00 for 3XL - 4XL

ALL SEASON HIGH VISIBILITY DELUXE JACKET

- 100% Nylon Oxford water-repellent and windproof outer shell
- Removable inner lining with 100% polyester fiberfill provides warmth and comfort
- Area for 3 concealable pull down, high visibility identifier panels with zipper (sold separately see below)
 - 2 small front identifiers & - 1 large back identifier
- 6 black button snaps conceal original zipper for a clean frontal appearance
- Dense collar completely insulates throat when worn in the upright position
- Adjustable Velcro shell tightens at the wrists
- Removable rain hood stores inside back of collar
- Side zippers open to armpit for easy access to duty gear
- 2 outer pockets with Velcro closure of easy access

ADD REFLECTIVE IDENTIFIERS

Bright yellow highly reflective material for safety



Removable hood with zippered storage

Reflective striping



2 optional removable small front identifiers (1 left - 1 right) IDJS-09 Shown

Side zippers open to armpit on each side

Removable lining

Available in sizes:

- Small • Medium • Large
- 1XL • 2XL • 3XL • 4XL • 5XL
- Add \$3.00 for XL- 2XL;
- \$5.00 for 3XL - 5XL



1 large optional removable back identifiers IDJS-10 Shown

JS-07

Retail \$99⁹⁵
PRICE REDUCTION NOW ONLY
\$49⁹⁵

Add \$5.00 for XL - 2XL, Add \$9.00 3XL - 5XL



\$4⁹⁵ Front: Each **Customize this jacket with the following reflective identifiers.** **\$9⁹⁵** Back: Each

Dimensions: 7 1/4" x 3"

Dimensions: 15 1/2" x 4 1/2"

| | EMS | EMT | SAFETY OFFICER | SECURITY | POLICE | YOUR OWN TITLE* |
|--------------|----------|---------|----------------|-----------------|--------------------|---------------------------------------|
| FRONT | IDJS-01 | IDJS-03 | IDJS-05 | IDJS-07 | IDJS-09 | IDJS-30 \$14⁹⁵ Each |
| BACK | IDJS-02 | IDJS-04 | IDJS-06 | IDJS-08 | IDJS-10 | IDJS-31 \$19⁹⁵ Each |
| | K-9 UNIT | SHERIFF | CROSSING GUARD | TRAFFIC CONTROL | TOW TRUCK OPERATOR | FIRE DEPT. |
| FRONT | IDJS-11 | IDJS-13 | IDJS-15 | IDJS-17 | IDJS-19 | IDJS-21 |
| BACK | IDJS-12 | IDJS-14 | IDJS-16 | IDJS-18 | IDJS-20 | IDJS-22 |

For additional identifiers see our web site: www.uniforms4all.com *Additional charges may apply. Call for details.

HIGH VISIBILITY WINDBREAKER

- Bright high visibility yellow
- Water resistant 100% Nylon shell
- Reflective striping
- Optional 3 concealable identifiers (2 front & 1 rear)
- Elastic cuffs and draw string waistband

\$24⁹⁵ WBID-01



See page 27



Available in sizes: • Small • Medium • Large • 1XL • 2XL • 3XL • 4XL
Add \$5.00 for XL-2XL, Add \$7.00 for 3XL-4XL

**HAVE US CUSTOMIZE YOUR JACKETS OR SHIRTS
HAVE US ADD IDENTIFYING PATCHES FOR ONLY**

\$4⁹⁵

Any small and large patch sewn onto the front and back on the same order

See patches featured on pages 74-81



Shown with US Flag E-02

Shown with Security patch E-100

ALTERING AVAILABLE
See page 128

REMOVE FROM CATALOG PAGE 11/2

Tel: (877) 643-1100 ---- Toll Free
Fax: (877) 700-4477 ---- Toll Free

(818) 341-1500 (US & NON US calls) PST
(818) 341-0015 (US & NON US calls) PST

Phone Ordering
M-F 7am - 5:30pm
Sat 9am - 2pm

ELITE WINDBREAKER JACKET WITH SECURITY ID

100% NYLON, 5 CONVENIENT POCKETS

Our light-weight windbreaker offers equivalent features found in expensive brands.

STOCK EMBLEM SECURITY ID

Includes a small police or security patch applied on front and a large patch applied on the back.

Select your style from pages 74-75 & 77



Available in sizes:
 • Small • Medium • Large
 • 1XL • 2XL • 3XL • 4XL • 5XL

\$19⁹⁵

Add \$3.00 for XL - 3XL,
 Add \$5.00 4XL - 5XL

Back view with emblem

JS-20: Black JS-22: Navy

SILK-SCREENED SECURITY ID

Front: Silk-screened U.S. Flag on right & metal eyelet badge tab on left.

Back: White "SECURITY" identification (3½" H x 14" L)



\$16⁹⁵

Add \$3.00 for XL - 3XL,
 Add \$5.00 4XL - 5XL

Silk-screened back view

JS-16: Black w/ID JS-18: Navy Blue w/ID

ELITE WINDBREAKER JACKET WITHOUT SECURITY ID

Plenty of Storage . . .

- Two pleated patch pockets with breast flaps provide a well-groomed look
- Left front pocket includes pen holder
- Additional utility side pockets
- Inside left chest pocket gives extra storage capacity

\$15⁹⁵

Add \$4.00 for XL - 3XL,
 Add \$7.00 4XL - 5XL

Available in sizes:

- Small • Medium • Large
- 1XL • 2XL • 3XL • 4XL • 5XL



JS-15: Black JS-17: Navy Blue

- Elastic waistband procures a trimmed fit leaving the front smooth
- Adjustable button cuffs
- Gold buttons close the 2 front pockets & shoulder epaulets



ELITE WINDBREAKER WITH POLICE ID

- 100% Nylon
- Two pleated pockets with breast flaps provide a well-groomed look
- Left front pocket includes pen holder
- Additional utility side pockets
- Inside left chest pocket gives extra storage capacity
- Elastic waistband creates a trim fit
- Adjustable button cuffs
- Gold buttons trim 2 front pockets & shoulder epaulets

Customize your elite windbreaker with your custom emblem or stock police emblems on page 74-75 & 77

\$14⁹⁵

Add \$3.00 for 2XL - 3XL,
Add \$5.00 3XL - 4XL

JS-24: Black JS-25: Navy Blue



Available in sizes:
• Small • Medium • Large
• 1XL • 2XL • 3XL • 4XL

POLICE & SHERIFF WINDBREAKER

- OPTIMIZED COMFORT WITH
- 100% COTTON LINER
- 100% NYLON OUTER SHELL
- 100% WATER RESISTANT

- Extended length to guard hips
- Elastic cuffs
- Six color matching front snaps

With Police ID:
Front "POLICE" text is 4 1/2"W X 1 1/4"H
Back "POLICE" text is 14"W x 3"H

\$14⁹⁵

Add \$3.00 for XL - 2XL,
Add \$5.00 3XL - 5XL

With Police IDs
WB-08: Black WB-12: Navy Blue

With Sheriff IDs
WBSH-01: Black

Available in sizes:
• Small • Medium • Large
• 1XL • 2XL • 3XL • 4XL • 5XL



Also available in Red, Yellow, Green and Orange. Call for details!

Tel: (877) 643-1100 ---- Toll Free
Fax: (877) 700-4477 ---- Toll Free

(818) 341-1500 (US & NON US calls) PST
(818) 341-0015 (US & NON US calls) PST

Phone Ordering
M-F 7am - 5:30pm
Sat 9am - 2pm

PLAIN WINDBREAKERS

**OPTIMIZED COMFORT WITH 100% COTTON LINER
100% NYLON OUTER SHELL – 100% WATER RESISTANT!**

- Extended length to guard hips • Elastic cuffs • Six color matching front snaps



**WB-17
Yellow**

**WB-16
Red**

**WB-03
Black**

**WB-18
Green**

**WB-19
Orange**

Available in sizes:

- Small • Medium • Large • 1XL • 2XL • 3XL • 4XL • 5XL

Add \$3.00 for XL - 2XL, Add \$5.00 3XL - 5XL



\$9⁹⁵ Black and Navy Blue Only
Add \$3.00 for other colors

WB-09 Navy Blue

WB-03 Black with reflective stripe

Add \$9.00 for a reflective stripe completely around jacket on all colors

ID WINDBREAKERS

**OPTIMIZED COMFORT WITH 100% COTTON LINER
100% NYLON OUTER SHELL – 100% WATER RESISTANT!**

- Extended length to guard hips With ID: Front "SECURITY"
- Elastic cuffs Text is 4½" W x 1¼" H.
- Six color matching front snaps Back "SECURITY" Text is 14" W x 3"H

Available in sizes:

- Small • Medium • Large • 1XL • 2XL • 3XL • 4XL • 5XL

Add \$3.00 for XL - 2XL, Add \$5.00 3XL - 5XL

WB-07: Navy Blue WB-11: Fluorescent Orange WB-01: Black

Add the SECURITY IDs to the above PLAIN WINDBREAKER for only \$7.00

Also available in Red, Yellow, Green and Orange. Call for details!



\$9⁹⁵

FULL-LENGTH RAINCOATS 100% PVC

- Durable raincoat with removable snap-on drawstring hood
- Weather resistant back-flap
- Netted lining for warmth & durability
- Front storm flaps with 4 snap-on buttons
- Adjustable wristband snaps
- Wide side pockets
- Block lettering (3") back
- Block lettering (1½") front

WITH SECURITY ID

\$7⁹⁵

Add \$2.00 for XL - 2XL, Add \$5.00 3XL - 4XL

JS-40: Raincoat with Security ID

WITH POLICE ID

\$7⁹⁵

JS-41: Raincoat with Police ID

RAINCOAT WITH NO ID

\$7⁹⁵

Add \$2.00 for XL - 2XL, Add \$5.00 3XL - 4XL

JS-42: Raincoat without ID (Plain)

All raincoats are available in sizes:

- Small • Medium • Large • 1XL • 2XL • 3XL • 4XL



PROFESSIONAL BLAZERS

- Sturdy 100% polyester
- Selective single-breasted blazers ensure a professional appearance
- Elegantly trimmed with gold buttons featured on front and sleeves

- Reinforced, comfortable lining and stitching throughout
- Form-fitting with ¼" edge stitching
- Smooth back with center vent
- Two lower patch pockets with flaps
- Left breast welt pocket



\$25⁹⁵ **BL-01: Burgundy**



\$25⁹⁵ **BL-07: Black**



\$25⁹⁵ **BL-03: Navy Blue**

Available in chest sizes with regular lengths:

- Small (32-34)
- Medium (36 - 38)
- Large (40 - 42)
- 1XL (44 - 46)
- 2XL (48 - 50)
- 3XL (52 - 54)
- 4XL (56-58)

For all blazers add \$3.00 for XL-3XL and \$5.00 for 4XL

PROFESSIONAL UNIFORM SLACKS



- Twill weave with unique blended stitches for a seamless appearance
- 100% texturized Dacron polyester
- Grab & hold waistband liner designed to keep shirts snug
- Roomy side pockets: 9" pocket depth 6" pocket width darts for a better fit
- Smooth button closure
- Reinforced bar tacking on pockets, belt-loops, & zipper
- Fortified belt-loops
- Buttoned through back pockets
- Full interlining waistband
- Available in sizes: 28 - 60" waist

\$12⁹⁵

P-17: Heather Grey

Add \$3.00 for 42-50"; \$5.00 for 52-60"

Unhemmed. Tailoring available at \$3.95 per pair. See page 128

DOUBLE BREASTED DRESS COAT

Naval Officer Blue, fully lined, 6-button, double breasted style dress coat is made of a 11½-12 ounce 55/45 Polyester/Wool, gabardine dress weave.

More form-fitting than our usual dress coat styles. Includes peak lapels, light quilting in the upper chest lining, two lower welt pockets, an upper welt simulated breast pocket, and three cloth-reinforced inside pockets. An optional badge tab may be added..

Polyester/Wool Dress Coat: FCN-8696C
Available in even sizes: 36 - 50 (Regular)

\$249⁹⁵

Matching Polyester/Wool Dress Pants: FCP-8696
Unhemmed: 36½"

Available in sizes: 30" - 38" (odd & even sizes)
40" - 50" (even sizes only)

Add \$9.00 for sizes 44" - 50"

\$79⁹⁵

See page 44 for dress shoes



ELASTIQUE WEAVE UNIFORM SLACKS

7 POCKET UNIFORM TROUSERS 100% TEXTURIZED DACRON POLYESTER

- Front pleats and back darts for form-fitting comfort
- Front closure features brass zipper, crush proof clasp, & curtain button
- Belt loops withstand heavy belts, will fit 2¼" belt
- Bartacking at stress points
- Deep front slash pockets



- Coin pocket near waistband
- 2 back pockets with left pocket button closure
- Additional SAP pockets for flashlights & other lightweight accessories
- Interlined waistband designed to keep shirts in place once tucked

\$12⁹⁵

Available in even waist sizes:
28 - 60" waist
Add \$3.00 for 42-50;
\$5.00 for 52-60

← Elastique weave fabric

Slacks with sap pockets available in these colors:



P-04: Black

P-02: Dark Grey

P-10: Brown

P-06: Navy Blue

P-08: Spruce Green

Need a pant stripe to match your shirt? No problem!
Choose from our suggested colors for only \$6.95 per pair.
In-stock Stripe Colors: Available in 1" only

| Stripe Color | Navy Blue | Black | White | Light Cyan | Gold | Tan | Red | Light Grey | Dark Grey | Silver |
|--------------|------------------|--------------|--------------|-------------------|-------------|------------|------------|-------------------|------------------|---------------|
| Codes | ST-01 | ST-03 | ST-05 | ST-07 | ST-20 | ST-09 | ST-11 | ST-15 | ST-17 | ST-21 |

READY TO SHIP PRE-STRIPED SLACKS

SP-12
Light Blue
on Black



\$14⁹⁵

Available in sizes:
28 - 60" waist
comes with 1" striping
Add \$3.00 for 42-50;
\$5.00 for 52-60



100% POLYESTER TWILL WEAVE SLACKS



**100% POLYESTER
EXCELLENT FOR SECURITY GUARDS & POLICE**

- Back darts in back for form-fitting comfort
- Front closure features brass zipper, crush proof clasp, & curtain button
- Belt loops withstand heavy belts, will fit 2 1/4" belt
- Bartacking at stress points
- Deep front slash pockets
- Coin or watch pocket near waistband
- 2 back pockets with left pocket button closure
- Interlined waistband designed to keep shirts in place



~~Retail Price \$19.95~~

\$11.95

P-26: Navy blue P-24: Black
With Sap Pockets

All sizes same price

\$9.95

~~Retail Price \$17.95~~

CHP-01: Navy blue CHP-02: Black
With out Sap Pockets

Available in even waist sizes
ALL SIZES SAME PRICE

Unhemmed. Tailoring available

BDU DUTY SHORTS



Tough construction for tactical maneuvers:

- Based on same design as our BDU pants
- 65% polyester & 35% cotton
- Quick drying fabric
- Reinforced seat
- Double-stitched seams
- Machine washable
- 6 Pockets: 2 front slash pockets, 2 rear pockets and 2 over sized cargo pockets
- Button closures on rear and cargo pockets
- Adjustable waist straps
- Button fly
- 21" in length

Available sizes:
Small (27-31)
Medium (32-35)
Large (35-39)
XL (39-42)
2XL (43-46)
3XL (48-50)
4XL (52-54)

Add \$3.00 for 2XL-3XL;
\$5.00 for 4XL

\$19.95

BPS-10: Black

BPS-12: Navy Blue

BPS-14: Green

UNIFORM KHAKI SLACKS



- 63/35 Polycotton slacks hold a crisp uniform look
- 4 Heavy duty pockets: 2 slant pockets, 2 back hip pockets with left pocket button closure
- Fitted for comfort
- Brass zipper reinforced by snap button for security closure
- All stress points have bartack reinforcements

Available in even waist sizes:
28 - 50" waist
Add \$3.00 for 42-50

P-20: Khaki **\$9.95**

Unhemmed. Tailoring available
at \$3.95 per pair.

DUTY SHORTS

- 2 front and back button-down cargo pockets
- Deep 10" front slash pockets
- Reinforced stitching at stress points for added strength
- Vented hems on cuffs for a relaxed fit
- Additional cotton lining along waistband for comfort and strength
- 19" in length

Available sizes:
Waist: 28 - 60"
even sizes only

Add
\$3.00 for 42-50
\$5.00 for 52-60



\$14.95

PS-33: Black PS-31: Navy blue
See duty gear section for belts.

DURABLE EMS PANTS

SAME DURABILITY FOUND IN HIGHER PRICED NAME BRAND APPAREL

- Polycotton
- Reinforced bar tacks at all stress points
- Front zip and hook closure
- 2 front pockets with flaps
- 2 back pockets with flaps and Velcro
- 2 cargo pockets with flaps
- Right cargo pocket has 3 slotted patches and 2 straps with snaps
- Unhemmed



EMS-01: Navy blue

EMS-04: Black

\$19⁹⁵

Available sizes:
Waist: 28 - 60"
even sizes only

Add
\$5.00 for 42-50
\$7.00 for 52-60

TACTICAL BDU PANTS

Tough construction:

- 65% polyester & 35% cotton
- Quick drying fabric
- Reinforced seat and knee areas
- Double-stitched seams
- Machine washable
- 6 Pockets: 2 front slash pockets, 2 rear pockets & 2 over-sized cargo pockets
- Button closures on rear and cargo pockets
- Adjustable waist straps
- Adjustable draw string bottoms
- Button fly



BP-10: Black

BP-12: Navy Blue



BP-14: Green

\$14⁹⁵

Available sizes:
Small (27-31)
Medium (32-35)
Large (35-39)
XL (39-42)
2XL (43-46)
3XL (48-50)
4XL (52-54)
5XL (56-60)

Add
\$3.00 for 2XL-3XL;
\$5.00 for 4XL-5XL

POLYCOTTON UNIFORM SHIRT



SC-08: Half-sleeve shirt
Light Blue Only

Available in sizes
Small - 5XL

Add
\$5.00 for XL - 5XL

\$9⁹⁵

EMT WHITE SHIRT



Pencil slot in left
flapped pocket

Available in sizes
Small - 5XL

\$9⁹⁵

EMT-01: Half-sleeve shirt
White Only

Add
\$5.00 for XL - 5XL

LAPD CERTIFIED UNIFORM TROUSERS BY ELBECO

100% Worsted Wool

- Straight front pockets
- Watch pocket
- 2 back hip pockets
- 2 back billy pockets
- Reinforced 3/4" inserted belt loops
- Seat completely lined
- Sung-tex waistband to keep shirts neatly tucked-in
- Additional support provided by French fly
- Bartacking at stress points
- Dry clean only

WAS
~~\$64⁹⁵~~
 NOW
\$69⁹⁵



Available for both men & women:
 Men's even sizes 28"-58"
 Women's even sizes 8-24

Add:
 \$6.00 for sizes 44-50
 \$10.00 for sizes 52-54
 \$15 for sizes 56, 58

Now save an additional 10% off these LAPD and Sheriff Pants.

FREE hemming on LAPD pants.
 No exchanges or refunds on tailored items.

NBL-03: Men's Navy Blue 100% wool
NBL-04: Women's Navy Blue 100% wool

LA COUNTY CERTIFIED SHERIFF PANTS

Polyester & Worsted Wool

- Straight front pockets
- Watch pocket
- 2 back hip pockets
- 2 back billy pockets
- Reinforced 3/4" inserted belt loops
- Seat completely lined
- Sung-tex waistband to keep shirts neatly tucked-in
- Additional support provided by French fly
- Bartacking at stress points
- Dry clean only

WAS
~~\$69⁹⁵~~
 NOW
\$69⁹⁵

Available in even sizes: 28"-58"

Add:
 \$6.00 for sizes 44-50
 \$10.00 for sizes 52-54
 \$15 for sizes 56, 58



SGP-01: Sheriff's Green

FREE hemming on LA Sheriff pants.
 No exchanges or refunds on tailored items.

FRONTLINE MOTOR BREECHES



We accept purchase orders from government institutions, large corporations, and universities upon credit approval.

FEATURES

- 2 inch waistband
- Snug-Tex with ban roll waistband & tunnel belt loops
- Deep front top pockets
- Rear back welt pockets and Billy pockets
- Heavy weight pocket fabric
- Triangle bar tacks
- Reinforced rounded seat
- Zippered leg
- Double knee
- Inside knee dart
- Pressed open leg seams
- Dry Clean Only

\$99⁹⁵ **FABRIC: POLYESTER** - (in stock for quick shipping)
 • 12.5-13 oz. Polyester Elastic Weave
FMP-01 Dark Navy

\$134⁹⁵ **FABRIC: DAC/WOOL** - (in stock for quick shipping)
 • 16.5 oz. Elastic Weave 55% Polyester 45% Worsted Wool
FMD-02 Silver-Tan FMD-01 Dark Navy FMD-03 Heather Green

\$149⁹⁵ **FABRIC: 100% WORSTED WOOL**
 • 19.5-20 oz. Elastic Weave 100% Worsted Wool
FMW-02 Silver-Tan FMW-01 Dark Navy

SIZE CHART

| | | Waist | 30 | 32 | 34 | 36 | 38 | 40 | 42 | 44 |
|--------|-------------|------------------------------|------------------------------|----|----|----|----|----|----|----|
| Inseam | Short (25") | NA | Available upon request only. | | | | | | | |
| | Reg (27") | ✓ | ✓ | ✓ | ✓ | ✓ | ✓ | ✓ | ✓ | ✓ |
| | Long (29") | Available upon request only. | | | | | | | | |

Add \$9.00 for sizes 42-44

CLIP-ON & BREAK AWAY TIES

Distinctive stripes allow personnel to wear with various colored shirts. Navy blue striped ties feature thin red, burgundy, & white stripes. Burgundy striped ties feature thin navy blue, gray-blue, & white stripes.



| Color | Black | Navy Blue | Brown | Burgundy with stripes | Navy Blue with stripes | Royal Blue |
|--------------|-------|-----------|-------|-----------------------|------------------------|------------|
| Clip-on Ties | CT-01 | CT-03 | CT-05 | CT-07 | CT-09 | CT-14 |
| Break Away | CT-11 | CT-12 | CT-13 | NA | NA | NA |
| Cross Ties | CT-02 | CT-04 | CT-06 | CT-08 | CT-10 | NA |

65/35 POLY-RAYON DRESS SUIT



For a professional appearance, the 65/35 Poly-Rayon Dress Suit fits the bill. Providing both comfort and style, this suit coat is fully lined, and includes an upper welt insulated pocket, 2 front flap pockets and 3 inside pockets (including pen compartment).

The form fitting dress coat features side vents and 4 buttons on sleeve.

Pants have a single pleat, with a 1 1/2" waistband and 36" unhemmed length.

DS-01: Black

DS-02: Navy Blue

\$79.95



Available in chest sizes with regular lengths:

Black: 36" - 52" waist

Navy Blue: 36" - 54" waist

The set comes with pant waist sizes that are 6" smaller than the chest size.

Add \$10.00 for waist sizes 44" - 54"

Short and long sizes available on special request.

Tel: (877) 643-1100 ---- Toll Free
Fax: (877) 700-4477 ---- Toll Free

(818) 341-1500 (US & NON US calls) PST
(818) 341-0015 (US & NON US calls) PST

Phone Ordering
 M-F 7am - 5:30pm
 Sat 9am - 2pm

ALL WEATHER DELUXE TROPICAL SHIRTS



Our All Weather Deluxe Tropical weave shirts are comfortable and durable. They are made from 10-10½ ounce, 65/35 Poly/Rayon. These shirts are often imitated but never duplicated. The 6600 series is a sturdy yet “breathable” fabric that retains its body and drape. Wearers attest these Deluxe Tropicals become more comfortable after each machine washing! Available in many colors and styles, it’s the choice of many agencies nationwide.

Standard shirt features include:

- Form-fitted tailored look designed to fit comfortably over body armor
- Pleated pockets with scalloped flaps and Velcro’ closures
- 5 permanent sewn in creases, two in the front continuing through pocket and flap, and three in the back
- 7-button placket front
- Durable, double-stitched shoulder straps and pocket flaps
- Hidden pencil compartment
- Full badge sling
- Optional concealed zipper may be added

\$45⁹⁵

\$49⁹⁵

Short sleeve:

Available in sizes: Small - 5XL
Add \$9.00 for sizes 3XL - 5XL

Long sleeve:

Available in neck sizes: 14½” - 18½” - 21½”
Add \$9.00 for neck sizes: 19½” - 21½”

Standard Shirt Colors

| | Short sleeve | Long sleeve |
|----------------------------|--------------|-------------|
| LAPD BLUE | FCS-6686 | FCL-6686 |
| Medium Blue | FCS-6625 | FCL-6625 |
| White | FCS-6600 | FCL-6600 |
| Border Patrol Green | FCS-6687 | NA |
| French Blue | FCS-6626 | FCL-6626 |
| Black | FCS-6610 | FCL-6610 |
| Nickel Grey | FCS-6651 | FCL-6651 |
| Silver Tan | FCS-6604 | FCL-6604 |



65/35 POLYESTER/COTTON DURO POPLIN SHIRTS

The 5400 series of 65/35 Poly/Cotton, machine washable, Permanent Press material remains a popular choice for those who appreciate the benefits of Cotton and the durability of Polyester. It’s available in a variety of styles and colors.

Standard Shirt Features Include:

- Form-fitted tailored look designed to fit comfortably over body armor
- Pleated pockets with scalloped flaps & Velcro’ closures
- 5 permanent sewn in creases, two in the front continuing through pocket and flap, and three in the back
- 7-button placket front
- Durable, double-stitched shoulder straps and pocket flaps
- Hidden pencil compartment
- Full badge sling
- Optional concealed zipper may be added

Short sleeve: \$27⁹⁵

Available in neck sizes: 14½” - 18½” - 21½”
Add \$6.00 for 19½” - 21½”

Long sleeve: \$29⁹⁵

Available in neck sizes: 14½” - 18½”
Add \$6.00 for 19½” - 21½”

| Available Colors | White | Navy Blue | M. Blue |
|------------------|----------|-----------|----------|
| Short Sleeve | FCS-5400 | FCS-5456 | FCS-5435 |
| Long Sleeve | FCL-5400 | NA | FCL-5435 |

Standard shirt colors



100% WOOL SHIRTS & TROUSERS



These 100% Wool, LAPD Navy, 9586 range shirts and matching trousers offer the ultimate in styling, comfort, and durability. The all wool fabric offers inherent natural breathability and, as a result, is the incomparable California-styled favorite. Shirts are made in a 10-10½ ounce tropical weave, tailored with double needle stitching throughout, and include elbow reinforcement patches. Sewn buttons on shoulder straps and pockets are convertible to accommodate removable metal buttons.

Shirt also features:

- Form-fitted tailored look designed to fit comfortably over body armor
- High luster collar & yoke trim
- 7-button placket front
- Metal eyelet badge holder
- Plain pockets with scalloped flaps & Velcro® closure
- Cross-stitched shoulder straps
- Hidden pencil compartment
- An optional concealed zipper may be added

The trousers are made of durable, 2-ply, 17-17½, ounce, 100% Wool, and feature hip, and club pockets, plus a fully lined seat. Unhemmed.

SHIRTS: Men's

Short sleeve: FCS-9586

Available in neck sizes: 14½" - 21"
Add \$12.00 for 19", 20", 21"

\$49⁹⁵

Long sleeve: FCL-9586

Available in neck sizes: 14½" - 21"
Add \$15.00 for 19", 20", 21"

\$59⁹⁵

SHIRTS: Women's

Short sleeve: FCS-9586W

Available in bust sizes: 32" - 44"

\$49⁹⁵

Long sleeve: FCL-9586W

Available in neck sizes: 32" - 44"

\$59⁹⁵

TROUSERS

FCP-32289

Available in even sizes: 32" - 50"
Add \$10.00 for 44" - 50"

\$64⁹⁵



65/35 POLYESTER/COTTON RESPONSE WEAR

SHIRTS

- Available in Navy Blue
- Left breast pocket has imitation flap with convenient opening at top, and separate pencil compartment.
- Tailored generously for comfortable fit
- 5 permanent sewn in creases, two in the front continuing through pocket and flap, and three in the back
- 7-button placket front with concealed buttons
- Neck sizes: 14½" - 18½"

Short sleeve: FCS-5286

Add \$9.00 for 19", 20", 21"

\$27⁹⁵

Long sleeve: FCL-5286

Add \$9.00 for 3XL - 5XL

\$39⁹⁵

TROUSERS

- Available in Navy Blue.
- Reinforced hook & eye closure with fully functional French-Fly tab
- Brass metal memory lock zipper for longer life
- Deep pockets preventing items from falling out
- Lined belt loops for improved appearance & added durability
- All pockets and stress points securely bartacked for added strength
- Extra fabric at waist allows for let out
- Waist sizes: 32" - 50"
- Trousers unhemmed (36½")

FCP-4954

Add \$9.00 for 44" - 50"

\$29⁹⁵

FLYING CROSS/FECHEIMER CHP MEN'S UNIFORMS

CHP certified uniforms for the California Highway Patrol. Premium uniform shirts and pants made with exact specifications. Available in wool blend and rayon tropical blend.



CHP MEN'S SHIRTS



- Plain pockets with scalloped flaps
- Cross-stitched shoulder straps and no military creases
- Elbow patch reinforcement on long sleeves
- 1/4" Double needle stitching throughout and metal eyelet badge holder

FCL-6504

\$49⁹⁵

CHP MEN'S LONG SLEEVE SHIRT SILVER TAN

9½ - 10 oz. 65/35 Polyester/Rayon, Tropical.

Available in neck sizes: 14½" - 20"; Add \$9.00 for 19" - 20"



FCS-9404

\$45⁹⁵

CHP MEN'S SHORT SLEEVE SHIRT SILVER TAN

9½ - 10 oz. 65/35 Polyester/Rayon, Tropical

Features a convertible sport collar with permanent collar stays.

Available in sizes: Small - 5XL; Add \$9.00 for 3XL - 5XL

FCS-6504

\$69⁹⁵

CHP MEN'S SHORT SLEEVE SHIRT SILVER TAN

11½ - 12 oz. 2-ply 55% Polyester / 45% Wool

Features a convertible sport collar with permanent collar stays.

Available in sizes: Small - 5XL; Add \$9.00 for 3XL - 5XL



FCP-CHP

\$129⁹⁵

CHP MEN'S TROUSERS WITH BRAID

100% Wool, Elastique

Features half top pockets, 2" tunnel belt loops, club pockets, and watch pocket.

CHP braid sewn over side seam.

Unhemmed.

Available in odd and even sizes: 32" - 46"

Add \$10.00 for sizes 42" - 46" (even sizes only)

FLYING CROSS/FECHEIMER SHERIFF SHIRTS

LA sheriff shirts certified for the Los Angeles County Sheriffs Department. Premium uniform shirt made with exact specifications.

SHERIFF'S CLASS B SHORT SLEEVE TAN SHIRT

65% Polyester / 35% Cotton Poplin

Features:

- Plain front pockets with pen compartment in left pocket
- Metal badge eyelet holder
- Fully lined placket fronts
- Convertible sports collar with permanent collar stays

Available in neck sizes: 14½" - 18½", 20" - 21"

FCS-5603

\$19⁹⁵

Add \$10.00 for neck sizes 20" - 21"



PORTABLE GUARD BOOTH

• Durable construction with a 20+ year life • Outside Dimensions: 5'W x 6'L x 8'H • Anodized aluminum finish is resistant to rusting or surface deterioration • Insulated double walls • Structural steel framework, from door to ceiling • Sliding windows on three sides allow greater flexibility • 1-3/4" thick anodized swing door with lock provides additional security • 34" window sill height makes transactions fast and convenient • Includes work table, 2 external lighting and 1 internal lighting fixture • Option of electrical outlet for appliances (Electrical wiring required)



\$1,999⁹⁵

SB-01

+ Shipping and Handling Charges



Perfect for:

- Security/Guard personal
- Parking Booth
- Cashier Booth
- Guard Booth
- Ticket Booth
- Perimeter Security
- Car wash attendant Booth

This durable and convenient portable booth comes pre-assembled.
Please call 1-877-643-1100 (8am-5pm PST Mon-Fri) for shipping cost to your location.



RYNO GEAR FOOTWEAR

DUTY BOOTS AT AN UNBEATABLE PRICE

8" STRIDER BOOTS

- Water resistant leather and durable nylon construction
- 8" ankle height with padded nylon tongue
- Slip-resistant rubber outsole



\$24⁹⁵

RY-03

Sizes: 6-13 (full sizes only)



6" STRIDER BOOTS

Value-priced boots modeled for durability and speed

- Water resistant leather and durable nylon construction
- 6" ankle height with padded tongue
- Slip-resistant rubber outsole



\$23⁹⁵

RY-04

Sizes: 6-13 (full sizes only)

OXFORD DRESS SHOES

For a professional appearance, our dress Oxford shoes fit the bill. They have a high gloss upper that is perfect for formal wear.

- High gloss upper never needs to be shined
- Cushioned lining keeps your feet comfortable
- Slip-resistant polyurethane sole



\$19⁹⁵

SH-03

Sizes: 6-13 (full sizes only)



ALL LEATHER 8" DUTY BOOTS

Designed to keep you dry in the most extreme weather. Inner lining withstands up to 6" water levels.

- 100% full-grain leather
- 8" ankle height with padded nylon tongue
- Slip-resistant rubber outsole

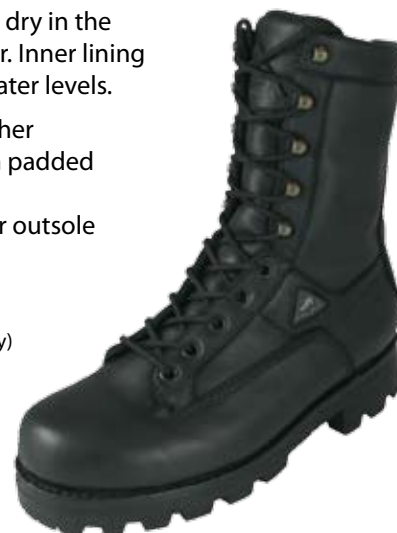

\$49⁹⁵

RY-05

Sizes: 6-13 (full sizes only)

\$49⁹⁵

RY-06

a steel toe version
Sizes: 6-13 (full sizes only)

6" & 8" TACTICAL PRO ZIPPER BOOTS

- Water resistant leather and durable nylon upper
- Slip-resistant rubber outsole
- Side zipper for easy on/off
- 6" or 8" ankle height with padded nylon tongue



6" High:

RY-12 (with regular toe)

\$39⁹⁵

Sizes: 6-13 (full sizes only)



8" High:

RY-10 (with steel toe)

RY-11 (with regular toe)

\$39⁹⁵

Sizes: 6-13 (full sizes only)



RYNO GEAR FOOTWEAR

DUTY BOOTS AT AN UNBEATABLE PRICE

8" TACTICAL ZIPPER BOOTS

- Full-grain leather
- 8" ankle height with padded nylon tongue
- Slip-resistant rubber outsole
- Side zipper for easy on/off



\$29⁹⁵

RY-01
 Sizes: 6-13
 (full sizes only)

6" TACTICAL BOOTS

- Full-grain leather
- 6" ankle height with padded nylon tongue
- Slip-resistant rubber outsole



\$29⁹⁵

RY-02
 Sizes: 6-13
 Full sizes only

DANNER ARCADIA 8" TACTICAL BOOTS

- Ideal for action in warmer climates
- Water-resistant Leather
- Smart, easy to wear boot (U.S.M.C approved)
- 1000 denier Cordura & a Gore-tex liner to deliver all round performance
- Rugged, Durable Vibram Kletterlift outsole



\$229⁹⁵

Men's Regular RY-15
 Sizes: 7-13 (available in 1/2 sizes)

Men's Wide RY-16
 Sizes: 9-12 (wide full sizes only)

Women's Boots RY-17
 Women's Sizes: 7-19
 (available in 1/2 sizes)

LEATHER GLOVES

- Cut resistant
- Lined for maximum warmth
- Available in S thru 3XL



\$14⁹⁵ 1 pair
GL-01
 Size: S - 3XL

See page 131 for glove size chart.

SOCKS

The soft bottom cushion your feet reducing fatigue and adding to your comfort.



4 pairs for only
\$9⁹⁵

SO-01:
Men's Quarter

FOLDING KNIVES



- Made of #420 steel
- Blade Surface: Camouflage
- Includes nylon case
- Open length: 5½"
- Closed length: 4¾"

KN-01 \$9.95

- Made of #420 steel
- Blade Surface: Black satin
- Includes nylon case
- Open length: 6¾"
- Closed length: 4¾"

KN-02 \$9.95



- Made of #420 steel
- Blade Surface: Black satin
- Includes nylon case
- Open length: 8"
- Closed length: 4½"

KN-03 \$9.95



You must check your own state for laws and regulations on the use of knives.



- Made of #420 steel
- Blade Surface: Polished
- Includes nylon case
- Open length: 6¾"

• Closed length: 4"

KN-04 \$9.95



- Made of #420 steel
- Blade Surface: Black satin
- Includes nylon case
- Open length: 7¾"

• Closed length: 4½"

KN-05 \$9.95



KN-06 \$9.95

- Made of #420 steel
- Blade Surface: Polished
- Includes nylon case

• Open length: 7¼"
• Closed length: 4¼"



White Shell KN-07

\$9.95

Wood grain KN-09



- Made of #420 steel
- Blade Surface: Black satin
- Includes nylon case
- Open length: 7¾"

• Closed length: 4½"

KN-08 \$9.95

- Made of #420 steel
- Blade Surface: Flat Black Textured
- Includes nylon case

- Open length: 7¾"
- Closed length: 4½"
- Mini Flashlight

CAPS

Call for ADDITIONAL colors

HT-29: Black with white Sheriff*

HT-19: Black with white Police*

*Police and Sheriff caps require proof of occupation at time of order

- Raised embroidery
- Back Velcro adjustment
- 6 paneled structure cap
- Reinforced stitching includes 6 sewn eyelets

Customize your caps with a custom or stock emblem see pages 74-81



HT-13: Plain Black Cap \$3.95
HT-03: Plain Navy Blue Cap



\$4.95

\$7.95

HT-31: Black with EMT Patch



HT-34: Navy Blue with White Fire Dept
HT-33: Black with White Fire Dept

HT-30: Navy Blue with White EMT
HT-32: Black with White EMT

HT-06: Navy Blue with Gold Security
HT-16: Black with Gold Security

HT-05: Navy Blue with White Security
HT-15: Black with White Security

MASKS AND BEENIES

• One-size fits all • Shape retention • Raised embroidery

Call for ADDITIONAL colors \$3.95 each minimum 1 dozen

\$3.95

Ski Mask stretches



\$4.95



\$3.95



\$4.95



\$4.95



\$4.95



HT-07: Plain Black Ski Mask
HT-09: Black Ski Mask with White Security

HT-10: Plain Black Beanie
HT-11: Black Beanie with White Security

HT-21: Black Beanie with White Sheriff
HT-20: Black Beanie with White Police

Tel: (877) 643-1100 ---- Toll Free
Fax: (877) 700-4477 ---- Toll Free

(818) 341-1500 (US & NON US calls) PST
(818) 341-0015 (US & NON US calls) PST

Phone Ordering M-F 7am - 5:30pm Sat 9am - 2pm

CAMPAIGN HAT

Summer hats made from genuine straw • Cool Comfortable • Lightweight

\$19⁹⁵

HT-100: Black



SIZES: SML 6⁵/₈-6³/₄
 M 7¹/₈-7¹/₄
 XLRG 7¹/₂-7⁵/₈

\$19⁹⁵

HT-101: Dark Grey



Hat Ropes (sold separately)
 HR-00: Black & Gold HR-01: Silver

\$4⁹⁵

CUSHION AIR SERVICE CAPS

8 Point Service Hat with Combo Band

- Polyester construction
- Navy material
- Eyelet vent holes keeps you cool



Sizes: Sml6¹/₂ - 6³/₄
 Med6⁷/₈ - 7¹/₈
 Lrg7¹/₄ - 7³/₈
 XLrg7¹/₂ - 7⁵/₈

\$24⁹⁵
 HT-102



Round top Service Hat

- Polyester construction
- Navy material
- Eyelet vent holes keeps you cool



Sizes: Sml6¹/₂ - 6³/₄
 Med6⁷/₈ - 7¹/₈
 Lrg7¹/₄ - 7³/₈
 XLrg7¹/₂ - 7⁵/₈

\$29⁹⁵ HT-103

HOW TO: PROPER INSERTION OF SOFT EARPLUGS

Protecting your hearing should be of prime importance to us all. Wearing ear protection at the range or at any time loud noise are present should be mandatory.

Inserting earplugs is just as important as which type to use for your purpose.

All types of foam earplugs, whether they're pillow-shaped or tapered should be inserted the same way.

First shape the earplug to your ear canal opening by rolling one end between your fingers. Next, pull your ear away from your head. This causes the ear canal to straighten for easier insertion.

Be careful how far you insert them into your ear canal. At least half of the earplug should be left outside the canal. This way you'll be able to grasp it for easy removal.

First compress one end by rolling it between your fingers.

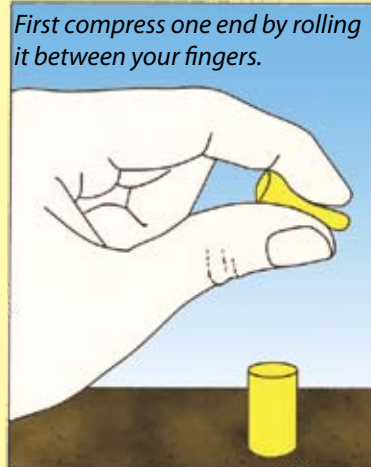

Pull ear lobe upward to open ear canal then insert the plug.



FACTORY DIRECT SYNTHETIC LEATHER GEAR

SYNTHETIC LEATHER GEAR BELT COMBO



30% LIGHTER THAN LEATHER GEAR!

Adjustable two sizes up or down

Available in even sizes: 30" - 60"
 Sizes 44-48, add \$2.00 Sizes 50-60 add \$4.00

\$59⁹⁵ SLC-01

- Duty-belt and belt buckle
- Xenon Flashlight w/ 2 batteries
- Flashlight Ring Holder
- Set of 4 Keepers
- Stainless Steel Handcuffs
- Handcuff Holder
- MK3 Pepper Spray
- Pepper Spray Holder

SYNTHETIC LEATHER GEAR ACCESSORIES

2 1/4" Duty Belt



SL-01
\$9⁹⁵

Adjustable two sizes up or down
 Available in even sizes: 30" - 60"
 Sizes 44-48, add \$2.00 Sizes 50-60 add \$4.00

Single Handcuff Holder



SL-03
 Hidden snap
\$8⁹⁵

Double Handcuff Holder



SL-04
 Hidden snap
\$9⁹⁵

Large Pepper Spray Holder



SL-07
 Hidden snap
\$9⁹⁵

Small Pepper Spray Holder



SL-05
 Hidden snap
\$9⁹⁵

Set of 4 Keepers



Hidden snap: SL-17
 Nickel snap: SL-18
\$6⁹⁵

Grip Flashlight Holder



SL-21
\$5⁹⁵

30% LIGHTER THAN LEATHER GEAR!

Ring Flashlight Holder

\$3⁹⁵



Black snap: SL-19
 Nickel snap: SL-27

FACTORY DIRECT SYNTHETIC LEATHER GEAR

SYNTHETIC LEATHER GEAR ACCESSORIES

Expandable Baton Holder



SL-10
\$9⁹⁵

Ring baton holder



Black snaps: SL-13
Nickel snaps: SL-14
\$3⁹⁵

Double Magazine Holder



SL-23
Hidden snaps
\$9⁹⁵

Double Speed Loader Case



SL-02
Hidden snaps
\$9⁹⁵

Radio Holder



\$9⁹⁵ SL-11
Velcro®

Key Holder



\$3⁹⁵ SL-15
Velcro®

Mini-Flashlight Holder



\$9⁹⁵ SL-22
Velcro®

Mini-Flashlight Holder



SL-20
\$5⁹⁵

Glove Holder



Velcro®: SL-30
Nickel snap: SL-31
\$9⁹⁵

Gun Holster

Made to fit the following frames:

- 4 or 6 inch revolver
- 357 magnum
- 38 revolver
- 44 magnum
- 45 long colt



\$29⁹⁵

HL-10

UPGRADE TO SYNTHETIC LEATHER!

**LOOKS LIKE LEATHER!
30% LIGHTER!**

**BADGE HOLDER
BASKET WEAVE LEATHER
WITH CHAIN
AND CLIP BACK**



L-18
\$9⁹⁵

BASKET-WEAVE LEATHER GEAR

DUTY BELT COMBO



Top Grain Leather

\$59⁹⁵

CB-01

Adjustable two sizes up or down
 Available in even sizes: 30" - 60"
 Sizes 44-48, add \$2.00 Sizes 50-60 add \$4.00

- Duty-belt and belt buckle
- 3-D Cell Flashlight
- Flashlight Ring Holder
- Set of 4 Keepers
- Stainless Steel Handcuffs
- Handcuff Holder
- MK-3 Pepper Spray
- Pepper Spray Holder

BASKET-WEAVE LEATHER ACCESSORIES

Collapsible Baton Holder



L-12
\$9⁹⁵

Easy access baton Holder



L-25
\$9⁹⁵

Quickly snaps open

For left and right handed

Collapsible Baton Holder



L-13
\$3⁹⁵

Expandable Baton Holder



L-10
\$7⁹⁵

Small Pepper Spray Holder



L-05
\$5⁹⁵

Large Pepper Spray Holder



L-07
\$7⁹⁵

Radio holder with Velcro strap



L-11
\$7⁹⁵

Plain leather open handcuff holder



PL-04
\$7⁹⁵

Handcuff holder



\$6⁹⁵

Round badge holder with clip*



L-08
\$9⁹⁵

Fits star and round badges

Oval badge holder with clip back*



L-06
\$9⁹⁵

Fits standard and Federal size badges

Plain leather ID holder



\$9⁹⁵

- Police/Security
- Event management
- Media pass
- VIP pass - Event Pass
- Luggage Tags

ID-01

*Badges not included. See pages 62-72

We accept purchase orders from government institutions, corporations, universities and other companies upon credit approval.

Tel: (877) 643-1100 ---- Toll Free
 Fax: (877) 700-4477 ---- Toll Free

(818) 341-1500 (US & NON US calls) PST
 (818) 341-0015 (US & NON US calls) PST

Phone Ordering
 M-F 7am - 5:30pm
 Sat 9am - 2pm

BASKET-WEAVE LEATHER GEAR

We accept purchase orders from government institutions, corporations, universities and other companies upon credit approval.

2 1/4" DUTY BELT



WAS ~~\$14.95~~
\$12.95

L-01

Available in sizes: 30" - 60"

Available in even sizes 44-48, add \$4.00, even sizes 50-60 add \$5.00

1 1/2" TROUSER BELT



WAS ~~\$8.95~~
\$6.95

L-09

1 3/4" TROUSER BELT



WAS ~~\$8.95~~
\$7.95

L-31

Available in even sizes: 28" - 60"

For sizes 44-48 add \$2.00 for sizes 50-60 add \$3.00

1 1/2" DUO-BELT



\$9.95

L-39

No buckle
Velcro closure

BASKET-WEAVE LEATHER ACCESSORIES

Double magazine Holder



L-23
\$9.95

Double Speed loader case holder



L-02
\$9.95

Key chain Holder



L-15
\$5.95

Ring flashlight Holder



L-19
\$3.95

Grip flashlight Holder



\$4.95 L-21

Set of 4 keepers



\$3.95 L-17

WHOLESALE BRAND NAME GUN HOLSTERS

Made to fit the following frames:

- 4 or 6 inch revolver
- 357 magnum
- 38 revolver
- 44 magnum
- 45 long colt



\$19.95 HL-10

BRAND NAME BASKET WEAVE GUN HOLSTERS

UAW offers many **TRIPLE K** gun holsters. In order for us to assist you, we will need the make and style of your weapon (revolver or semi-automatic) along with barrel length.

Please call us with this information for the fastest service.

\$29.95



BASKET WEAVE LEATHER ACCESSORIES WITH BRASS FITTINGS

Available in even sizes:
30" - 60"



2 1/4" DUTY BELT

For sizes 44-48 add \$4.00
For sizes 50-60 add \$5.00

\$19⁹⁵ LBR-01



Small Pepper Spray Holder



\$9⁹⁵ LBR-05

Large Pepper Spray Holder



\$9⁹⁵ LBR-07

Set of 4 keepers



\$6⁹⁵ LBR-17

Double magazine holder



\$9⁹⁵ LBR-23

Handcuff holder



\$9⁹⁵ LBR-03

Ring flashlight Holder

\$5⁹⁵



Key chain Holder

\$9⁹⁵



BASKET-WEAVE & BRASS BELT COMBO

\$79⁹⁵
CBR-01



Adjustable two sizes up or down

Available in sizes:
30" - 42", 44" - 48", 50" - 60"
Sizes 44-48, add \$2.00
Sizes 50-60 add \$4.00

- Duty-belt and brass belt buckle
- 3-D Cell Flashlight
- Flashlight Ring Holder with brass snap
- Set of 4 Keepers with brass snaps
- Stainless Steel Handcuffs
- Handcuff Holder with brass snap
- Mk3 Pepper Spray
- Pepper Spray Holder with brass snap

FACTORY DIRECT PLAIN LEATHER GEAR

DUTY BELT COMBO



**EVERYDAY
LOW PRICES**

PL-01 **\$59⁹⁵**

Adjustable two sizes up or down
Available in even sizes: 30" - 42", 44" - 48", 50" - 60"
Sizes 44-48, add \$2.00 Sizes 50-60 add \$4.00

- Duty-belt and belt buckle
- 3-D Cell Flashlight
- Flashlight Ring Holder
- Set of 4 Keepers
- Stainless Steel Handcuffs
- Handcuff Holder
- MK-3 Pepper Spray
- Pepper Spray Holder

PLAIN LEATHER ACCESSORIES

Ring Baton Holder



PL-13
\$5⁹⁵

Expandable Baton Holder



PL-10
\$9⁹⁵

Baton Holder

Fits batons with side Handle (for left and right handed)



PL-25
\$9⁹⁵

Small Pepper Spray Holder



PL-05
\$9⁹⁵

Large Pepper Spray Holder



PL-06
\$9⁹⁵

Radio Holder



PL-11
\$9⁹⁵

Set of 4 Keepers



PL-17
\$5⁹⁵

Key Ring Holder



PL-15
\$6⁹⁵

Double Magazine Holder



PL-07
\$9⁹⁵

Round badge holder with clip*



L-08
\$9⁹⁵

Fits star and round badges

Oval badge holder with clip back*



L-06
\$9⁹⁵

Fits standard and Federal size badges

*Badges not included. See pages 63-71

**EVERYDAY
LOW PRICES**

FACTORY DIRECT PLAIN LEATHER GEAR

DUTY GEAR

PLAIN LEATHER BELTS

2 1/4" Duty-Belt Top Grain leather



\$19⁹⁵ PL-41

Available in even sizes: 28" - 60"
add \$2.00 for 46-50; add \$3.00 for 52-60

1 3/4" Trouser Belt Top Grain Leather



\$8⁹⁵ PL-31

Available in even sizes: 28" - 60"
add \$2.00 for 46-50; add \$3.00 for 52-60

1 1/2" Trouser Belt Top Grain Leather



\$6⁹⁵ PL-21

Available in even sizes: 28" - 60"
add \$2.00 for 46-50; add \$3.00 for 52-60

PLAIN LEATHER ACCESSORIES

Handcuff Holder with Detachable key ring



PL-20
\$9⁹⁵

Handcuff Holder



\$9⁹⁵
PL-03

Open Handcuff Holder



PL-04
\$5⁹⁵

Ring Flashlight Holder



PL-19
\$5⁹⁵

Grip Flashlight Holder



PL-08
\$6⁹⁵



PL-14
\$29⁹⁵

Gun Holsters

- Fits:
- 4" or 6" revolver
 - 357 magnum
 - 38 revolver
 - 44 magnum
 - 45 long colt

Plain leather shield badge and ID holder



ID-02
\$15⁹⁵

Plain leather wallet with Shield badge and ID holder



ID-06
\$18⁹⁵

Plain leather star badge and ID holder



\$15⁹⁵ ID-03

Plain leather wallet with star badge ID holder

\$18⁹⁵ ID-09

Plain leather ID holder



- Police/Security
- Event management
- Media pass
- VIP pass - Event Pass
- Luggage Tags

ID-01
\$7⁹⁵

Tel: (877) 643-1100 ---- Toll Free
Fax: (877) 700-4477 ---- Toll Free

(818) 341-1500 (US & NON US calls) PST
(818) 341-0015 (US & NON US calls) PST

Phone Ordering
M-F 7am - 5:30pm
Sat 9am - 2pm



FACTORY DIRECT NYLON GEAR



NYLON DUTY BELT COMBO



CP-01

~~\$49.95~~
\$49⁹⁵

- Duty-belt and belt buckle
- 3-D Cell Flashlight
- Flashlight Ring Holder
- Set of 4 Keepers
- Stainless Steel Handcuffs
- Handcuff Holder
- MK-3 Pepper Spray
- Pepper Spray Holder

For: S (28-32), M (34-36), L (38-40), add \$2:00 for 1XL (42-46) & 2XL (48-52), add \$3:00 for 3XL (54-56) & 4XL (58-60)

RESILIENT & WATER RESISTANT NYLON BELTS

2 1/4" DUTY-BELT WITH CLASP



Available in even sizes 28"-60"

~~WAS \$8.95~~
\$7⁹⁵

N-02

add \$3.00 for 46-50;
add \$5.00 for 52-60

1 1/2" VELCRO DUO-BELT



Available in even sizes 28"-60"

~~WAS \$8.95~~
\$6⁹⁵

N-04

Belt adjusts two sizes providing for extended wear

NYLON DUTY BELT ACCESSORIES

Baton Holder



N-10

\$7⁹⁵

Baton Holder



N-13

\$5⁹⁵

Gun Holster



Fits:
4" or 6"
revolver
357 magnum
38 revolver
44 magnum
45 long colt

N-14

\$19⁹⁵

Large Pepper Spray Holder



N-07

\$5⁹⁵

Small Pepper Spray Holder



N-05

\$4⁹⁵

Ring Flashlight Holder



~~WAS \$3.95~~

\$1⁹⁵

N-19

Grip Flashlight Holder



\$5⁹⁵

N-22

Double Magazine Holder



\$9⁹⁵

N-23

Double Speed Loader Case



\$9⁹⁵

N-11

Key Holder



\$3⁹⁵

N-15

Radio Holder



\$8⁹⁵

N-25

Handcuff Holders



Single

N-03

\$5⁹⁵

Double

N-31

\$6⁹⁵

Set of 4 Keepers



\$2⁹⁵

N-21

2 1/4" VELCRO BUCKLELESS LEATHER BELTS

Our top grain buckleless leather Velcro® belts offer a professional look. They feature easy to use hidden Velcro® fasteners.

EMBOSSED BUCKLELESS BELT



WAS ~~\$39.95~~
\$19.95 LVEL-01

add \$10.00 for 48-60"



Available in sizes
 Small - XL

Small = 28-32"
 Med = 34-38"
 Large = 40-46"
 XL = 48-60"

CROSS STITCHED BELT



WAS ~~\$39.95~~
\$19.95 PLVEL-01

add \$10.00 for 48-60"

1 1/2" CLASSIC BROWN TROUSER BELT

WAS ~~\$39.95~~

Full grain contast stitched leather belt with brass buckle.



\$14.95 LB-01

add \$10.00 for 48-60"



Available in sizes
 Small - XL

Small = 28-32"
 Med = 34-38"
 Large = 40-46"
 XL = 48-60"

Call for volume discounts

CARRYALL DUTY GEAR BAG

- Organizes all your duty needs
- Durable black nylon construction provides protection for all your gear
- Bag top includes two inside zippered pouches and six pen/pencil slots
- Three exterior open pockets and two zippered end pockets
- Size: 12" H x 18 1/2" W x 7 1/2" D

\$24.95
 BAG-01



Items in bag are not included.

DUTY HOLSTERS BY BIANCHI

ACCUMOLD® & ACCUMOLD® ELITE™ SPEEDBREAK™

For the ultimate in design and function, the Speedbreak™ Duty Holster by Bianchi sets the standard. Featuring Auto Retention™ technology, by which a weapon once holstered, instantly locks into place providing the officer an extra measure of time to control a situation.



AccuMold® Elite™ Speedbreak™ Duty Holster



- AccuMold® Elite™ trilaminate construction with Duraskin™ finish, looks remarkably like leather, but is almost half the weight.
- ThumbLok™ retention device secures weapon internally upon holstering, activating exclusive Auto Retention™ feature
- Features an extended contoured thumb break called KnuckleBreak™, which allows the user to release the thumb break in one smooth motion on the way to the thumb lever
- Injection molded jacket slot belt loop with ErgoTek™ comfort pad
- Tension Bars™ keep holster securely in place
- Fits up to 2 1/4" Duty Belt
- Available in right-handed

\$89⁹⁵

AccuMold® Elite™

| Fits Gun Models | Item # | Model # |
|------------------------|--------|------------|
| Glock 17, 22 | BI-01 | 7935-22902 |
| Glock 19, 23 | BI-02 | 7935-22878 |
| Glock 20, 21 | BI-05 | 7935-22914 |
| HK USP, .40, .45 | BI-03 | 7935-22926 |
| Sig Sauer P220/P226 | BI-04 | 7935-22908 |
| Beretta 92FS/96 Vertec | BI-06 | 7935-22920 |

AccuMold® Speedbreak™ Duty Holster



- AccuMold® Nylon holster features state of the art molding and trilaminate construction to precisely fit the weapon it was designed to carry.
- Weapon drawing is facilitated with a straight downward stroke of the thumb releasing the KnuckleBreak™ on its way to the hidden ThumbLok™ release lever
- Features ErgoTek™ belt loop with comfort pad
- Tension Bars keep holster securely in place
- Single plane drawing motion is natural and fast
- Fits up to 2 1/4" Duty Belt
- Available in right-handed

\$79⁹⁵

AccuMold® Nylon™*

| Fits Gun Models | Item # | Model # |
|------------------------|--------|------------|
| Glock 17, 22 | BI-13 | 7135-22866 |
| Glock 20, 21 | BI-14 | 7135-22870 |
| Glock 19, 23 | BI-20 | 7135-22858 |
| Beretta 92FS/96 Vertec | BI-11 | 7135-22872 |
| Sig Sauer P220/P226 | BI-23 | 7135-22972 |
| HK USP, .40, .45 | BI-24 | 7135-22874 |

***SEE OUR WEB SITE FOR ADDITIONAL SELECTIONS**



LEATHER WALLET



DUTY GEAR

BASKET WEAVE LEATHER WALLET

Leather shield badge and ID holder



Ryno Gear ID-11 **\$9⁹⁵**

Triple K ID-04 **\$16⁹⁵**

Leather wallet with shield badge and ID holder



Ryno Gear ID-12 **\$9⁹⁵**

Triple K ID-08 **\$16⁹⁵**

Leather wallet and star badge and ID holder



Ryno Gear ID-13 **\$9⁹⁵**

Triple K ID-05 **\$16⁹⁵**

PLAIN LEATHER WALLET

Plain leather shield badge and ID holder



Ryno Gear ID-14 **\$9⁹⁵**

Triple K ID-02 **\$15⁹⁵**

Plain leather wallet with shield badge and ID holder



Ryno Gear ID-15 **\$9⁹⁵**

Triple K ID-06 **\$18⁹⁵**

Plain leather star badge and ID holder



Ryno Gear ID-16 **\$9⁹⁵**

Triple K ID-03 **\$15⁹⁵**

MULTI-FUNCTION TOOL

- Stainless steel folding pliers • Knife
- Socket and screw driver with 10 bits
- Nail tool • Bottle opener • Comes with a nylon carry case



\$29⁹⁵

MT-02



Socket and screw driver set with 10 bits

UAW MULTI TOOL & FLASHLIGHT

- Stainless steel folding pliers • Flashlight • Knife • Socket and screw driver with 10 bits • Nail tool • Bottle opener • Comes with a nylon carry case



\$39⁹⁵

MT-01



Socket and screw driver set with 10 bits

Tel: (877) 643-1100 ---- Toll Free
Fax: (877) 700-4477 ---- Toll Free

(818) 341-1500 (US & NON US calls) PST
(818) 341-0015 (US & NON US calls) PST

Phone Ordering
M-F 7am - 5:30pm
Sat 9am - 2pm

59

UAW HIGH QUALITY DURABLE BATONS

Applications: Tactical training, night watchmen, security personnel

21" & 26" EXPANDABLE BATONS



\$24⁹⁵ 21" BT-07 Fully expands to 21 inches. Free nylon holder included.



\$19⁹⁵ 26" BT-01 Fully expands to 26 inches. Free nylon holder included.

24" COLLAPSIBLE BATON



BT-04
\$39⁹⁵

- Solid steel encasing
- Knurled spin-handle grip
- Expands from 14" to 24"
- Locks into extended position until release button pressed



24" SPIN HANDLE



\$29⁹⁵
BT-03

**SAME ALUMINUM BATON
USED BY THE LAPD!**



24" FIXED HANDLE



\$24⁹⁵
BT-02

- Solid steel encasing
- Knurled grip handle has small ridges to aid in gripping



24" PLASTIC HANDLE

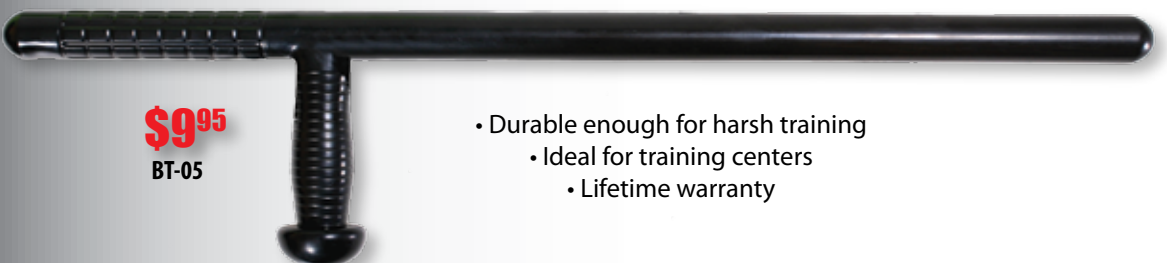

\$9⁹⁵
BT-05

- Durable enough for harsh training
- Ideal for training centers
- Lifetime warranty



Our batons are only sold to Law Enforcement and Security Officers. You must provide proof of occupation/certification with your order.

UAW HIGH QUALITY DURABLE BATON & HOLDERS

21" EXPANDABLE BATON

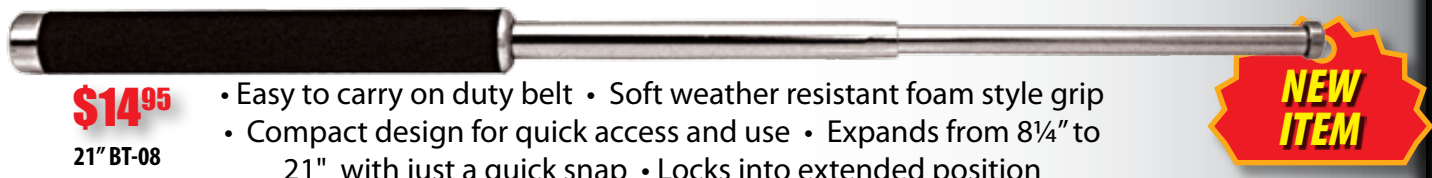

\$14⁹⁵
21" BT-08

- Easy to carry on duty belt
- Soft weather resistant foam style grip
- Compact design for quick access and use
- Expands from 8 1/4" to 21" with just a quick snap
- Locks into extended position



BASKET WEAVE BATON HOLDERS



Easy access basket weave baton holder

Quickly snaps open

\$8⁹⁵
L-25



Ring Holder for Collapsible Baton

\$3⁹⁵
L-13



Collapsible Baton Holder

\$8⁹⁵
L-12



Expandable Baton Holder

\$7⁹⁵
L-10

We accept purchase orders from government institutions, corporations, universities and other companies upon credit approval.



SYNTHETIC LEATHER HOLDERS



Expandable

\$9⁹⁵
SL-10



Ring Holder

\$3⁹⁵
SL-13 Black Snaps
SL-14 Nickel Snaps

NYLON BATON HOLDERS

Expandable Baton Holder

\$7⁹⁵
N-10



Ring Holder

\$3⁹⁵
N-13



PLAIN LEATHER BATON HOLDERS

Expandable Baton Holder

\$9⁹⁵
PL-10



Fits batons with Side Handle (for left and right handed use)

\$9⁹⁵
PL-25



Ring Baton Holder

\$3⁹⁵
PL-13



Tel: (877) 643-1100 ---- Toll Free
Fax: (877) 700-4477 ---- Toll Free

(818) 341-1500 (US & NON US calls) PST
(818) 341-0015 (US & NON US calls) PST

Phone Ordering
M-F 7am - 5:30pm
Sat 9am - 2pm

CHAIN-LINKED HANDCUFFS

- Nickel plated steel for longevity and maximum durability
- 2 inch chain restricts flexibility
- Ratchet jaw
- Double locking
- 2 keys

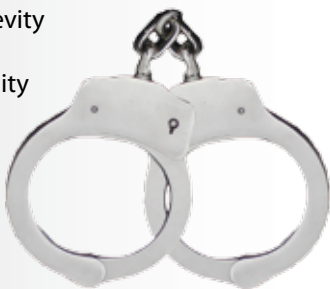

\$9⁹⁵ HC-01

HINGED HANDCUFFS

- Stainless steel
- Double locking
- Ratchet jaw
- 2 keys



HC-02
\$19⁹⁵

EASY CUFFS

Durable construction

Easily slip these on assailant.



\$1⁹⁵
HC-04



KEY CHAIN HANDCUFF KEY



Compatible with all handcuffs on this page

\$1⁹⁵ KHC-01

BODY GUARD FOAM SPRAY LE-10™



Environmentally safe, made from organic ingredients.

- Body Guard is a true pepper spray using the finest quality peppers (10% Oleoresin Capsicum)
- 2 million scovil heat rating source
- Subdues violent suspects quickly and safely
- Proven field use
- Preferred Non-Flammable Formula
- Ozone Friendly 134a Propellant

3.17 oz.
MK-7

\$19⁹⁵

PEERLESS 700 & 700P CHAIN CUFFS

- New spun rivet construction increases the strength and durability of all rivet points, particularly the single strand or jaw rivet point
- Profiled edges minimize the risk of tissue and nerve injury
- Continuously used by correctional officers, F.B.I. Agents, US Marshall Service Personnel, and the military
- Nickel Finish or Black in Carbon steel Pentrate
- 2 keys • Double locking
- Weight: 10 oz.

Lifetime Warranty for Manufacturer's Defects



Black Carbon Steel/Pentrate

\$27⁹⁵
HCP-701

\$27⁹⁵
HCP-700

Nickel Finish

LEG CUFFS BY PEERLESS

- Nickel plated steel
- Double safety lock for additional security
- Special made ditched jaws
- Kick, pick, walk & run proof
- 15 inch linked, welded chain
- Fits any size ankle
- 2 keys



\$39⁹⁵ HCP-702

Leg cuffs by FIRST CLASS Imported

\$19⁹⁵ HC-03

FIRST DEFENSE PEPPER SPRAY

Environmentally safe, made from organic ingredients.

First Defense Pepper Sprays are the premier choice of police and over 5,000 law enforcement agencies around the country. The 10% Oleoresin Capsicum pepper formula burns on contact causing excruciating pain and providing immediate containment of the suspect. Spray effective up to 15 feet.



1.47 oz.
MK-3
\$10⁹⁵

2.5 oz.
MK-4
\$11⁹⁵

.68 oz.
MK-6
\$9⁹⁵

DESIGN YOUR OWN BADGE

IT'S SO EASY ANYONE CAN DO IT!

We at Uniform Warehouse are always looking for innovative ways to improve your experience with us. We are proud to introduce our high quality traditional heavy weight custom badges. They come in gold or silver rhodium electro plating and won't fade or tarnish. Never before has designing your own badge been so easy and intuitive. You create your own badge in 2 quick steps. Here's what you can do!

Choose a badge design...

Our professional pre-made designs have no minimum order requirement and no setup fee. Buy in bulk and save. Add \$19.99 for shipping of any quantity.

| | | | | | | | |
|------------|-------|-------|-------|-------|---------|---------|----------|
| QUANTITY | 1-5 | 6-24 | 25-49 | 50-99 | 100-249 | 250-499 | 500 & up |
| PRICE EACH | 29.99 | 25.99 | 19.99 | 15.99 | 14.99 | 12.99 | 9.99 |

1. DESIGN IT!

- Click on the **Build Your Badge** link on our website www.uniforms4all.com
- Choose from our professional pre-made designs or your own for an extra fee
- Select a center seal from our list of over 80 or even use your logo for an extra fee
- Select the font type (Block or Times New Roman)
- Choose the text color (Black, Blue or Red)
- Indicate the desired text for each banner in your selected design



Badge design
PB-03

Center seal design
Seal-Flag

Font type
 Block Times Other

Text Color
Blue

Banner 1
TEXT HERE

Banner 2
TEXT HERE TEXT HERE

Banner 3
101



Choose from our list of designs

Simply enter your information!

Your finished design!



2. ORDER IT!

We know you have many choices, but no one can beat our quality or our prices. Order your badge with the assurance that our badges come with a 100% Satisfaction Guarantee. Be assured that we always strive to meet your expectations. *(An art fee may apply)*

Tel: (877) 643-1100 ---- Toll Free
 Fax: (877) 700-4477 ---- Toll Free

(818) 341-1500 (US & NON US calls) PST
 (818) 341-0015 (US & NON US calls) PST

Phone Ordering
 M-F 7am - 5:30pm
 Sat 9am - 2pm

DESIGN YOUR OWN CUSTOM BADGES



PB-01
2 1/2" x 3 3/8"



PB-02
2 1/2" x 3 3/8"



PB-03
2 1/2" x 3 3/8"



PB-04
2 1/2" x 3 3/8"



PB-13
2 1/4" x 3 1/4"



PB-14
2 1/4" x 3 1/4"



PB-05
2 1/4" x 3"



PB-06
2" x 3"

**Buy In Bulk
and Save!**

| | | | | | | | |
|-----------------|-------|-------|-------|-------|---------|---------|----------|
| QUANTITY | 1-5 | 6-24 | 25-49 | 50-99 | 100-249 | 250-499 | 500 & up |
| PRICE | 29.99 | 25.99 | 19.99 | 15.99 | 14.99 | 12.99 | 9.99 |

DESIGN YOUR OWN CUSTOM BADGES

BADGES - CUSTOM

PB-15
2 1/4" x 3 1/4"



PB-16
2 1/4" x 3 1/4"



PB-17
2 1/4" x 3 1/4"



PB-18
2 1/4" x 3 1/4"



PB-19
2 1/4" x 3 1/4"



PB-20
2 1/4" x 3 1/4"



PB-21
2 1/4" x 3 1/4"



PB-22
2 1/4" x 3 1/4"



**Buy In Bulk
and Save!**

| QUANTITY | 1-5 | 6-24 | 25-49 | 50-99 | 100-249 | 250-499 | 500 & up |
|----------|-------|-------|-------|-------|---------|---------|----------|
| PRICE | 29.99 | 25.99 | 19.99 | 15.99 | 14.99 | 12.99 | 9.99 |

Tel: (877) 643-1100 ---- Toll Free
Fax: (877) 700-4477 ---- Toll Free

(818) 341-1500 (US & NON US calls) PST
(818) 341-0015 (US & NON US calls) PST

Phone Ordering
M-F 7am - 5:30pm
Sat 9am - 2pm

65

DESIGN YOUR OWN CUSTOM BADGES



PB-09
2 1/4" x 3 3/8"



PB-23
2 1/2" x 3 3/8"



PB-07
3" x 3"



PB-10
2 1/4" x 3 3/8"



PB-24
2 1/2" x 3 3/8"



PB-08
3" x 3"



PB-33
2 3/4" x 3"



PB-34
2 1/2" x 3"

NEW!

NEW!

Buy In Bulk and Save!

| | | | | | | | |
|----------|-------|-------|-------|-------|---------|---------|----------|
| QUANTITY | 1-5 | 6-24 | 25-49 | 50-99 | 100-249 | 250-499 | 500 & up |
| PRICE | 29.99 | 25.99 | 19.99 | 15.99 | 14.99 | 12.99 | 9.99 |

DESIGN YOUR OWN CUSTOM BADGES

BADGES - CUSTOM



PB-11
3" x 3"



PB-12
3" x 3"



PB-27
3" x 3"



PB-25
3" x 3"



PB-26
3" x 3"



PB-28
3" x 3"



PB-29
3" x 3"



PB-30
3" x 3"

**Buy In Bulk
and Save!**

| QUANTITY | 1-5 | 6-24 | 25-49 | 50-99 | 100-249 | 250-499 | 500 & up |
|----------|-------|-------|-------|-------|---------|---------|----------|
| PRICE | 29.99 | 25.99 | 19.99 | 15.99 | 14.99 | 12.99 | 9.99 |

Tel: (877) 643-1100 ---- Toll Free
Fax: (877) 700-4477 ---- Toll Free

(818) 341-1500 (US & NON US calls) PST
(818) 341-0015 (US & NON US calls) PST

Phone Ordering
M-F 7am - 5:30pm
Sat 9am - 2pm

DESIGN YOUR OWN CUSTOM BADGES



PB-31
3" x 3"



PB-32
3" x 3"

**Buy In Bulk
and Save!**

CHOOSE AN ALTERNATE SEAL (SHOWN LIFESIZE)

We offer these attractive center seals and many more online! All at no extra charge!

Want to use a seal not shown? No problem! An extra charge of \$75 applies to create you a custom seal.



Gold Scale (Black)



Gold Scale (Blue)



Gold Scale



Flag



U.S. Eagle (Gold)



U.S. Eagle (Silver)



Globe



Gold Star (Black)



Gold Star (Blue)



Gold Star (Gold)



Pride Eagle (Gold)



Pride Eagle (Silver)



Liberty Bell (Gold)



Liberty Bell (Silver)



US Coat of Arms (Black)



US Coat of Arms (Blue)



US Code of Arms (Gold)



Your State Seal



EMT (Blue)



EMT (Silver)



EMT



Cross (First Aid)



Cross (Rescue)



Fire Truck



Fireman (Volunteer)



F.D. Red
(Also in Blue)



Fireman (Blue)



Fireman (Red)



FD Ranks
(All ranks Available
and in Blue)



Your logo or custom
design available for
custom seals

A one time \$75⁰⁰ mold fee applies

CHOOSE YOUR TEXT AND FINISH

Put your company name, officer name or rank and badge number on any design.

A full color proof can be emailed to you for your approval on request.

OUR POPULAR STOCK BADGE DESIGNS

BADGES - STOCK

• High quality gold or silver rhodium electroplating • Hard enameled seals • Deluxe backings • Lacquered finish • Dark blue text

Private Investigator
(Gold and silver)

3 3/8" x 2 1/4"



\$7⁹⁵

BA-01

Officer Private Security
(Gold and silver)

3 3/8" x 2 1/4"



\$7⁹⁵

BA-02

Security Private Officer
(Gold and silver)

3 3/8" x 2 1/4"



\$7⁹⁵

BA-03

Security Private Officer
(Gold)

3 3/8" x 2 1/4"



\$7⁹⁵

BA-04

Security Enforcement
Officer (Silver)

3" x 2"



\$6⁹⁵

BA-05

Security Enforcement
Officer (Gold)

3" x 2"



\$6⁹⁵

BA-06

Security Officer
(Silver)

3 1/8" x 2 1/4"



\$6⁹⁵

BA-07

Security Officer
(Gold)

3 1/8" x 2 1/4"



\$6⁹⁵

BA-08

Firefighter Volunteer
Fire Dept. (Silver)

3 1/8" x 2 1/8"



\$14⁹⁵

BA-09

Firefighter Volunteer
Fire Dept. (Gold)

3 1/8" x 2 1/8"



\$14⁹⁵

BA-10

Security Officer
(Gold and silver)

3 3/8" x 2 1/4"



\$14⁹⁵

BA-11

Officer Private Security
(Gold and silver)

3 3/8" x 2 1/2"



\$14⁹⁵

BA-12

Tel: (877) 643-1100 ---- Toll Free
Fax: (877) 700-4477 ---- Toll Free

(818) 341-1500 (US & NON US calls) PST
(818) 341-0015 (US & NON US calls) PST

Phone Ordering
M-F 7am - 5:30pm
Sat 9am - 2pm

69

OUR POPULAR STOCK BADGE DESIGNS

• High quality gold or silver rhodium electroplating • Hard enameled seals • Deluxe backings • Lacquered finish • Dark blue text



\$5⁹⁵ BA-13



\$5⁹⁵ BA-14



\$5⁹⁵ BA-15



\$5⁹⁵ BA-16



\$14⁹⁵ BA-17



\$14⁹⁵ BA-18



\$14⁹⁵ BA-19



\$14⁹⁵ BA-20



\$14⁹⁵ BA-21



\$14⁹⁵ BA-22



\$14⁹⁵ BA-23



BA-24 **\$14⁹⁵** BA-39

OUR POPULAR STOCK BADGE DESIGNS

• High quality gold or silver rhodium electroplating • Hard enameled seals • Deluxe backings • Lacquered finish • Dark blue text

Security Officer
(Silver)

3" x 3"



\$14⁹⁵ BA-25

Security Officer
(Gold)

3" x 3"



\$14⁹⁵ BA-26

Security Guard
(Silver)

3 3/8" x 2 3/4"



\$9⁹⁵ BA-27

Security Guard
(Gold)

3 3/8" x 2 3/4"



\$9⁹⁵ BA-28

Private Security Officer
(Silver)

3" x 3"



\$14⁹⁵ BA-29

Private Security Officer
(Gold)

3" x 3"



\$14⁹⁵ BA-30

Security Private Officer
(Silver)

3 3/8" x 2 3/4"



\$14⁹⁵ BA-31

Security Private Officer
(Gold and Silver)

3 3/8" x 2 3/4"



\$14⁹⁵ BA-32

Loss Prevention Officer
(Silver)

3 3/8" x 2 3/4"



\$14⁹⁵ BA-35

Supervisor Private Officer
(Gold and Silver)

3 3/8" x 2 1/2"



\$14⁹⁵ BA-36

Sergeant Private Officer
(Gold and Silver)

3 3/8" x 2 3/4"



\$14⁹⁵ BA-37

Officer Private Security
(Gold and Silver)

3 3/8" x 2 3/8"



\$14⁹⁵ BA-38

Security Hat Badge
1½" x 2½" (Gold)



BA-33

\$12⁹⁵

Security Officer Hat Badge
2¾" x 2½" (Gold)



BA-34

\$14⁹⁵

Mourning Band
Stretches to fit your badge



MB-01

\$1⁹⁵

CHOOSE YOUR BADGE BACKING - SELECTIONS FOR FULL SIZE CUSTOM BADGES



PIN & SAFETY CATCH

Standard style for use on uniform shirts, coats and many leather accessories.



WALLET/BELT CLIP

For use exclusively on your belt or in leather holders. NOT FOR USE WITH RECESSED BELT CLIP HOLDERS.



SCREW & CLUTCH

Standard style for use on uniform hats/caps. NOT FOR USE ON SHIRTS, COATS OR LEATHER CASES.



**PERMANENT MOUNT
NO ATTACHMENT**

Best way for carrying your badge in a leather case. You permanently glue it into your badge holder.

MINIATURE BADGES & LAPEL PINS

Miniature Badge Pins By popular demand...

Our **NEW STOCK** miniature lapel pins are ¾" x 1".

They have a standard lapel pin clutch back.



LPB-01 **\$3⁹⁵**



LPB-02 **\$3⁹⁵**



LPB-03 **\$3⁹⁵**



Mini Badge Pins 1" x ¾"



Center Seal Style Lapel Pins...

Pride Eagle (Gold)



LP-01 **\$2⁹⁵**

Liberty Bell (Gold)



LP-02 **\$2⁹⁵**

Flag (Blue)



LP-03 **\$2⁹⁵**

For custom versions of these lapel pins contact our art department.

Lapel Pins 1" x 1"

MINIATURE SIZE BADGES

By popular demand...

The same high quality as our full size badges. They have a standard pin backing.

NEW!

BADGES - CUSTOM

Create your miniature badges on our web site the same way as our full size ones.

MB-01



MB-02



- 1) Choose your base
- 2) Choose your text
- 3) Choose your seal

MB-03



MB-04



MB-05



MB-06



MB-07



MB-08



MB-09



MB-10



MB-11



MB-12



MB-13



MB-14



MB-15



MB-16



MB-17



MB-18



MB-19



MB-20



MB-21



MB-22



MB-23



MB-24



MB-25



MB-26



MB-27



MB-28



MB-29



MB-30



MB-31



MB-32



Use our Buildyourbadge.com web site for fast accurate service.

| | | | | | | | |
|----------|-------|-------|-------|-------|---------|---------|----------|
| QUANTITY | 1-5 | 6-24 | 25-49 | 50-99 | 100-249 | 250-499 | 500 & Up |
| PRICE | 24.95 | 22.95 | 18.95 | 14.95 | 13.95 | 11.95 | 9.95 |

Tel: (877) 643-1100 ---- Toll Free
 Fax: (877) 700-4477 ---- Toll Free

(818) 341-1500 (US & NON US calls) PST
 (818) 341-0015 (US & NON US calls) PST

Phone Ordering
 M-F 7am - 5:30pm
 Sat 9am - 2pm

SHOULDER EMBLEMS

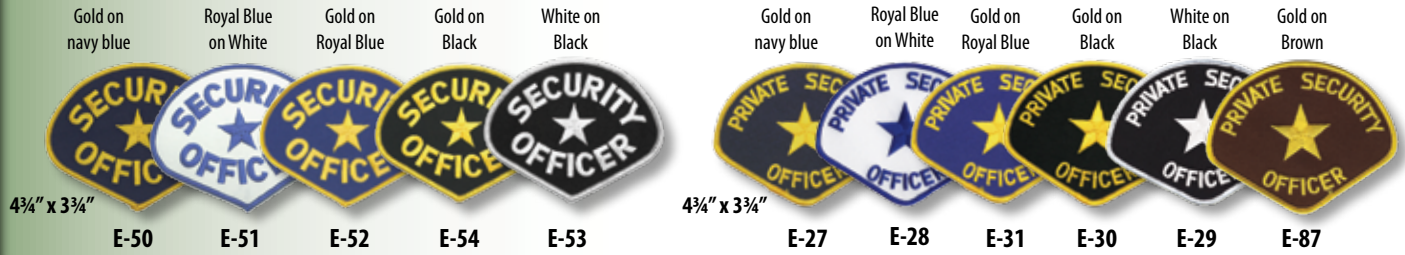

99¢ each



99¢ each



POLICE AND SHERIFF EMBLEMS

Proof of occupation required for these purchases.



CHEST/CAP EMBLEMS



99¢ each

CHEST EMBLEMS



E-56 Gold

\$2⁴⁹

4" x 2"

E-58 Silver



E-06 Gold

99¢ each

4" x 2"

E-18 Silver

UNITED STATES FLAGS

99¢ each

3³/₈" x 2"



E-05 Olive green/black

99¢ each

3³/₈" x 2"

3¹/₂" x 2¹/₄"



E-102 Reverse flag

E-02

99¢ each

3³/₈" x 2"

3¹/₂" x 2¹/₄" at widest part



E-01

E-03

WHAT IS THE PROPER WAY TO WEAR A FLAG ON ONE'S SHOULDER SLEEVE?



Left Shoulder patch (#E-02)



Right Shoulder patch (#E-102)

General Flag Rules do not specifically address the positioning of a flag patch; a decision is left to the discretion of the organization prescribing the wear. Some elect to use the "left" flag on both sleeves. If you are planning to wear only one patch, it is recommended that you wear a "left" flag on your left sleeve.

Military guidelines: To wear our country's flag properly, the field of stars is worn closest to your heart. Further, when worn on the sleeve, the flag should appear to be advancing and not retreating. Thus, if your flag is to be worn on your *LEFT* sleeve, use a left flag. For flags worn on your *RIGHT* sleeve, use a "right" or "reversed field" flag. Source: US Army web site FAQs.



WE ALSO OFFER CUSTOM EMBLEMS MADE USING YOUR DESIGN OR BASED ON OUR HIGH QUALITY SAMPLES

SEE PAGE 79-81 FOR DETAILS



Tel: (877) 643-1100 ---- Toll Free
 Fax: (877) 700-4477 ---- Toll Free

(818) 341-1500 (US & NON US calls) PST
 (818) 341-0015 (US & NON US calls) PST

Phone Ordering
 M-F 7am - 5:30pm
 Sat 9am - 2pm

CHOOSE FROM OUR VARIETY OF RANK CHEVRONS

99¢ each

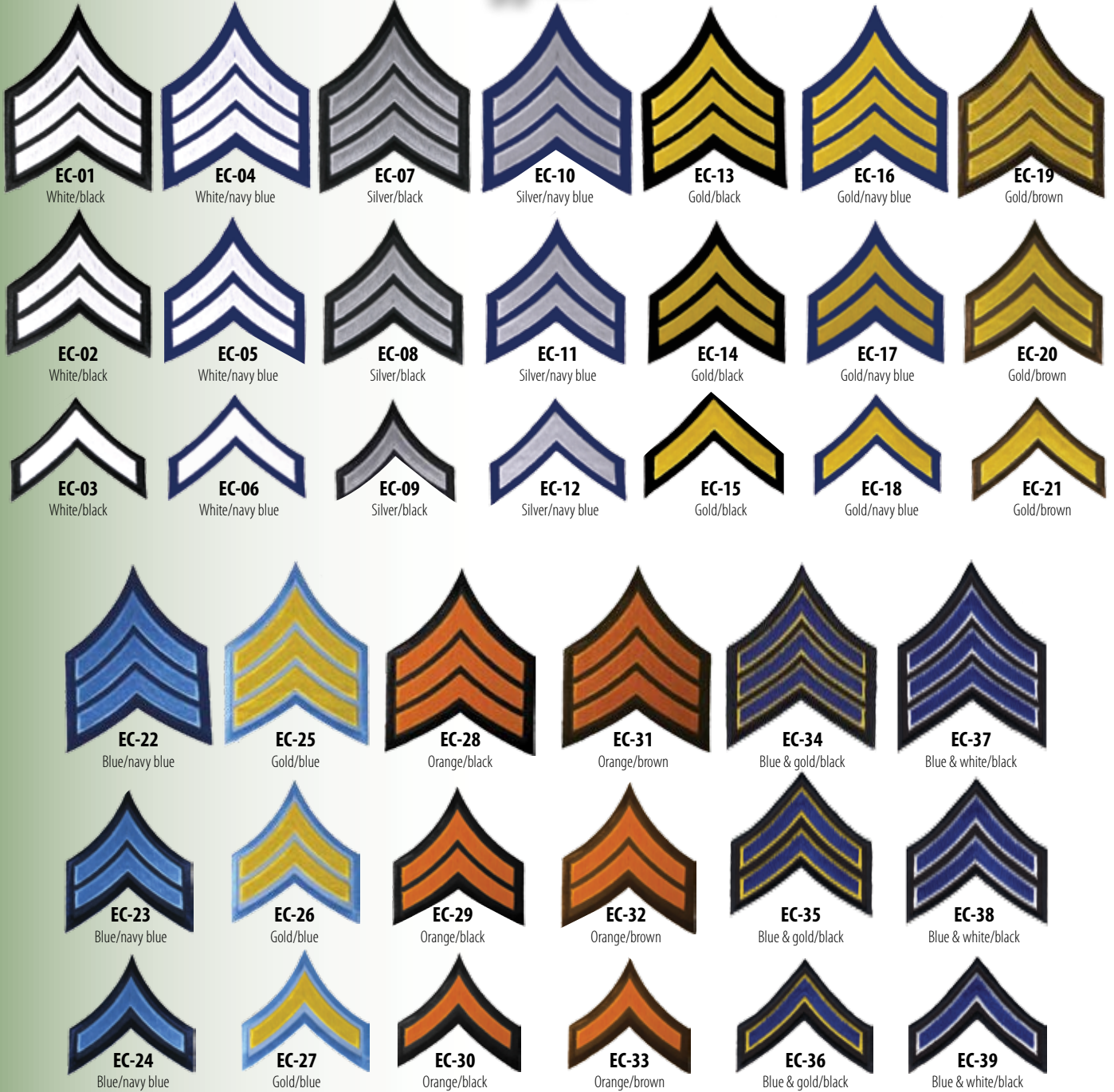

STAFF SGT. CHEVRONS

4 3/4" x 3 1/2"



EMT EMBLEMS



Blue 3 1/2" Circle
Generic EMT Patch
E-48

\$195



Blue/Grey 4" Circle
Los Angeles County
E-41

LARGE EMBROIDERED STOCK EMBLEMS

Proof of occupation is required for all law enforcement emblems.



Gold E-35



Blue E-80



White E-36

\$3⁹⁵ each

All these emblems: 11" x 4"
All lettering is 3" high



Gold E-79



Gold on Brown E-46



Red E-75



Blue E-47



Gold on Black E-55



White on Navy Blue E-57



Gold E-78



Gold on Brown E-81



White E-76



White on Black E-200

\$2⁴⁹ each



Gold on Black E-100



Yellow on Navy Blue E-23



White on Navy Blue E-32

LARGE EMBROIDERED CUSTOM EMBLEMS

WE ALSO OFFER HIGH QUALITY CUSTOM VERSIONS OF OUR LARGE TEXT EMBLEMS

| Quantity | 1-10 | 11-20 | 21-30 | 31-40 | 41-50 | 50-100 | 100+ |
|---------------|---------|--------|--------|--------|--------|--------|--------|
| Approx. Sizes | | | | | | | |
| 11 X 4" | \$14.95 | \$9.95 | \$6.95 | \$5.95 | \$4.95 | \$3.95 | \$2.95 |

*Price per emblem

*These emblems are text only.



Tel: (877) 643-1100 ---- Toll Free
Fax: (877) 700-4477 ---- Toll Free

(818) 341-1500 (US & NON US calls) PST
(818) 341-0015 (US & NON US calls) PST

Phone Ordering
M-F 7am - 5:30pm
Sat 9am - 2pm

TRIBUTE ASSORTMENT



\$11⁹⁵

12": E-09

Over 140,000 stitches

\$3⁹⁵

5": E-11



\$3⁹⁵

5": E-22



\$11⁹⁵

12": E-21

Over 160,000 stitches



Over 160,000 stitches

12" Only
\$11⁹⁵

E-19



Over 160,000 stitches

12" Only
\$11⁹⁵

E-20



Over 160,000 stitches

12" Only
\$11⁹⁵

E-13



5": E-17
\$3⁹⁵



\$11⁹⁵

12": E-49

Over 170,000 stitches

DESIGN YOUR OWN EMBLEM FOR AN UNBELIEVABLY LOW PRICE.

IT'S SO EASY ANYONE CAN DO IT!

At Uniform Warehouse, we are always looking for new and innovative ways to improve your experience with us. We are proud to introduce our custom emblems. Never before has designing your own emblem been so easy and intuitive. You can do it in a few quick steps!

1. DESIGN IT!

- Start with one of our many professional pre-made designs

or...

- Choose from our many shapes and designs and mix & match them to create your own perfect emblem

or...

- Select a design and font type (Block or Times New Roman)
- Choose your text colors (Black, Blue, Red, Gold...)
- Indicate the desired text for each ribbon in your selected design

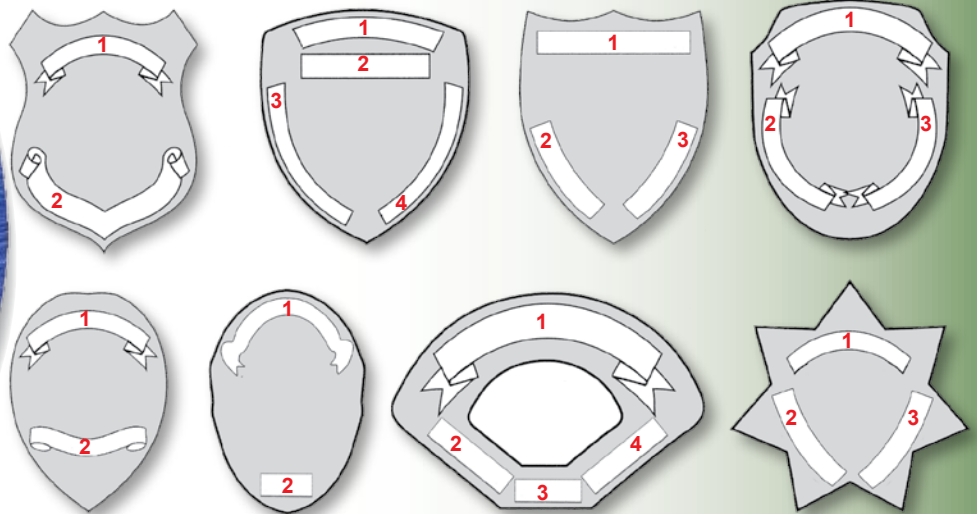

or...

- Use our talented on staff artist to assist in creating your emblem

2. ORDER IT!

We know you have many options, but no one can beat our quality or prices. Order your emblem with the assurance that our emblems come with a 100% Satisfaction Guarantee. *(An art fee may apply)*

ADAPT ANY DESIGN FOR YOUR AGENCY

| | | | | | |
|--|--|-----------------------------------------|--|--|--|
| | | | | | |
| | | CHOOSE FROM OUR POPULAR DESIGNS: | | | |
| | | | | | |
| | | | | | |
| | | | | | |
| | | | | | |
| | | | | | |
| | | | | | |

FOR AN UNBELIEVABLY LOW PRICE



ARTWORK FEE: Use our talented staff artists to create your emblem. The artwork preparation fee is only \$75. It ensures you get the most professional looking product at the lowest possible price.

FOR YOUR CONVENIENCE: Call for details on how we can store and automatically reorder your custom patches. That way you never run out. Your patches are always in stock. Your garment orders can then be tailored and delivered quickly.

HEAT SEAL: A backing that allows you to simply use a hot iron to adhere your patches to most articles of clothing.

PRICE PER EMBLEM FOR 35-85% EMBROIDERY

| Quantity | 20 | 50 | 100 | 200 | 300 | 500 | 1000 | 2000 | 3000 | Heat Seal (Add. each) |
|---------------|------|------|------|------|------|------|------|------|------|-----------------------|
| Approx. Sizes | | | | | | | | | | |
| 2½" x 2½" | 3.99 | 1.75 | 1.19 | .95 | .85 | .75 | .65 | .55 | .49 | .10 |
| 3" x 3" | 4.19 | 2.19 | 1.39 | 1.09 | .95 | .85 | .75 | .65 | .59 | .15 |
| 3½" x 3½" | 4.89 | 2.49 | 1.59 | 1.19 | .99 | .95 | .85 | .75 | .59 | .19 |
| 4" x 4" | 5.89 | 2.79 | 1.85 | 1.29 | .99 | .95 | .85 | .75 | .59 | .25 |
| 4½" x 4½" | 5.99 | 2.89 | 1.89 | 1.59 | 1.29 | 1.09 | .89 | .79 | .69 | .29 |
| 5" x 5" | 6.99 | 3.39 | 2.39 | 1.89 | 1.69 | 1.39 | .99 | .89 | .79 | .39 |



CP-27



CP-101

PRICE PER EMBLEM FOR 100% EMBROIDERY

| Quantity | 20 | 50 | 100 | 200 | 300 | 500 | 1000 | 2000 | 3000 | Heat Seal (Add. each) |
|---------------|------|------|------|------|------|------|------|------|------|-----------------------|
| Approx. Sizes | | | | | | | | | | |
| 2½" x 2½" | 4.19 | 1.95 | 1.29 | .99 | .89 | .79 | .69 | .59 | .55 | .10 |
| 3" x 3" | 4.39 | 2.29 | 1.49 | 1.19 | .99 | .89 | .79 | .69 | .59 | .15 |
| 3½" x 3½" | 5.29 | 2.89 | 1.69 | 1.29 | 1.05 | .99 | .89 | .79 | .69 | .19 |
| 4" x 4" | 5.99 | 2.99 | 1.99 | 1.39 | 1.09 | .99 | .89 | .79 | .69 | .25 |
| 4½" x 4½" | 6.19 | 2.99 | 1.99 | 1.69 | 1.39 | 1.19 | .99 | .89 | .79 | .29 |
| 5" x 5" | 7.19 | 3.59 | 2.49 | 1.99 | 1.89 | 1.39 | 1.09 | .99 | .89 | .39 |



CP-42

Background is solid material in one color.

Entire image is stitched in color.



35-85% EMBROIDERY SAMPLES

100% EMBROIDERY SAMPLES



CP-43



ALSO CALL AND TALK WITH OUR PROFESSIONAL DESIGN TEAM

SEE OUR WEB SITE FOR THE MOST UP-TO-DATE PRODUCTS AND PRICING!

HIGH QUALITY

LOWEST PRICES

FAST DELIVERY

GREAT SERVICE!

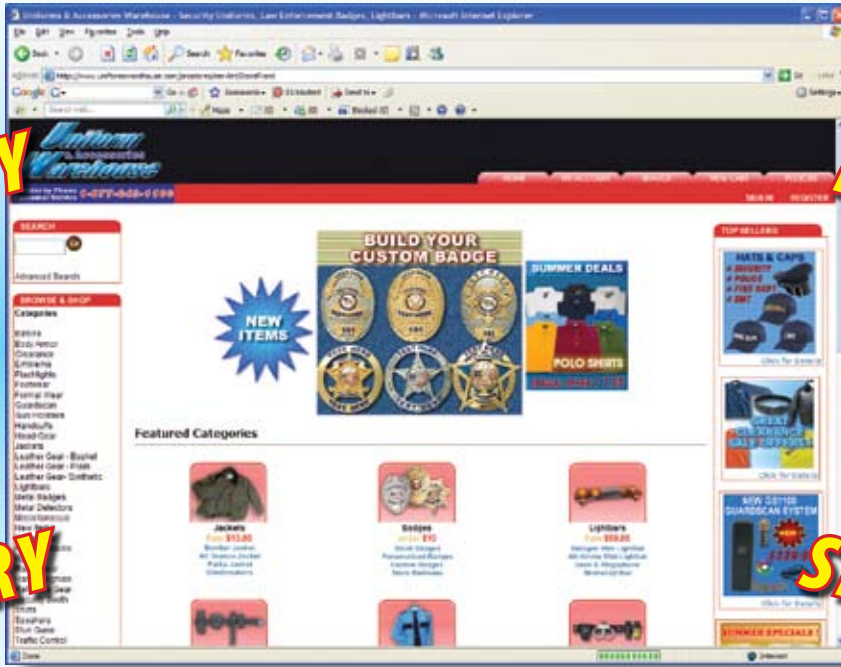

See our web site at www.uniforms4all.com

SEE OUR CUSTOM BUILD YOUR BADGE & BUILD YOUR PATCH SECTIONS



CUSTOM BUILD YOUR OWN BADGES & NAME TAGS

CUSTOM BUILD YOUR OWN PATCHES

Simple to do!

Start from our home page. Just click on the shape or style you like. Next fill in the form with your information. Watch your design build it self before your eyes! You can select from a long list of option. This includes text color, borders, ribbons and artwork for the center! If you still require assistance just call us! Our art staff can help you find what best suits your company, even if it is a completely new design

INSIGNIAS AND ACCESSORIES

Drill Whistle



\$1⁹⁵ ea
 WH-03 Gold
 WH-01 Silver

Snake Whistle Chains



\$1⁹⁵ ea
 IN-07 Gold
 IN-10 Silver

Linked Whistle Chains



\$1⁹⁵ ea
 IN-09 Gold
 IN-08 Silver

Whistle Hook with Clutch back



99¢ ea
 HK-01 Gold
 HK-02 Silver

Handcuff Tie Clip



\$1⁹⁵ ea
 IN-19 Gold
 IN-20 Silver

Plain Tie Clip



\$1⁹⁵ ea
 IN-39 Gold
 IN-30 Silver

Large Sgt. Chevrons 1" x 3/4"



99¢ ea
 IN-15 Gold
 IN-16 Silver

Small Sgt. Chevrons 3/4" x 3/4"



99¢ ea
 IN-23 Gold
 IN-24 Silver

Lieutenant Bars

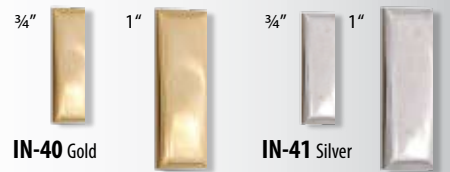

99¢ ea
 IN-40 Gold
 IN-21 Gold
 IN-41 Silver
 IN-22 Silver

Large Corporal Chevrons 1" x 3/4"



99¢ ea
 IN-17 Gold
 IN-18 Silver

Small Corporal Chevrons 1" x 1/2"



99¢ ea
 IN-25 Gold
 IN-26 Silver

Private Stripe 3/4" Long



\$1⁹⁵ ea

Major Pins



\$1⁹⁵ ea
 IN-27 Gold
 IN-28 Silver
 IN-88 Gold
 IN-89 Silver

Large Captain Bars 1" x 1"



99¢ ea
 IN-13 Gold
 IN-14 Silver

Small Captain Bars 3/4" x 3/4"



99¢ ea
 IN-03 Gold
 IN-04 Silver

Ribbon Flag 1" high



95¢ ea
 US-02

Rectangle Flag

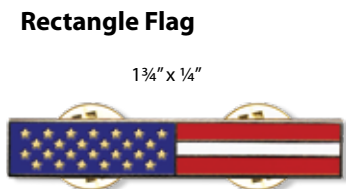

\$1⁹⁵ ea
 US-04

1 1/2" x 3/8"



\$1⁹⁵ ea
 US-05

Rectangle Flag











































95¢ ea
 US-01

Wavy Flag 3/4" x 3/4"



95¢ ea
 US-03

INSIGNIA AND ACCESSORIES

| | | | |
|--------------------------------------------------------------------------------------------------------------------------------------------------------------------------------------------------------------------------------------------------------------------------------------------------------------|-------------------------------------------------------------------------------------------------------------------------------------------------------------------------------------------------------------------------------------------------------------------------------------------------------------|----------------------------------------------------------------------------------------------------------------------------------------------------------------------------------------------------------------------------------------------------------------------------------------------------------------|-------------------------------------------------------------------------------------------------------------------------------------------------------------------------------------------------------------------------------------------------------------------------------------------------|
| <p>Police Pin 3/8"</p> <p> IN-52 Gold</p> <p> IN-53 Silver</p> <p>\$195 ea</p> | <p>Officer Pin - 1/4"</p> <p> IN-54 Gold</p> <p> IN-55 Silver</p> <p>\$195 ea</p> | <p>Deputy Pin - 1/4"</p> <p> IN-56 Gold</p> <p> IN-57 Silver</p> <p>\$195 ea</p> | |
| <p>Sheriff Pin 1/4"</p> <p> IN-58 Gold</p> <p> IN-59 Silver</p> <p>\$195 ea</p> | <p>Chief Pin - 3/8"</p> <p> IN-60 Gold</p> <p> IN-61 Silver</p> <p>\$195 ea</p> | <p>Security Pin - 1/4"</p> <p> IN-05 Gold</p> <p> IN-06 Silver</p> <p>\$195 ea</p> | |
| <p>SO Pin - 1/2"</p> <p> IN-50 Gold</p> <p> IN-51 Silver</p> <p>99c ea</p> | <p>PD Pin - 1/2"</p> <p> IN-62 Gold</p> <p> IN-63 Silver</p> <p>\$195 ea</p> | <p>FD Pin - 3/8"</p> <p> IN-64 Gold</p> <p> IN-65 Silver</p> <p>\$195 ea</p> | <p>K-9 Pin - 1/2"</p> <p> IN-66 Gold</p> <p> IN-67 Silver</p> <p>\$195 ea</p> |
| <p>SP Pin - 1/2"</p> <p> IN-68 Gold</p> <p> IN-69 Silver</p> <p>\$195 ea</p> | <p>Swat Pin - 3/8"</p> <p> IN-70 Gold</p> <p> IN-71 Silver</p> <p>\$195 ea</p> | <p>EMT Pin - 3/8"</p> <p> IN-72 Gold</p> <p> IN-73 Silver</p> <p>\$195 ea</p> | <p>EMS Pin - 3/8"</p> <p> IN-74 Gold</p> <p> IN-75 Silver</p> <p>\$195 ea</p> |
| <p>Fire Bugle - Lieutenant - 3/4"</p> <p> IN-76 Gold</p> <p> IN-77 Silver</p> <p>\$195 ea</p> | <p>Fire Bugle - Captain 1 - 3/4"</p> <p> IN-78 Gold</p> <p> IN-79 Silver</p> <p>\$195 ea</p> | <p>Fire Bugle - Captain 2 - 3/4"</p> <p> IN-80 Gold</p> <p> IN-81 Silver</p> <p>\$195 ea</p> | |
| <p>Fire Bugle - Asst. Chief - 3/4"</p> <p> IN-82 Gold</p> <p> IN-83 Silver</p> <p>\$195 ea</p> | <p>Fire Bugle - Dep. Chief - 3/4"</p> <p> IN-84 Gold</p> <p> IN-85 Silver</p> <p>\$195 ea</p> | <p>Fire Bugle - Chief - 3/4"</p> <p> IN-86 Gold</p> <p> IN-87 Silver</p> <p>\$195 ea</p> | |

OFFICER RANK INSIGNIAS

Large & Small Single Captain Stars



Two Stars



Three Stars



Four Stars



FIVE STARS

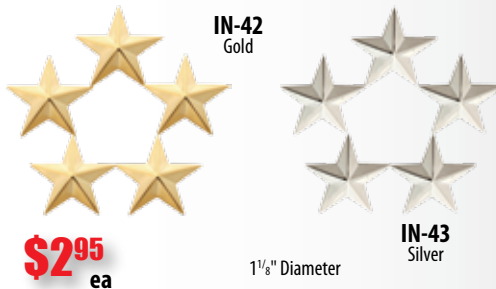

ENGRAVED NAME TAGS

We can engrave your one or two lines of text on these name tags.

\$5⁹⁵

5/8" X 2 1/2"

Order 50 or more and get them for only **\$4.95**

Production time is 2 days - 1 week

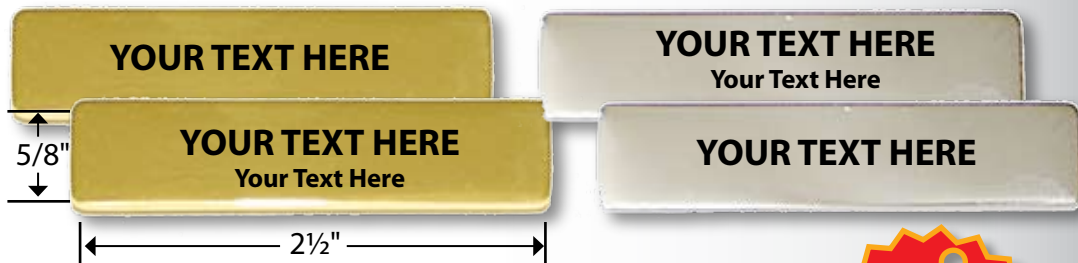

| GOLD | Pin Back | Clutch Back | Magnate Back |
|--------|----------|-------------|--------------|
| | NT-01G | NT-04G | NT-03G |
| SILVER | Pin Back | Clutch Back | Magnate Back |
| | NT-02S | NT-05S | NT-06S |



Black text only

PLASTIC NAME TAGS



\$5⁹⁵

Item: PNT-01

| Qty | Price |
|---------|--------|
| 1-9 | \$5.95 |
| 10-50 | \$3.95 |
| 51-100 | \$2.95 |
| 101-500 | \$1.95 |
| 500+ | \$0.95 |



- FULL COLOR
- LIGHTWEIGHT

Call for production time

An art fee may be requires. Ask our staff prior to ordering this item.

Tel: (877) 643-1100 ---- Toll Free
Fax: (877) 700-4477 ---- Toll Free

(818) 341-1500 (US & NON US calls) PST
(818) 341-0015 (US & NON US calls) PST

Phone Ordering
M-F 7am - 5:30pm
Sat 9am - 2pm

TWO TONE ENGRAVED NAME TAGS

Our two tone name tags have a brushed silver border with a polished gold center.

\$5⁹⁵
Each



Production time is 2 days - 1 week

| GOLD/Silver | Pin Back | Clutch Back | Magnate Back |
|-------------|----------|-------------|--------------|
| | NT-19G | NT-20G | NT-21G |

Order 50 or more and get them for only \$3.95

ENGRAVED SERVING SINCE NAME TAGS

These name tags have a polished gold surface.

We can engrave your one or two lines of text and the required date on these name tags.



| GOLD | Pin Back | Clutch Back | Magnate Back |
|--------|----------|-------------|--------------|
| | NT-13G | NT-14G | NT-15G |
| SILVER | Pin Back | Clutch Back | Magnate Back |
| | NT-16S | NT-17S | NT-18S |

Order 50 or more and get them for only \$4.95

Production time is 2 days - 1 week

\$6⁹⁵
Each

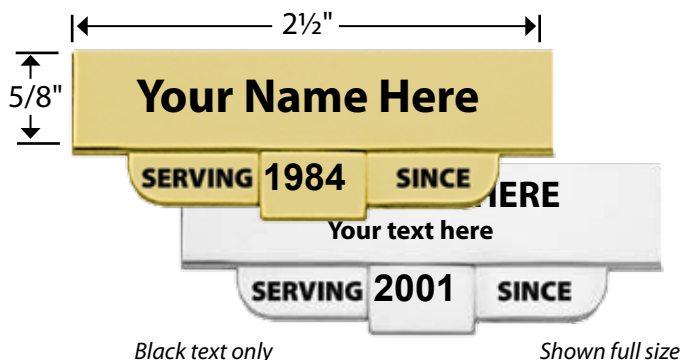

PATRIOTIC ENGRAVED NAME TAGS WITH USA FLAG

These name tags have a polished gold or silver surface and smooth rounded edges.

We can engrave your one or two lines of text on these patriotic name tags.

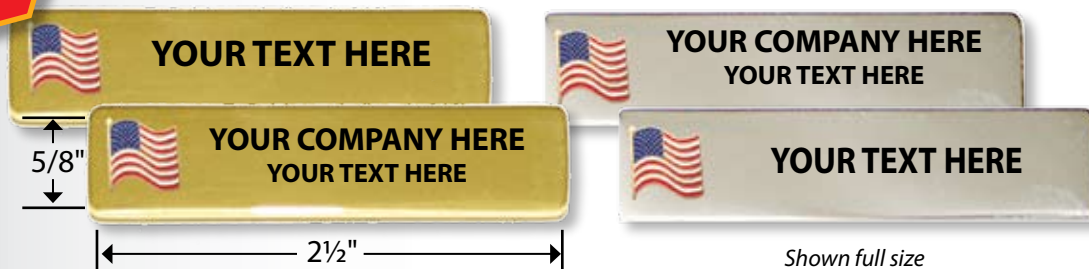

5/8" X 2 1/2" with US Flag

Order 50 or more and get them for only \$4.95

Production time is 1 week

| GOLD | Pin Back | Clutch Back | Magnate Back |
|--------|----------|-------------|--------------|
| | NT-07G | NT-08G | NT-09G |
| SILVER | Pin Back | Clutch Back | Magnate Back |
| | NT-10S | NT-11S | NT-12S |

\$6⁹⁵
Each

Black text only

THE GUARDSCAN SYSTEM

- ◆ WHY YOUR AGENCY SHOULD HAVE OUR GUARDSCAN MANAGEMENT SYSTEM ◆
 - ARE YOU LOSING CUSTOMERS?
 - DO YOU WANT TO INCREASE YOUR CUSTOMER BASE?
- ◆ WE HAVE A SOLUTION FOR YOU! ◆
 - PROVE THAT YOU OFFER THE BEST SERVICE WITH THE GUARDSCAN SET.

ATTRACT NEW CUSTOMERS & BRING EXISTING CUSTOMERS TO A NEW LEVEL OF PROFESSIONALISM WITH THE GUARDSCAN MANAGEMENT SYSTEM.

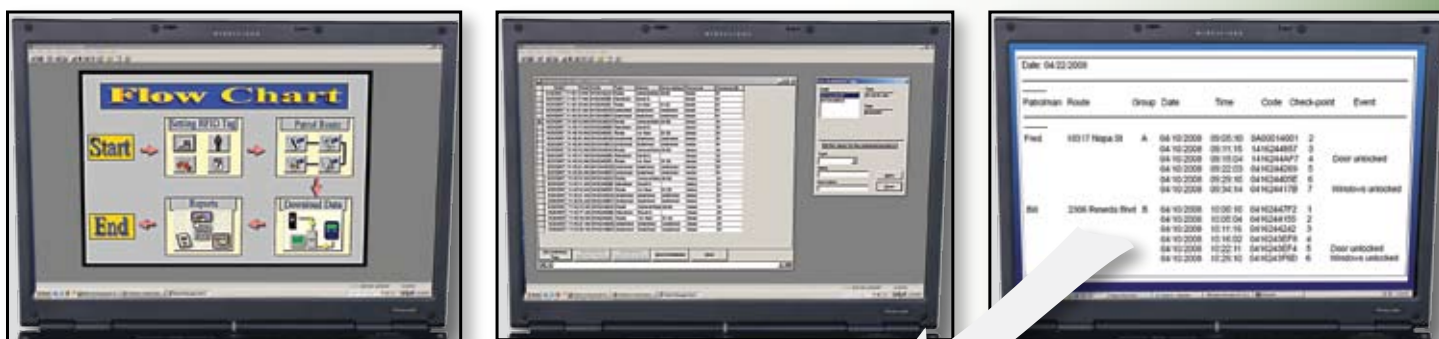

This system functions easily as a hand-held data terminal. You simply scan each RFID (radio frequency identification) tag you place at check points you choose on a patrol route. Guard accountability increases as each guard must scan the tags to validate each check point. By scanning the tag, the date, time, location and any other incidentals will be logged into the data terminal. Download the information from the remote scanner to your computer and print simple and comprehensive professional reports to be reviewed with current and potential clients.

Patrol Tour Report

| Patrolman | Route | Group | Date | Time | Code | Check-point | Event |
|-----------|------------------|-------|------------|----------|------------|-------------|------------------|
| Fred | 18317 Napa St | A | 04/10/2008 | 09:05:10 | 0A00014001 | 2 | |
| | | | | 09:11:15 | 1416244857 | 3 | |
| | | | | 09:15:04 | 1416244AF7 | 4 | Door unlocked |
| | | | | 09:22:03 | 0416244269 | 5 | |
| | | | | 09:29:10 | 041624405E | 6 | |
| | | | | 09:34:14 | 041624417B | 7 | Windows unlocked |
| | | | | 10:00:10 | 04162447F2 | 1 | |
| Bill | 2306 Reseda Blvd | B | 04/10/2008 | 10:05:04 | 0416244155 | 2 | |
| | | | | 10:11:16 | 0416244242 | 3 | |
| | | | | 10:16:02 | 0416243EF8 | 4 | |
| | | | | 10:22:11 | 0416243EF4 | 5 | Door unlocked |
| | | | | 10:29:10 | 0416243F6D | 6 | Windows unlocked |
| | | | | | | | |

FREE Patrol Manager software valued at \$99.95 when you buy your 1st set of The Guardscan Management System

THE GS2000 SYSTEM



Features durable metal housing and hassle-free USB data transfer to the base station.

GS 2000 Scanner Set

- Remote scanner
- *(Requires scanner base. Sold separately)
- Nylon holder
- Ring holder for scanner
- Patrol manager software (for 1st time buyer only)
- 1 C size battery
- 4 RFID tags



GS-2000

Specification:

- Memory capacity: 14,320 records
- Up to 100,000 scans on one C battery
- Dimensions: 6.6"H x 2"W
- Weight: 10.9oz

PRICE REDUCTION NOW ONLY
\$199⁹⁵

Retail \$499⁹⁵

GS 2000 Scanner Base



\$99⁹⁵

- Scanner base can be used with multiple scanners.
- Allows data transfer by USB connector to Patrol Manager software



Parts sold separately

- GS-2000USB Scanner base.....\$99.95
- RFI-01 RFID tags.....\$1.95

Tel: (877) 643-1100 ---- Toll Free
Fax: (877) 700-4477 ---- Toll Free

(818) 341-1500 (US & NON US calls) PST
(818) 341-0015 (US & NON US calls) PST

Phone Ordering
M-F 7am - 5:30pm
Sat 9am - 2pm

THE GUARDSCAN SYSTEM

THE GS1100 SYSTEM



GS-1100

Upon receipt of your Guardscan Management System Set, scan each tag into your computer using your free software.

Set Includes:

- Remote Scanner • Leather holder • Belt clip for leather holder • 1 AA size battery • Patrol manager software (for 1st time buyer only)
- USB data download cable • 4 RFID tags

New Features:

- Vibration feedback upon scanning of each RFID tag
- Single alkaline battery is easy to replace and lasts up to 50,000 scans
- Lightweight, only 5.4oz with battery



EVENT WALLET

Tags sold separately for each system **\$1⁹⁵**

KP-1000
\$29⁹⁵

RFI-01
Strategically place tags at desired check-points.

UPGRADE TODAY FROM THE GS1000

GS1000 users can upgrade to the new GS1100 and keep their existing software.

- M-09 Scanner case.....\$19.95
- RFI-01 RF ID tags.....\$1.95

USE OF THE GUARDSCAN AND THE EVENT WALLET



~~Retail \$499⁹⁵~~

THE GS3000 SYSTEM



GS-3000 Scanner
\$119⁹⁵

Buy 100+ Scanners and save 10%

GS-3001 Base Unit
\$79⁹⁵

See page 4 for a sample report

- Durable stainless steel body with rubber grip is shock and water resistant
- Scanner records Date, Time, and ID information of each checkpoint visited
- Built-in battery lasts up to 400,000 scans (aprox. 2 years)
- Weight: 11.3 oz • Size: 5¾" H x 1½" L x 1½" W • Easy to use software

- | | | |
|-------------------------------------------|-------------------------------------------|-------------------------------------------|
| Tag & Holder | Tag Holder | Button Tags |
| | | |
| GS-3004 \$3⁹⁵ | GS-3003 \$1⁹⁵ | GS-3002 \$2⁹⁵ |

PATROL TOUR SYSTEM SET

\$199⁹⁵ GS-3000A

Includes:

- 1 - Remote scanner • 1 - Base unit • 10 Button tags • USB transfer cable • Patrol Management Lite software

GARRETT PD 6500I WALKTHROUGH

The PD 6500i is the world's highest performing walk-through metal detector and leads the industry with superior pinpoint technology and unmatched discrimination and sensitivity features. Designed for maximum patron throughput without compromising safety, the PDi is the walk-through of choice for security professionals worldwide.

- Easy Assembly
- 33 Distinct Pinpoint Detection Zones
- Entry Pacing Lights
- Overhead Control Unit
- Multi-dimensional Coil Design
- Audible and Visual Alarms
- Access Control Panel



The PD 6500i's Access Control Panel is designed

for use by authorized personnel with specific, multi-level security codes. It allows authorized users to change settings such as detection Program and Sensitivity. Security of the detector's settings is maintained with a non-resettable sequence code, which indicates every attempt at access to the settings. A tamper alarm sounds within 10 seconds after the Access Touch pad is pressed, unless a proper access code is entered.

The PD 6500i maintains all settings even when disconnected from power and does not require recalibration each time the unit is turned OFF and back ON. No battery is required for memory retention.



Suggested retail price: \$5,945.00

\$3,895⁹⁵

PD-6500i



GARRETT MT 5500 WALKTHROUGH

The MT 5500 is one of the world's most popular walk-through metal detectors because it provides maximum throughput with unparalleled multi-dimensional scanning. The MT 5500 meets the demanding needs of security professionals worldwide who trust its ability to maintain a high flow rate with minimal alarms.

- Easy Assembly
- Multi-Dimensional Scanning
- Microprocessor Controlled
- Audible and Visual Alarms
- Detection Field
- Access Control Panel

The Access Control Panel is designed for use by authorized personnel with specific security codes. It allows authorized users to change



settings such as Program and Sensitivity. Security of the detector's settings is maintained with a non-resettable sequence code, which indicates every attempt at access to the settings. A tamper alarm sounds within 10 seconds after the Access touch pad is pressed unless a proper access code is entered.

The MT 5500 includes 20 standard programs, which are maintained in an electrically erasable non-volatile memory, for the ultimate in security application versatility. The unit maintains all settings even when disconnected from power and does not require recalibration when unit is turned OFF and back ON. No battery is required for memory retention.



Suggested retail price: \$4,995.80

\$3,495⁹⁵

PD-5500

Tel: (877) 643-1100 ---- Toll Free
 Fax: (877) 700-4477 ---- Toll Free

(818) 341-1500 (US & NON US calls) PST
 (818) 341-0015 (US & NON US calls) PST

Phone Ordering
 M-F 7am - 5:30pm
 Sat 9am - 2pm

WE002 WALK THROUGH METAL DETECTOR

Designed for security professionals that are looking for a full-featured metal detector at an unbeatable value, the WE002 exceeds or meets specifications of more expensive brand names. By using six overlapping detection zones, the multi-channel metal detector can detect with pinpoint accuracy the location of metal objects. Advanced microprocessor technology allows you to selectively adjust the sensitivity in each detection zone.

- Easy Assembly
- 6 Distinct Pinpoint Detection Zones
- Audible and Visual Alarms
- Overhead Control Unit
- 100 Sensitivity Levels

Compound circuit design allows visible count of people who have passed through. With the help of DSP technology, false alarms are minimized. Password protected access panel maintains security of all the detector's settings.

Door size: 79"H x 27 1/2"W x 19"D
 Frame size: 87"H x 31"W x 19"D

NOW OFFERING WEEKLY RENTAL IN SOUTHERN CALIFORNIA ONLY
 \$499.95/week (Not including shipping and handling).
 Call for details and availability.

We accept purchase orders from government institutions, corporations, universities and other companies upon credit approval.



\$1499⁹⁵

MD-15

Suggested retail price
 \$3,000.95

RENTAL

\$499⁹⁵/week

Southern California area only.
 Please call for availability

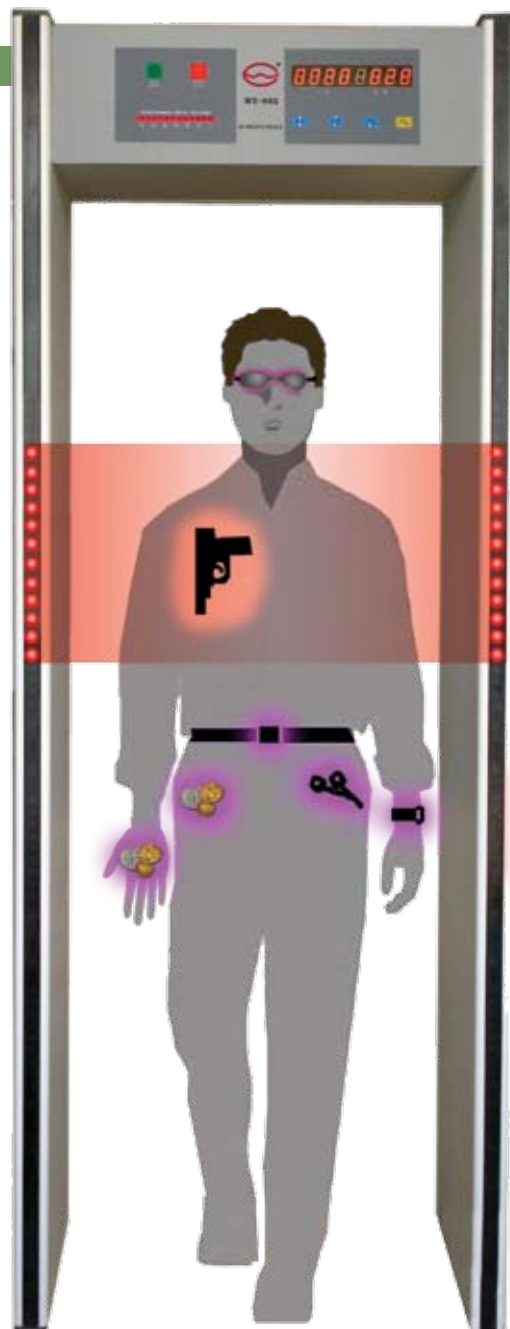

SCANNER HANDHELD METAL DETECTOR

- Simple & convenient operation
- Audio and LED alerts
- Lightweight ABS structure
- Automatic battery check
- Automatic reset switch for sensitivity change
- Requires 9V battery not included
- Size: 16¼" x 3½"



GARRETT SUPERWAND

The new Garrett SuperWand features an ergonomic grip to fit comfortably in every hand.

Detecting all metallic objects, the Garrett SuperWand is ideal for use in government facilities, security operations, hospitals, banks, and community events.



Users can choose between an audible and silent vibrate/LED lights alarm signal. The easy one-touch button & three-color display operation uses red, green & amber LED lights. Because it automatically retunes, the Garrett Super Wand requires absolutely no adjusting. The rugged injection molded construction features a structurally separate coil for increased impact absorption, yet the Garrett SuperWand is a light 16 ounces. Powered by a single 9V battery.

\$189⁹⁵ MD-20

Please call our toll-free number for special discounts when you purchase 50 units or more.

SCANNER HANDHELD METAL DETECTOR

- Simple & convenient operation
- Audio and LED alerts
- Lightweight ABS structure
- Automatic battery check
- Automatic reset switch for sensitivity change
- Requires 9V battery not included
- Size: 16¼" x 3½"

\$49⁹⁵ MD-01



HANDHELD METAL DETECTORS

- Small, lightweight and easy to use
- Detects both ferrous and non-ferrous metal
- Audible and visible alarms
- Requires 9V battery (not included)
- Alerts when battery is low
- Size: only 13¾" inches long!

\$24⁹⁵

MD-10

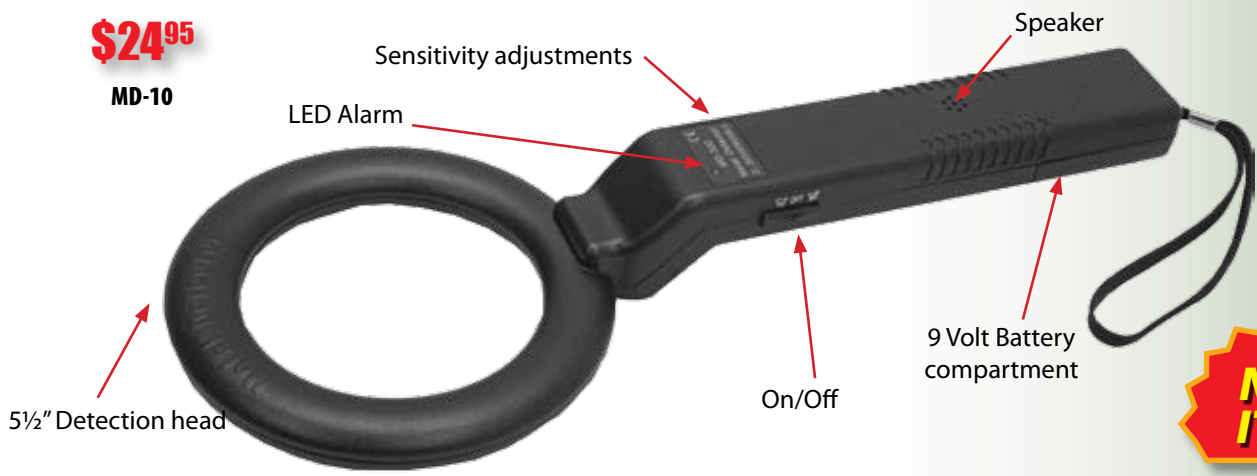

Tel: (877) 643-1100 ---- Toll Free
 Fax: (877) 700-4477 ---- Toll Free

(818) 341-1500 (US & NON US calls) PST
 (818) 341-0015 (US & NON US calls) PST

Phone Ordering
 M-F 7am - 5:30pm
 Sat 9am - 2pm



VANGUARD 3000 SERIES HIGH

For maximum warning power, choose from our Vanguard Ultra

55" VANGUARD 3000 LED

Front View



- 26 new improved high intensity modules with 4 LEDs each that are 20% brighter
- Ultra slim profile with clear lens for a stealth look
- Choose from 7 flash patterns
- Built-in amber arrowstick lings on the back

Rear View

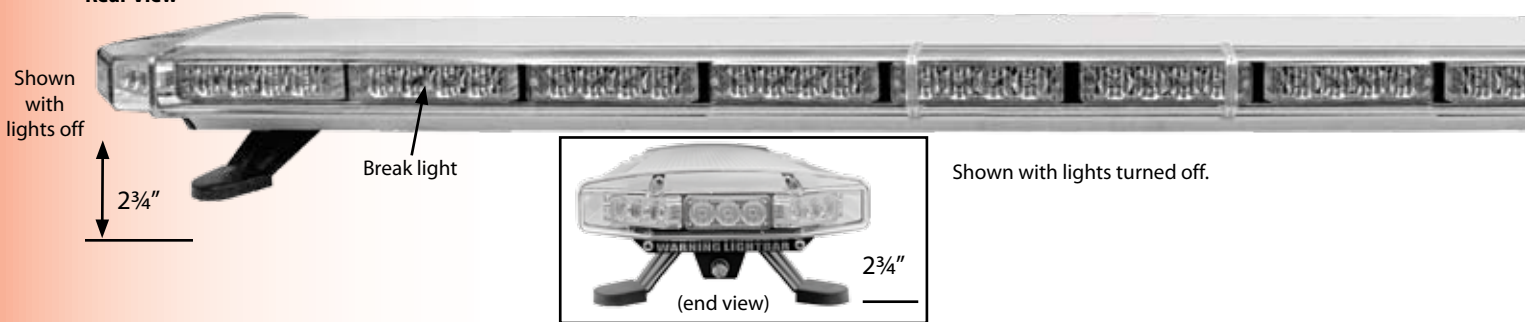

Shown with lights turned off.

46" VANGUARD 3000 LED LIGHTBARS

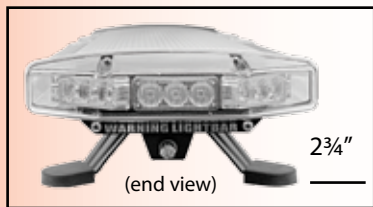
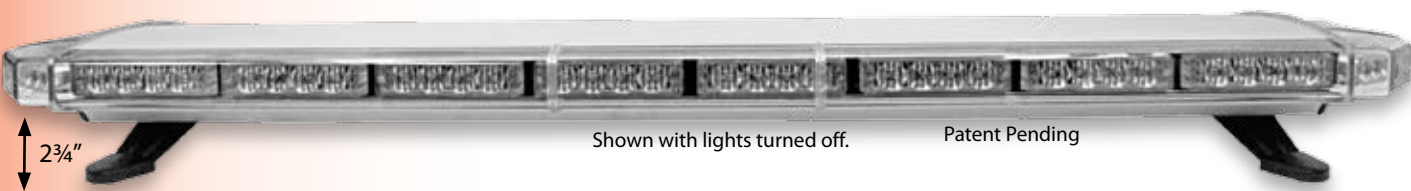

Retail Price \$2000⁹⁹

Amber only
Other colors
available at
\$39.00 extra

- 22 new improved high intensity modules with 4 LEDs each that are 20% brighter
- Choose from 7 flash patterns
- Directional traffic advisor on the back
- 2 LED take-down and 2 LED alley lights
- Includes universal mounting kit, 7 button control box and 12 feet power cable
- Dimensions: 1.78"H x 12"W x 46"L

7 BUTTON CONTROL BOX



| LED COLOR | ITEM # |
|-----------|-------------------|
| | Amber LED-3005 |
| | Red LED-3006 |
| | Red/Blue LED-3007 |
| | Green LED-3008 |
| | Blue LED-3009 |

Replacement LED modules available in these colors:

A R B G C \$29.00 each LEM-07
Please specify color when ordering

H INTENSITY LED LIGHTS

ra Series featuring some of the brightest LEDs on the market.



TOW TRUCK LIGHTBARS



Patent Pending

- 2 LED take-down lights and 2 LED alley lights
- Includes universal mounting kit and 7 button control box
- Ideal for fire trucks, tow trucks and oversized vehicles
- 12 foot power cord (12V DC)
- 1.78"H x 12"W x 55"L

Retail Price
\$2700⁹⁹



Amber only
Other colors
available at
\$79.00 extra

7 BUTTON CONTROL BOX



| LED COLOR | ITEM # |
|-----------|--------------------------|
| | Amber LED-3605 |
| | Red LED-3606 |
| | Red/Blue LED-3607 |
| | Green LED-3608 |
| | Blue LED-3609 |

Replacement LED modules available in these colors:

A **R** **B** **G** **□** **\$29.00** each **LEM-07**
Please specify color when ordering



27" VANGUARD HALF SIZE LIGHTBAR & 15" VANGUARD MINI LIGHTBAR



Shown with lights turned off.

Clear domes

2 1/2"

Retail Price
\$899⁹⁹



Other colors
available at
\$29.00 extra

3 BUTTON CONTROL BOX



| LED COLOR | ITEM # |
|-----------|-----------------|
| Amber | LED-3055 |
| Red | LED-3056 |
| Red/Blue | LED-3057 |
| Green | LED-3058 |
| Blue | LED-3059 |

- 14 new improved high intensity modules with 4 LEDs each that are 20% brighter
- Ultra slim profile and clear lens for a stealth look
- 7 selectable flash patterns
- 2 LED alley lights
- Includes magnetic mount, 3 button control box & 12 foot power cord (12V DC) with cigarette adapter
- Size: 3"H x 12"W x 27"L

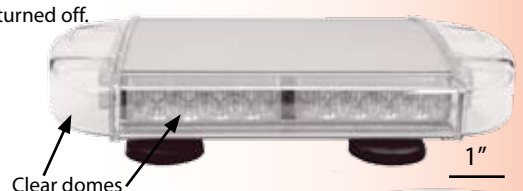

Clear domes

1"

Retail Price
\$495⁹⁹



Other colors
available at
\$19.00 extra

| LED COLOR | ITEM # |
|-----------|-----------------|
| Amber | LED-3025 |
| Red | LED-3026 |
| Red/Blue | LED-3027 |
| Green | LED-3028 |
| Blue | LED-3029 |



(end view)

2 Btn Control Switch



- 6 new improved high intensity modules with 4 LEDs each that are 20% brighter
- Ultra slim profile for an aerodynamic look
- 7 selectable flash patterns
- Includes magnetic mount and 2 button control switch on the 12 foot power cord with cigarette plug (12V DC)
- Size: 3"H x 8 1/4"W x 14 1/2"L

Replacement LED modules available in these colors:
LEM-07
A **R** **B** **G** **□** **\$29.00** each
Please specify color when ordering

Tel: (877) 643-1100 ---- Toll Free
Fax: (877) 700-4477 ---- Toll Free

(818) 341-1500 (US & NON US calls) PST
(818) 341-0015 (US & NON US calls) PST

Phone Ordering
M-F 7am - 5:30pm
Sat 9am - 2pm

STREAMLINED ULTRA SERIES HIGH INTENSITY

For incredible warning power, choose from our Streamlined Ultra

55" STREAMLINED ULTRA

Front View

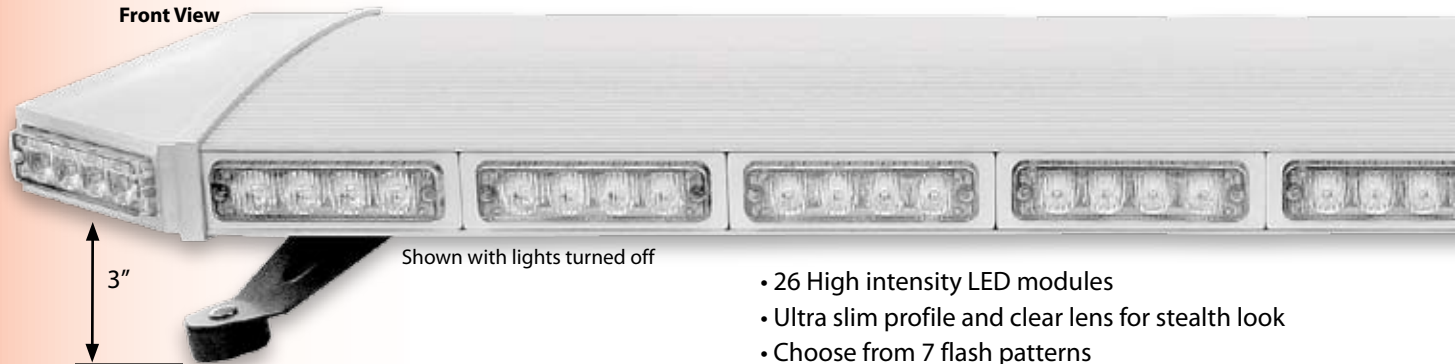

Shown with lights turned off

- 26 High intensity LED modules
- Ultra slim profile and clear lens for stealth look
- Choose from 7 flash patterns
- Built-in amber arrowstick and break lights on back

Rear View



Shown with lights turned off

46" STREAMLINED ULTRA LED LIGHTBARS



Shown with lights turned off

US Patent No: D545,230

Retail Price
\$1979⁹⁹







Amber only
Other colors
available at
\$39⁰⁰ extra



7 BUTTON CONTROL BOX



- 22 High intensity LED modules
- Ultra slim profile and clear lens for stealth look
- Choose from 7 flash patterns
- Built-in amber arrowstick on the back
- 2 LED take-down lights and 2 LED alley lights
- Includes universal mounting kit and 7 button control box
- 12 foot power cord (12V DC)
- 1.78"H x 12"W x 46"L

| LED COLOR | ITEM # |
|------------------------------------------------------------------------------------------------|----------|
|  Amber | LED-2005 |
|  Red | LED-2006 |
|  Red/Blue | LED-2007 |
|  Green | LED-2008 |
|  Blue | LED-2009 |

Replacement LED modules available in these colors:

A R B G C \$29⁰⁰ each LEM-01
Please specify color when ordering

TENSITY LED TOW TRUCK LIGHTS

Ultra Series featuring some of the brightest LEDs on the market.

ULTRA LED LIGHTBARS



US Patent No: D545, 230

- Ideal for fire trucks, tow truck and oversized vehicles
- 2 LED take-down lights and 2 LED alley lights
- Includes universal mounting kit and 7 button control box
- 12 foot power cord (12V DC)
- 1.78"H x 12"W x 55"L

Retail Price
~~\$2605⁹⁹~~

PRICE REDUCTION NOW ONLY
\$699⁹⁵

Amber only
Other colors available at
\$79⁰⁰ extra

| LED COLOR | ITEM # |
|-----------|-------------------|
| | Amber LED-2600 |
| | Red LED-2605 |
| | Red/Blue LED-2607 |
| | Green LED-2608 |
| | Blue LED-2609 |



7 BUTTON CONTROL BOX



Replacement LED modules available in these colors:
A R B G C **\$29⁰⁰each** LEM-01
 Please specify color when ordering



27" STREAMLINED ULTRA MINI LED LIGHTBAR



US Patent No: D545, 230

Retail Price
~~\$895⁹⁹~~

PRICE REDUCTION NOW ONLY
\$299⁹⁵

Amber only
Other colors available at
\$29⁰⁰ extra

| LED COLOR | ITEM # |
|-----------|-------------------|
| | Amber LED-2055 |
| | Red LED-2056 |
| | Red/Blue LED-2057 |
| | Green LED-2058 |
| | Blue LED-2059 |

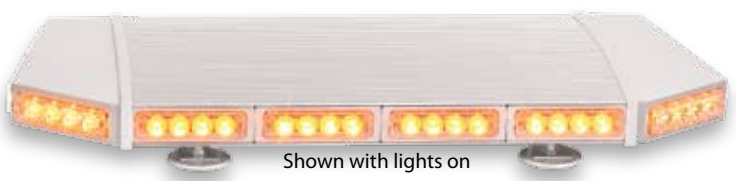

1" Shown with lights turned off

3 BUTTON CONTROL BOX



Replacement LED modules available in these colors:
A R B G C **\$29⁰⁰each** LEM 01
 Please specify color when ordering

- 14 High intensity LED modules
- Ultra slim profile and clear lens for stealth look
- Automatic alternating flash pattern
- 2 LED alley lights
- Includes magnetic mount and 3 button control box
- 1.78"H x 12"W x 27"L
- 12 foot power cord with cigarett adapter (12V DC)

Tel: (877) 643-1100 ---- Toll Free
Fax: (877) 700-4477 ---- Toll Free

(818) 341-1500 (US & NON US calls) PST
(818) 341-0015 (US & NON US calls) PST

Phone Ordering
M-F 7am - 5:30pm
Sat 9am - 2pm

61½" OPTI-RANGE STEALTH

Shown with lights off

Front View

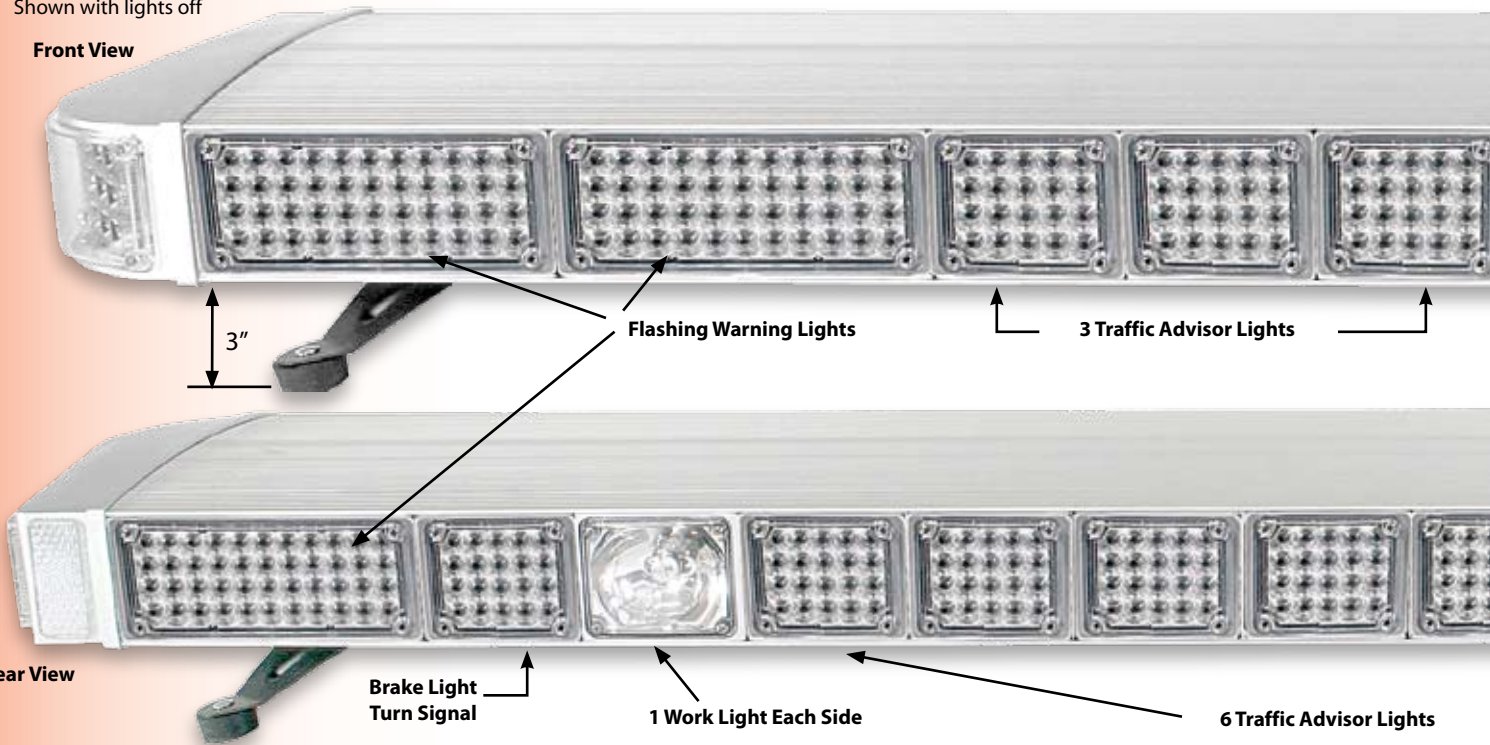

The Opti-Range series features clear lenses and clear LEDs to give an inconspicuous appearance when turned off. At the flick of a switch, the LEDs warn and illuminate with high intensity color light.

- 24 LED modules with 7 selectable flash patterns
- Built-in amber arrow stick
- 2 halogen take-down lights on front
- 2 halogen alley lights, each controlled independently
- Narrow side reflectors for increased visibility
- Aerodynamic design
- Hard anodized finish
- Universal mounting kit & 7 button control box
- 12 foot power cord
- Power: 12V DC

45" OPTI-RANGE STEALTH LED LIGHTBARS



7 BUTTON CONTROL BOX



Retail Price
~~\$899⁹⁹~~



Amber only
Other colors available at
\$49⁰⁰ extra

- 16 LED modules with 7 selectable flash patterns
- Built-in amber arrow stick
- 2 halogen take-down lights on front
- 2 halogen alley lights, each controlled independently
- Narrow side reflectors for increased visibility
- Aerodynamic design with hard anodized finish
- Includes universal mounting kit and 7 button control box
- Size: 3-1/2" H x 12" W x 45-1/2" L
- 12 foot power cord
- Power: 12V DC

| LED COLOR | ITEM # |
|-----------|-----------------|
| | Amber LED-65 |
| | Red LED-66 |
| | Red/Blue LED-67 |
| | Green LED-68 |
| | Blue LED-69 |

LED TOW TRUCK LIGHTBARS



WARNING LIGHTS



3 Traffic Advisor Lights

Flashing Warning Lights

Size: 3-1/2"H x 12"W x 61 1/2"L

Retail Price
~~\$729.99~~



Amber only
Other colors available at
\$49.00 extra



Includes 12 foot power cord

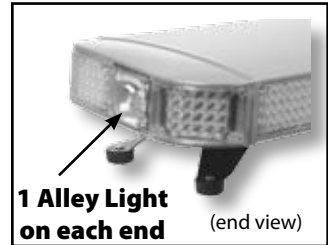

1 Alley Light on each end (end view)

7 BUTTON CONTROL BOX



| LED COLOR | ITEM # |
|-----------|-----------|
| | LEDTOW-65 |
| | LEDTOW-66 |
| | LEDTOW-67 |
| | LEDTOW-68 |
| | LEDTOW-69 |



22" OPTI-RANGE STEALTH MINI-LED LIGHTBAR



Shown with lights turned off

2 1/4"

- 8 LED modules with automatic alternating flash pattern
- Light is clear when off for a stealthy look
- 2 halogen alley lights, each side with separate controls
- 12 foot cord with cigarette adapter (12V DC)
- Steadfast magnetic mount
- Includes 3 button control box
- Size: 22 1/2"L x 12 1/2"W x 3 1/2"H

Retail Price
~~\$399.99~~



Amber only
Other colors available at
\$19.00 extra

| | |
|-----------------------------------------------------------------------------------------|-------------------------------------------------------------------------------------------------------------------------------------------|
| Replacement LED modules available in these colors: \$14.95 each LEM-03 | Replacement lenses available <input type="checkbox"/> Clear \$4.95 each LEM-01 Please specify front or side when ordering |
|-----------------------------------------------------------------------------------------|-------------------------------------------------------------------------------------------------------------------------------------------|

3 BUTTON CONTROL BOX



| LED COLOR | ITEM # |
|-----------|--------|
| | LED-55 |
| | LED-56 |
| | LED-57 |
| | LED-58 |
| | LED-59 |

Tel: (877) 643-1100 ---- Toll Free
Fax: (877) 700-4477 ---- Toll Free

(818) 341-1500 (US & NON US calls) PST
(818) 341-0015 (US & NON US calls) PST

Phone Ordering
M-F 7am - 5:30pm
Sat 9am - 2pm

60" COMBINATION STROBE-HALOG

FULL SIZE TOW

Shown with lights off

All strobe and halogen module colors are interchangeable.

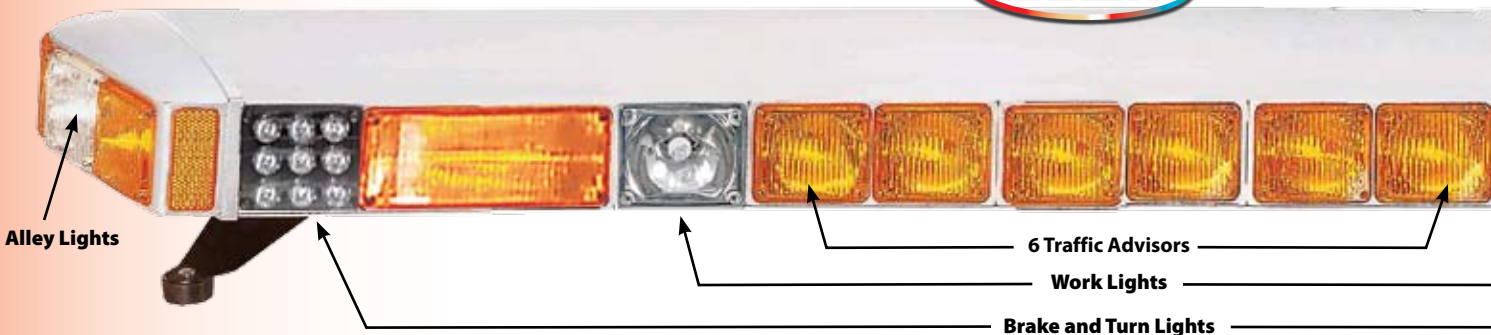
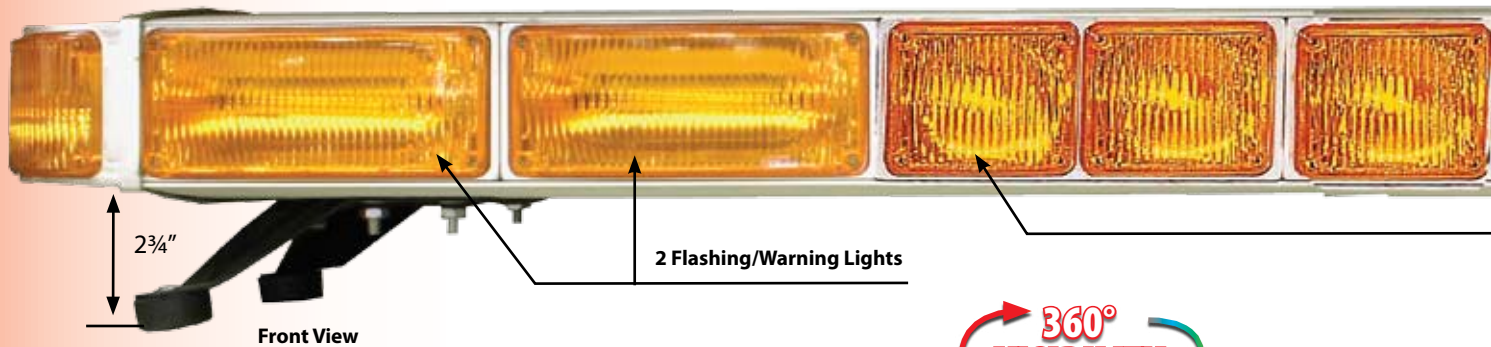

- Aerodynamic design with hard anodized finish
- 2 rear lights for instant workspace lighting
- Strobe lights on front and rear provides the ultimate in warning power
- GEN III LED brake lights on the rear
- 2 halogen alley lights and 2 halogen take down lights
- Alternating flash patterns
- Ideal for fire trucks, tow trucks and oversized vehicles
- Includes 12 foot power cord (12V DC), 5 button control box and universal mounting kit

45" COMBINATION STROBE-HALOGEN-G

Front view



Shown with lights off



Replacement strobe modules available
\$29⁹⁵ each STM-01

Replacement halogen lenses available in these colors:
\$4⁹⁵ each LEN-05
 Please specify color and front or corner when ordering



| LENS COLOR | ITEM # |
|------------|-----------|
| Amber | LBSTOW-90 |
| Blue | LBSTOW-94 |
| Green | LBSTOW-93 |
| Red | LBSTOW-91 |
| Red/Blue | LBSTOW-92 |

Call for specific module replacements

All strobe and halogen module colors are interchangeable.

GEN-III LED LIGHTBAR

TRUCK LIGHT BAR

Size: 60" x 4 1/2"H x 12"W



6 Traffic Advisors

2 Flashing/Warning Lights



Rear View

Alley Lights

Retail Price

~~\$1695⁹⁹~~



Amber only

Other colors available at \$49.00 extra

6 BUTTON CONTROL BOX



LENS COLOR ITEM #



Amber TLBS-190



Blue TLBS-194



Green TLBS-193



Red TLBS-191



Red/Blue TLBS-192

Replacement strobe modules available

\$19⁹⁵ each STM-01

Replacement halogen lenses available in these colors:

A R B G

\$4⁹⁵ each LEN-05

Please specify color and front or corner when ordering

Call for specific module replacements

GEN-III LED LIGHTBAR

Back view



Shown with lights off

Work Lights

Brake and Turn Lights

Size: 3 1/2"H x 12"W x 45 1/2"W

- Ideal for tow trucks and oversized vehicles
- Aerodynamic design with hard anodized finish
- 2 rear lights for instant workspace lighting
- Directional halogen traffic system on front and rear of lightbar for additional visibility
- Strobe lights on front and rear provides the ultimate in warning power
- GEN III LED brake lights on the rear
- Alternating flash patterns
- Includes a 12 foot power cord
- Power: 12V DC
- Includes 6 button control box and universal mounting kit

6 BUTTON CONTROL BOX



Retail Price

~~\$1495⁹⁹~~



Amber only

Other colors available at \$49.00 extra

Tel: (877) 643-1100 ---- Toll Free
 Fax: (877) 700-4477 ---- Toll Free

(818) 341-1500 (US & NON US calls) PST
 (818) 341-0015 (US & NON US calls) PST

Phone Ordering
 M-F 7am - 5:30pm
 Sat 9am - 2pm

62" OPTI-RANGE STEALTH

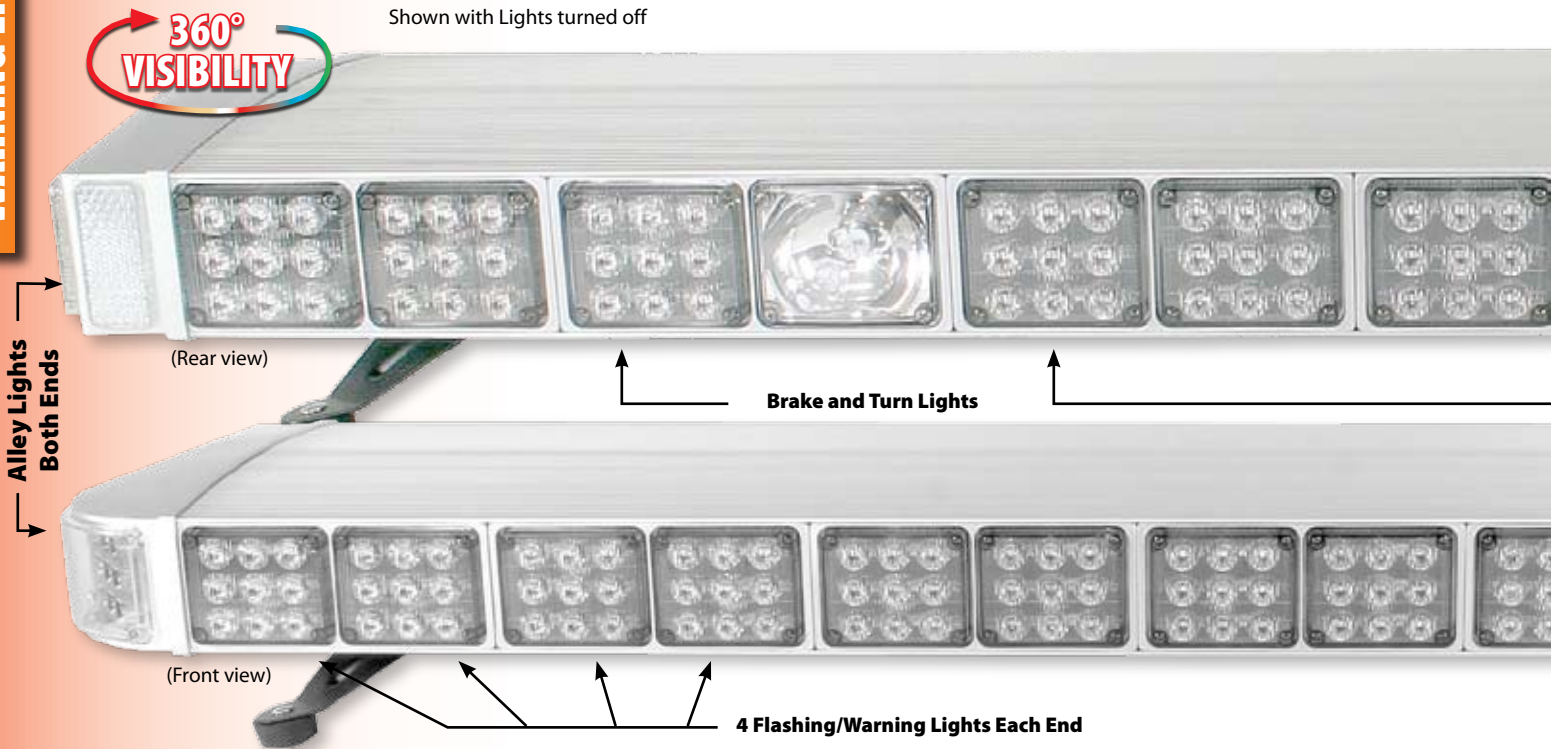

- Ideal for tow trucks, fire trucks and oversized vehicles
- 30 of the brightest LEDs on the market
- 7 selectable flash patterns
- Aerodynamic design with hard anodized finish
- 2 rear lights for instant workspace lighting
- Directional traffic system on the front and rear activates

- three warning patterns (left, right and center flashing)
- Includes 7 button control box, permanent universal mounting kit
- Includes 12 foot power cord
- Power: 12V DC

45" OPTI-RANGE STEALTH ULTRA LIGHTBARS

Size: 45½" x 4½"H x 12"W

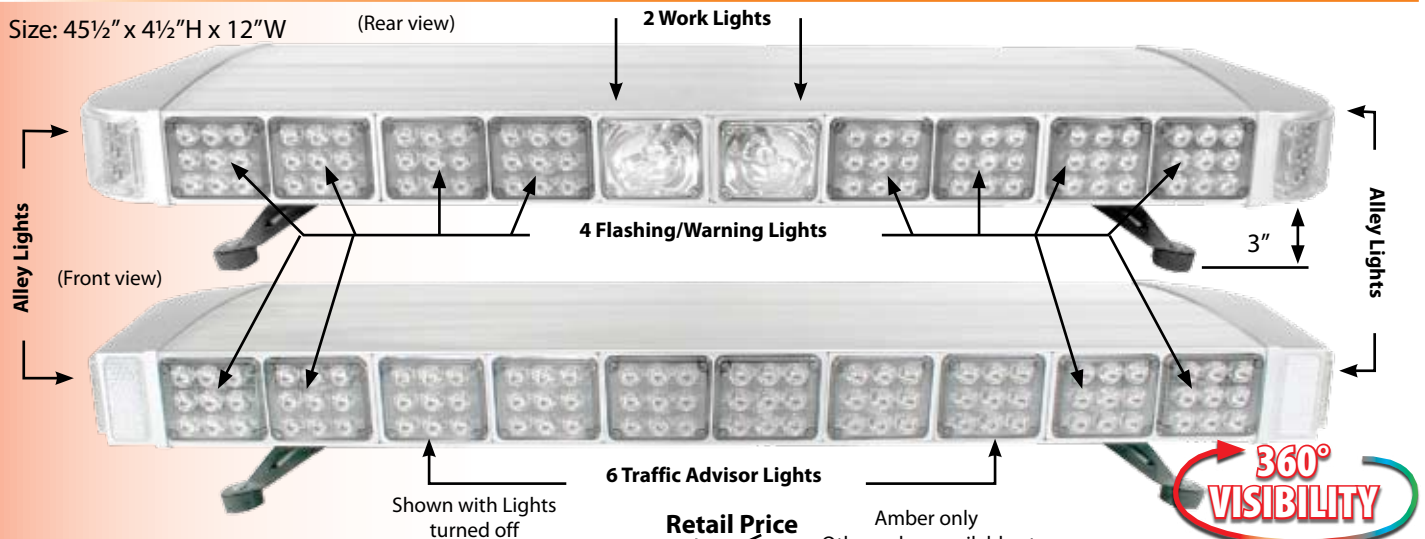

- 22 of the brightest LEDs on the market
- 7 selectable flash patterns
- Aerodynamic design with hard anodized finish
- 2 steady alley lights, 1 each side with separate controls
- Directional traffic system on rear only
- Includes 7 button control box, universal mounting kit and 12ft cord • Power: 12V DC

Retail Price ~~\$2049⁹⁹~~
PRICE REDUCTION NOW ONLY
\$599⁹⁵

Amber only
 Other colors available at
\$39.00 extra

| LED COLOR | ITEM # |
|-----------|------------------|
| | Amber LED-165 |
| | Blue LED-169 |
| | Red LED-166 |
| | Red/Blue LED-167 |

Replacement modules: LEM-05
 Indicate color on order.

62" ULTRA LED LIGHTBAR

Size: 62" x 4 1/2" H x 12" W



WARNING LIGHTS



6 Traffic Advisor on front and back

Work Lights



3"



(end view)

Retail Price

~~\$794⁹⁹~~



Amber only
Other colors available at
\$59.00 extra

7 BUTTON CONTROL BOX



| LED COLOR | LENS COLOR | ITEM # |
|-----------|------------|---------|
| | Clear | LED-265 |
| | Clear | LED-266 |
| | Clear | LED-267 |
| | Clear | LED-268 |

22" OPTI-RANGE STEALTH ULTRA MINI LED LIGHTBAR WITH TAKE DOWN LIGHTS

- 10 LED modules with automatic alternating flash pattern
- 2 front mounted halogen take down lights
- Light is clear when off for a stealthy look
- 1 halogen alley light on each side with separate controls
- 12 foot cord with cigarette adapter (12V DC)
- Steadfast magnetic mount
- Includes 3 button control box
- Size: 22 1/2" L x 12 1/2" W x 3 1/2" H

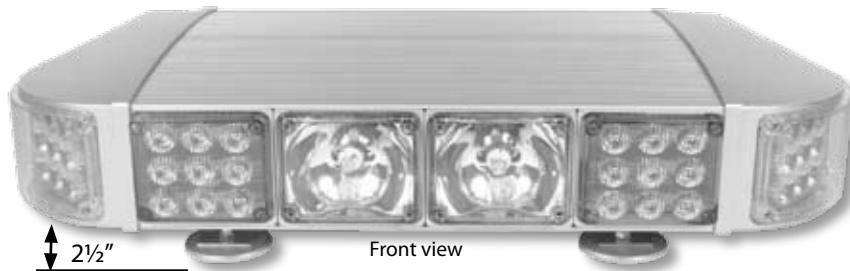

2 1/2"

Front view

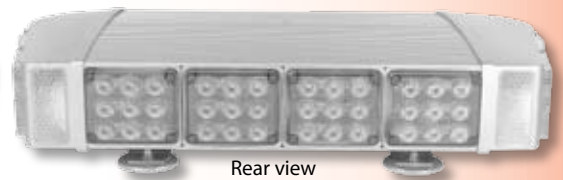

Rear view

Lights shown turned off

Retail Price

~~\$1389⁹⁹~~



Amber only

Other colors available at
\$49.00 extra

| LED COLOR | LENS COLOR | ITEM # |
|-----------|------------|---------|
| | Clear | LED-150 |
| | Clear | LED-154 |
| | Clear | LED-153 |
| | Clear | LED-151 |
| | Clear | LED-152 |

Replacement LED lenses available in these colors:

A R B G C

\$29⁹⁵ each LEM-05

Specify front, corner or rear

Replacement halogen lenses available in these colors:

A R B G C

\$4⁹⁵ each LEN-05

Please specify color and front or corner when ordering

Call for specific module replacements

Tel: (877) 643-1100 ---- Toll Free
Fax: (877) 700-4477 ---- Toll Free

(818) 341-1500 (US & NON US calls) PST
(818) 341-0015 (US & NON US calls) PST

Phone Ordering
M-F 7am - 5:30pm
Sat 9am - 2pm

101

45" OPTI-RANGE

Front View



Retail Price
~~\$899⁹⁹~~



Amber only
Other colors available at
\$39.00 extra

- 16 LED modules with 7 selectable flash patterns
- Built-in amber arrowstick
- 2 halogen take-down lights on front
- 2 halogen alley lights, each controlled independently
- 12 foot power cable

Rear View

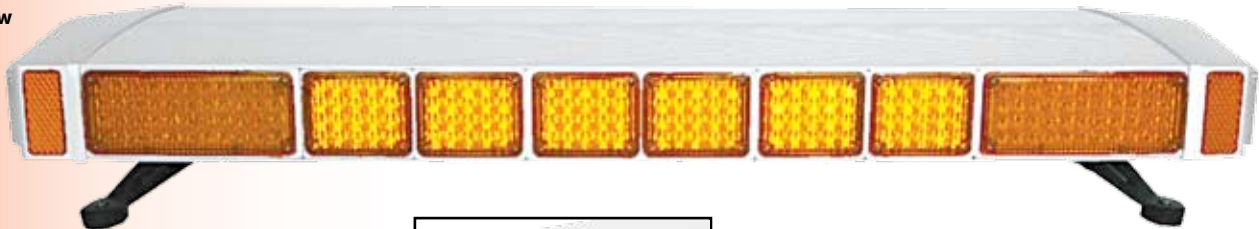

7 BUTTON CONTROL BOX



| LENS COLOR | ITEM # |
|------------|-----------------|
| | Amber LED-60 |
| | Blue LED-63 |
| | Green LED-64 |
| | Red LED-62 |
| | Red/Blue LED-61 |

22" OPTI-RANGE LED LIGHTBAR

Lights turned off



- 8 LED modules with alternating flash pattern
- 2 halogen alley lights, each side with separate control
- 12 foot cord with cigarette adapter
- Steadfast magnetic mount
- Includes 3 button control box
- Size: 22 1/2"L x 12 1/2"W x 3 1/2"H



3 BUTTON CONTROL BOX



Retail Price
~~\$399⁹⁹~~



Amber only
Other colors available at
\$19.00 extra

| LED COLOR | ITEM # |
|-----------|-----------------|
| | Amber LED-50 |
| | Red LED-53 |
| | Red/Blue LED-52 |
| | Green LED-51 |
| | Blue LED-54 |

Replacement lenses available in these colors:

A R B G
\$4⁹⁵ each
LEN-01

Replacement LED modules available in these colors:

Clear
\$29⁹⁵ each **LEM-03**
Please specify front or side when ordering

LED LIGHTBAR

**360°
VISIBILITY**

WARNING LIGHTS



- Narrow side reflectors for increased visibility
- Aerodynamic design with hard anodized finish
- Includes universal mounting kit and 7 button control box
- Size: 3-1/2"H x 12"W x 45 1/2"L
- Power: 12V DC

**EVERYDAY
LOW PRICES**

**360°
VISIBILITY**

45" OPTI-RANGE LED LIGHTBAR WITH SPEAKER & SIREN



2 3/4"

- 16 LED modules with 7 selectable flash patterns
- Built-in amber arrowstick
- Narrow side reflectors for increased visibility
- Front mounted 100 watt speaker
- Aerodynamic design with hard anodized finish
- Includes universal mounting kit and 7 button control box and 6 function siren
- 12 foot power cable
- Power: 12V DC
- Size: 3-1/2"H x 12"W x 45-1/2"L

Retail Price
~~\$999.99~~
PRICE REDUCTION NOW ONLY
\$399.95

Amber only
Other colors available at
\$39.00 extra

**7 BUTTON
CONTROL BOX**



**LENS
COLOR** **ITEM #**

| | | |
|--|----------|----------------|
| | Amber | LED-160 |
| | Blue | LED-161 |
| | Green | LED-162 |
| | Red | LED-163 |
| | Red/Blue | LED-164 |

OPTI-RANGE SERIES REPLACEMENT PARTS

UNIVERSAL MOUNTING KIT



| Replacement LED modules | | Replacement lenses | | |
|-------------------------|-----------------|--------------------|-----------------|-----------------|
| SQUARE & CORNER | RECTANGLE | SQUARE | RECTANGLE | CORNER |
| LEM-03 A | LEM-04 A | LEN-01 A | LEN-02 A | LEN-03 A |
| LEM-03 R | LEM-04 R | LEN-01 R | LEN-02 R | LEN-03 R |
| LEM-03 B | LEM-04 B | LEN-01 B | LEN-02 B | LEN-03 B |
| LEM-03 G | LEM-04 G | LEN-01 G | LEN-02 G | LEN-03 G |
| LEM-03 C | LEM-04 C | LEN-01 C | LEN-02 C | LEN-03 C |
| \$29.95 each | | \$4.95 each | | |

7 BUTTON CONTROL BOX



3 BUTTON CONTROL BOX



**NEW
ITEM**

Tel: (877) 643-1100 ---- Toll Free
Fax: (877) 700-4477 ---- Toll Free

(818) 341-1500 (US & NON US calls) PST
(818) 341-0015 (US & NON US calls) PST

Phone Ordering
M-F 7am - 5:30pm
Sat 9am - 2pm

THE BRIGHTEST LIGHTS ON THE MARKET

46" OPTI-RANGE STROBE LIGHTBARS

Features strobe lights in the front, halogen traffic advisors on the rear and additional strobe lights on each side.

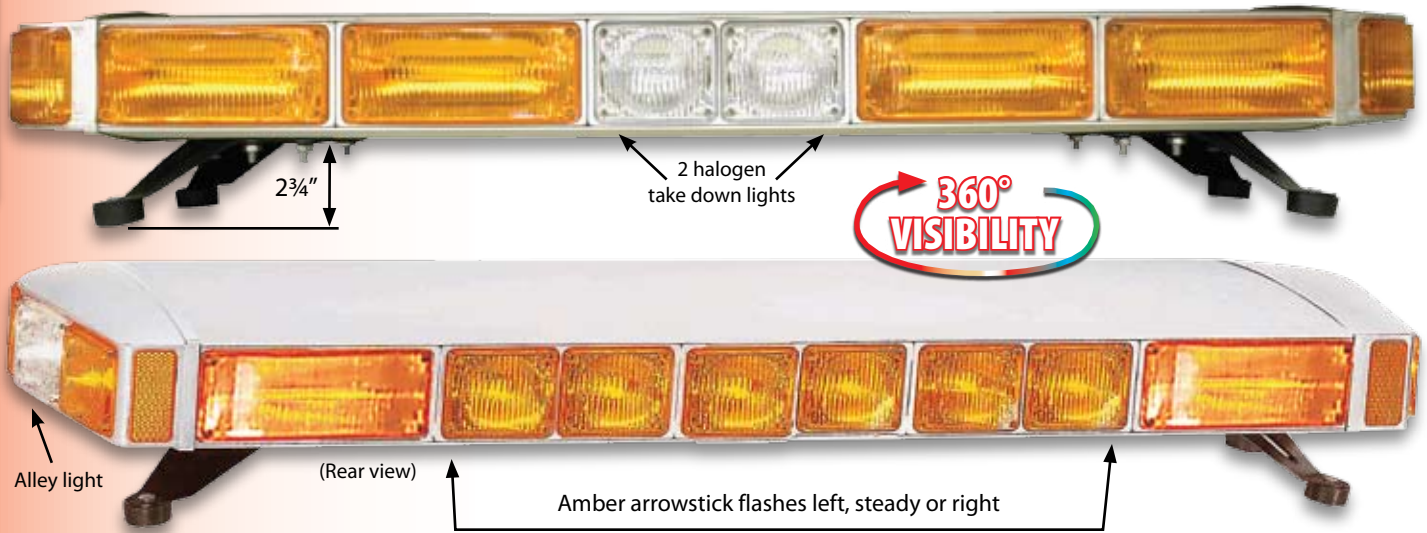

- Strobe light for maximum warning power
- 2 halogen take-down lights and 2 alley lights
- Halogen arrowstick in the back
- Aerodynamic design with anodized finish
- Includes 6 button control box, 12 foot cord and universal mounting kit
- Size: 45 1/2" L x 12" W x 30 1/2" H
- Rapid quad flash pattern
- Power: 12V DC

Retail Price
~~\$1299⁹⁹~~

PRICE REDUCTION NOW ONLY
\$399⁹⁵

Amber only
Other colors available at
\$39⁰⁰ extra

6 BUTTON CONTROL BOX



| LENS COLOR | ITEM # |
|------------|------------------------|
| | Amber LBS-90 |
| | Blue LBS-94 |
| | Green LBS-96 |
| | Red LBS-92 |
| | Red/Blue LBS-91 |

Replacement lenses available in these colors:

A R B G C
\$4⁹⁵ each LEN-04

Specify front, corner or rear

22" OPTI-RANGE MINI STROBE LIGHTBARS

Retail Price
~~\$499⁹⁹~~

PRICE REDUCTION NOW ONLY
\$199⁹⁵

Amber only
Other colors available at
\$29⁰⁰ extra

- Strobe lights in the front, rear and sides for maximum warning power
- Rapid quad flash pattern
- 12 foot cord with cigarette adapter
- Steadfast magnetic mount

- 2 halogen alley lights, each controlled independently
- Includes 3 button control box
- Size: 22 1/2" L x 12 1/2" W x 3 1/2" H
- Power: 12V DC



Replacement strobe modules available:

\$29⁹⁵ each STM-01

Replacement lenses available in these colors

A R B G
\$4⁹⁵ each LEN-04

Please specify color and front, corner or side when ordering

INCLUDED HARDWARE

3 BUTTON CONTROL BOX



THE BRIGHTEST LIGHTS ON THE MARKET

OPTI-RANGE HALOGEN LIGHTBAR

WARNING LIGHTS

These lightbars feature halogen lights in the front, complimented by halogen arrowstick on the back with additional halogen lights on each side



2 halogen take down lights

Alley light

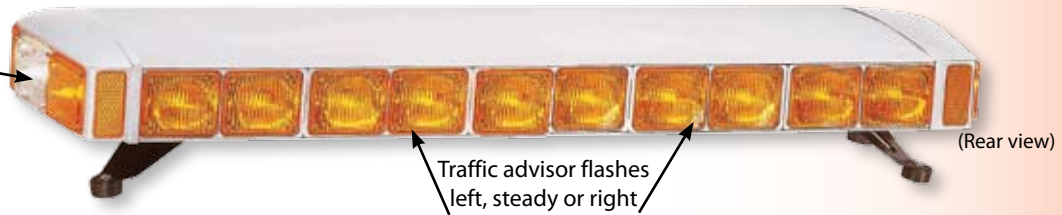

(Rear view)

Traffic advisor flashes left, steady or right

INCLUDED HARDWARE

UNIVERSAL MOUNTING KIT



6 BUTTON CONTROL BOX



- Automatic alternating flash pattern
- 2 halogen take-down lights and 2 alley lights
- Traffic advisor in the back
- Builtin amber arrowstick
- Power: 12V DC

- Aerodynamic design with anodized finish
- Includes 6 button control box, 12 foot cord and universal mounting kit
- Size: 45 1/2" L x 12"W x 3 1/2"H

LENS COLOR

| LENS COLOR | ITEM # |
|------------|-----------------|
| | Amber LBH-60 |
| | Red LBH-62 |
| | Red/Blue LBH-64 |
| | Green LBH-66 |
| | Blue LBH-63 |

Replacement lenses available in these colors:



\$4⁹⁵ each
LEN-05

Please specify color and front or corner when ordering

Retail Price

~~\$469⁹⁹~~



Amber only
Other colors available at **\$39.⁰⁰ extra**

22" OPTI-RANGE MINI HALOGEN LIGHTBARS

- Rapidly alternating halogen flashers in the front and rear for maximum visibility
- 12 foot cord with cigarette lighter adapter
- Steadfast magnetic mount

- 2 alley lights, each controlled independently
- Includes 3 button control box
- Size: 22 1/2"L x 12 1/2"W x 3 1/2"H
- Power: 12V DC



LBH-52

2 1/4"



LBH-76



LBH-74



LBH-75



LBH-77

Retail Price

~~\$299⁹⁹~~



Amber only
Other colors available at **\$29.⁰⁰ extra**

Replacement lenses available in these colors



\$4⁹⁵ each LEN-02

Please specify color and front, corner or side when ordering

INCLUDED HARDWARE

3 BUTTON CONTROL BOX



Tel: (877) 643-1100 ---- Toll Free
Fax: (877) 700-4477 ---- Toll Free

(818) 341-1500 (US & NON US calls) PST
(818) 341-0015 (US & NON US calls) PST

Phone Ordering
M-F 7am - 5:30pm
Sat 9am - 2pm

105

STREAMLINED ULTRA SLIM ARROWSTICKS

- High intensity LED modules
- Ultra slim profile for an aerodynamic look
- Includes universal mounting kit
- 5 button control box
 - On/Off
 - Steady flash
 - Right and Left direction
 - 7 selectable flash patterns
- 12 foot long power cord
- Mounts adjustable to span different 3rd brake light heights
- Internal use only
- Amber color only



\$239⁹⁵
LED-210-B



\$199⁹⁵
LED-250-B

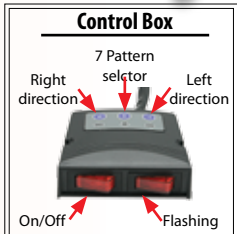

\$179⁹⁵
LED-220B

UNITS WITH 3 OR 4 MODULES ARE FLASHERS ONLY

- Ultra slim profile
- 7 selectable flash patterns
- Simple On/Off switch
- 1 button pattern selection switch
- Universal mounting kit
- Internal use only
- Amber color only



\$129⁹⁵
LED-230-B



\$109⁹⁵
LED-240-B

All lights shown turned off



STREAMLINED CUSTOMIZABLE SLIM ARROWSTICKS

- High intensity LED modules
- Slim profile for an aerodynamic look
- Includes universal mounting kit
- 5 button control box (On/Off, Flashing, Right direction, Left direction and pattern selector)
- 12 foot long power cord
- Mounts adjustable to span different heights
- For internal or external use
- Power: 12V DC
- Each module is available in Amber, Blue, Green, Red and White upon requests



All lights shown turned off



\$239⁹⁵
LED-210-S



\$199⁹⁵
LED-250-S



\$179⁹⁵
LED-220-S

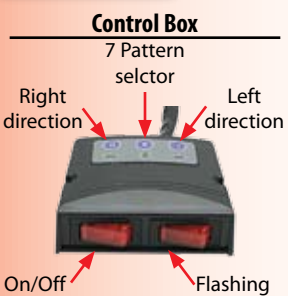

\$159⁹⁵
LED-260-S

UNITS WITH 3, 4 or 5 MODULES ARE FLASHERS ONLY

- Ultra slim profile
- 7 selectable flash patterns
- 1 button pattern selection switch
- Universal mounting kit
- Internal and external use
- Each module is available in Amber, Blue, Green, Red or White upon request



\$129⁹⁵
LED-230-S



\$109⁹⁵
LED-240-S

Replacement LED modules available in these colors:

A R B G C **\$29.00** each **LEM-01**
Please specify color when ordering

each

47" STREAMLINED ULTRA ARROWSTICK



Retail Price ~~\$499⁹⁹~~
PRICE REDUCTION NOW ONLY
\$199⁹⁵

Amber only
 Other colors available at **\$29.00 extra**

| LED COLOR | LENS COLOR | ITEM # |
|-----------|------------|---------|
| | Clear | LED-205 |
| | Clear | LED-206 |
| | Clear | LED-207 |



- High intensity LED modules
- Durable, rugged construction
- End warning LED modules
- Includes standard bolt mount
- Six array LED modules with 3 automatic flash patterns: left, right and warning-flash
- 3 button control box
- 12-foot cord with in line fuse connects directly to the battery
- Size: 1 3/4"H x 2"W x 47"L
- For vehicle interior use only
- Power: 12V DC

Replacement LED modules available in these colors: **\$19.00 each**
 LEM-06 **A** LEM-06 **R** LEM-06 **B** LEM-06 **G**



STREAMLINED ULTRA DASH AND DECK LIGHTS

- High intensity LED modules
- 15 selectable flash patterns
- Includes hood, universal swivel bracket, 3 suction cups and cigarette plug with on/off switch

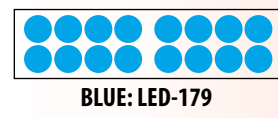
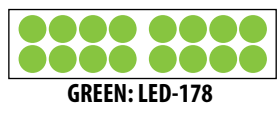
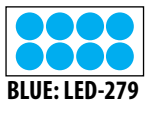
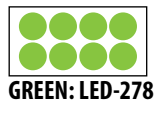
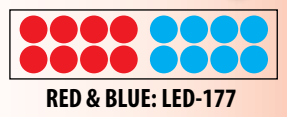
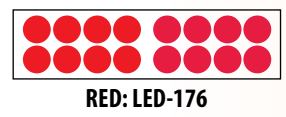

Mix and match LED colors to customize unit for your use by special request only!

Replacement LED modules available in these colors: **\$19.00 each**
 LEM-06 **A** LEM-06 **R** LEM-06 **B** LEM-06 **G**



Tel: (877) 643-1100 ---- Toll Free
 Fax: (877) 700-4477 ---- Toll Free

(818) 341-1500 (US & NON US calls) PST
 (818) 341-0015 (US & NON US calls) PST

Phone Ordering
 M-F 7am - 5:30pm
 Sat 9am - 2pm

48" HUSKY HALOGEN ROTATING LIGHTBARS

- 5 halogen rotators with speed of 130 FPM
- 2 take-down lights and 2 alley lights
- Additional lower flashing lights on front and back for increased visibility

- Includes 5 button control box, 12 foot cord and universal mounting kit
- Size: 48"L x 7"H x 12"W
- Power: 12V DC



Retail Price
~~\$499⁹⁹~~



Amber only
Other colors available at
\$39.⁰⁰ extra



Retail Price
~~\$499⁹⁹~~



Amber only
Other colors available at
\$39.⁰⁰ extra



INCLUDED HARDWARE

UNIVERSAL MOUNTING KIT

5 BUTTON CONTROL BOX

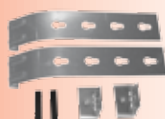

Replacement domes available in these colors:



\$19⁹⁵ each
DOM-02

Replacement large filters available in these colors:



\$9⁹⁵ each
LFL-01

Replacement end lenses available in these colors:



\$4⁹⁵ each
LEN-03

Please specify color when ordering

48" HUSKY HALOGEN ROTATING LIGHTBARS WITH SPEAKER COMPARTMENT

- 4 halogen rotators with speed of 130 FPM
- 2 alley lights and additional lower flashing lights on front and back for increased visibility
- Speaker compartment
- Includes 4 button control box, 12 foot cord and universal mounting kit
- Size: 48"L x 7"H x 12"W



Retail Price ~~\$499⁹⁹~~
PRICE REDUCTION NOW ONLY
\$239⁹⁵
 Amber only
 Other colors available at **\$39⁰⁰ extra**

INCLUDED HARDWARE

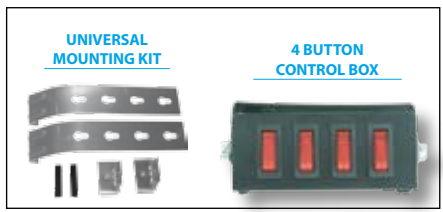

Replacement domes available in these colors:



\$19⁹⁵ each
 DOM-02

Replacement large filters available in these colors:



\$9⁹⁵ each
 LFL-01

Please specify color when ordering

Replacement end lenses available in these colors:

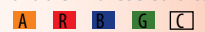

\$4⁹⁵ each
 LEN-03

Tel: (877) 643-1100 ---- Toll Free
Fax: (877) 700-4477 ---- Toll Free

(818) 341-1500 (US & NON US calls) PST
(818) 341-0015 (US & NON US calls) PST

Phone Ordering
 M-F 7am - 5:30pm
 Sat 9am - 2pm

44" HALOGEN ROTATING LIGHTBARS WITH SPEAKER COMPARTMENT

- 6 halogen rotators • 2 alley lights, each controlled independently
- Includes 3 button control box, 12 foot cord and universal mounting kit

- Speaker compartment for compact speaker (not included)
- Size: 44"L x 12"W x 6"H
- Power: 12V DC

Retail Price

~~\$499⁹⁹~~



\$199⁹⁵

Amber only
Other colors available at
\$39.⁰⁰ extra



LBH-20



LBH-28



LBH-26



LBH-22

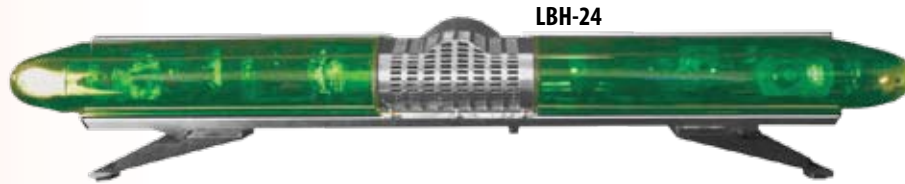

LBH-24

INCLUDED HARDWARE

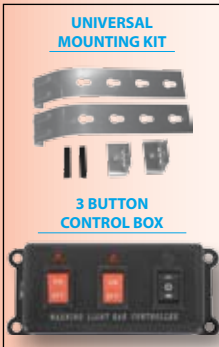

UNIVERSAL MOUNTING KIT

3 BUTTON CONTROL BOX

Replacement domes available in these colors:



\$19⁹⁵ each
DOM-04

Replacement filters available in these colors:



\$9⁹⁵ each
LFL-01

Please specify color when ordering

24" MINI HALOGEN ROTATING LIGHTBARS

Retail Price
~~\$149⁹⁹~~



Amber only
Other colors available at
\$19.⁰⁰ extra

- 2 halogen rotators with speed of 130 RPM
- Steadfast magnetic mount
- Includes a 9 ft cord with cigarette plug

- Size: 24"L x 5"H x 12"W
- One touch switch
- Power: 12V DC



LBH-03



LBH-04



LBH-02



LBH-05



LBH-01

Replacement domes available in these colors:



\$14⁹⁵ each
DOM-05

Replacement filters available in these colors:



\$9⁹⁵ each
LFL-02

Please specify color when ordering

FLASHING TEARDROP BEACONS

This incandescent light is perfect for command or volunteer vehicles. Also great for golf carts.

Specifications:

- 130 rotations per minute for maximum visibility
- Magnetic attachment
- 11-foot cord plugs right into cigarette lighter
- 6" H x 5" W x 7" L/20 Watt Bulb
- One touch switch

Retail Price ~~\$39⁹⁵~~



Amber only
Other colors available at \$9⁰⁰ extra



SINGLE FLASHING STROBE BEACONS

- Strobe lights flash 80 times per minute
 - Sturdy magnetic mount
 - Dimensions: 3 1/2" x 4 1/2"
 - 12-foot cord plugs into cigarette lighter
 - Protective adaptor fuse built-in
- Applications:** Fire Trucks, Police Automobiles, Ambulances Security Vehicles, Peace Officer Vehicles



DOUBLE FLASHING STROBE BEACONS

- Strobe lights flash 80 times per minute
- Sturdy magnetic mount
- Dimensions: 4.6" x 5.8"
- 12-foot cord conveniently plugs into cigarette lighter
- Protective adaptor fuse built-in
- Multi-flash for maximum visibility



Retail Price ~~\$39⁹⁵~~



Amber only Other colors available at \$9⁰⁰ extra



Retail Price ~~\$85⁹⁵~~

TWIN BEAM ROTATING BEACON

- 360° rotating beacon offers high visibility
- Sturdy magnetic mount
- 12-foot cord plugs into cigarette lighter
- Features an in line fuse to protect your
- 130 RPM
- One touch switch

Dimensions 9" x 6 1/2"

Retail Price ~~\$129⁹⁹~~



Amber only
Other colors available at \$9⁰⁰ extra



UAW LED WARNING LIGHTS

Compact LEDs with long life and efficient power usage



WL-03
Blue



WL-04
Amber



WL-06
Red



WL-02
Red



WL-05
Blue

3 1/4" H x 3 3/4" W x 2 1/2" D

Retail Price

~~\$99⁹⁹~~



per pair

Replacement lenses available in these colors:

A **R** **B** **G** **□** **\$4⁹⁵** each LEN-01

Please specify color when ordering



INCLUDES:

POWER SUPPLY AND LIGHT CONTROLLER

12 V DC power supply can be used to control a pair of warning lights

UAW STROBE WARNING LIGHTS

Wide dispersion strobe lights for extreme warning power



WL-07
Amber



WL-08
Blue



WL-09
Red

3 "H x 5 3/4" W x 2 3/4" D

Retail Price

~~\$216⁹⁹~~



per pair



INCLUDES:

POWER SUPPLY AND LIGHT CONTROLLER

12 V DC power supply can be used to control a pair of warning lights

SIREN SPEAKER & SIREN MEGAPHONE

- Six-tone siren (air-horn, wail, etc..) and megaphone
- Public address option
- Available in 80W & 100W



5 1/8"W x 1 3/4"H x 6"D

- 80 Watt:**
LB-35 Speaker: \$59.95
LB-36 Siren: \$59.95
LB-37 Siren Speaker Set: \$99.95

- Black ABS plastic and metal construction
- Allows mounting behind the grille or in bumper
- Available in 80W & 100W



Sturdy permanent mount

7 1/4"W x 4 1/2"H x 6 1/2"D

- 100 Watt:**
LB-135 Speaker: \$69.95
LB-136 Siren: \$69.95
LB-137 Siren Speaker Set: \$119.95

**HIGH PERFORMANCE,
 SPACE SAVING
 SPEAKERS AT
 INCREDIBLE PRICES**

COMPACT 100 WATT SPEAKER



- 100 Watts
- Non-corrosive finish
- Compact size: 6"H x 6"W x 3"D
- Includes bracket

\$79.95
S-100

SPACE-SAVING 80W SPEAKER



- Less than 2" deep!
- Corrosion-resistant black finish
- 80W of power
- Weight: 4 lbs
- Includes a universal bracket that fits most vehicles
- 3 7/8"H x 4 1/2"W x 1 7/8"D

\$59.95
S-102

SPACE-SAVING 100W SPEAKER



- Only 2" deep!
- Corrosion-resistant metal finish
- 100W of power
- Weight: 5 lbs
- Includes a universal bracket that fits most vehicles
- Size: 4 1/2"H x 5 1/8"W x 2"D

\$69.95
S-101

ADVANCED HIDEAWAY STROBE LIGHTS

80 WATT STROBE SET

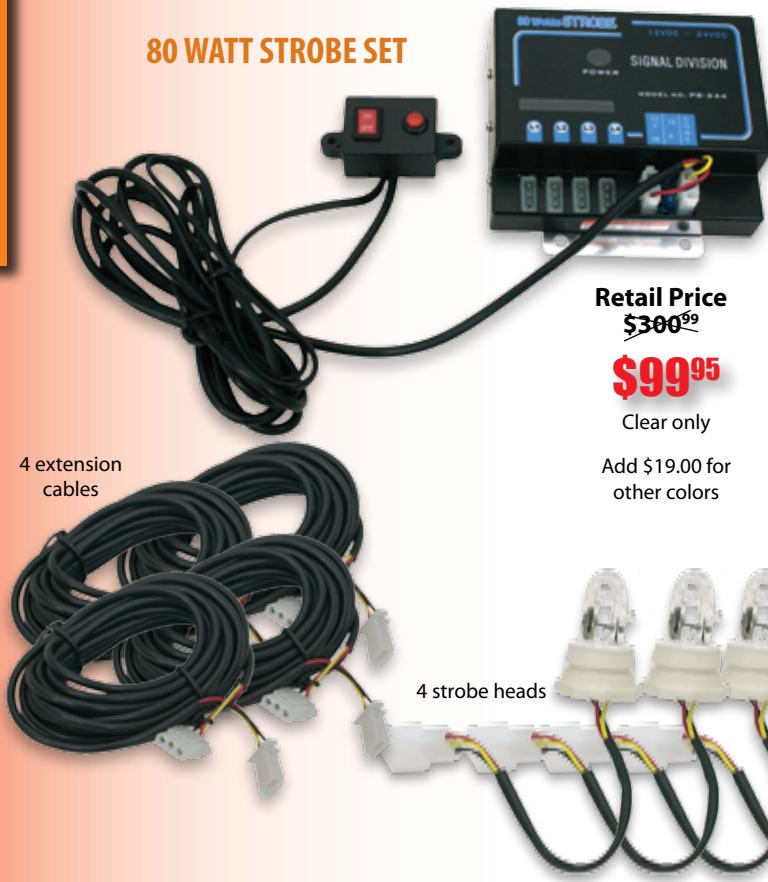

Retail Price
~~\$300⁹⁹~~
\$99⁹⁵

Clear only
Add \$19.00 for other colors

80 watt strobe set includes:

- 1 - connection box
 - 1 - 6 foot power cord with
 - 1 - On/Off switch
 - 1 - button flash pattern selector with 4 selectable patterns
 - 4 - strobe heads
 - 2 - 10 foot extension cables
 - 2 - 15 foot extension cables
- Working voltage: 12V DC

Set available in these colors



Clear Strobe Replacement Bulbs

\$19⁹⁵

1" H
1 1/2" H

BB-11C Clear bulb only BB-11R Red bulb only
BB-11B Blue bulb only

UAW HIDEAWAY STROBE LIGHTS

2 STROBE SET

Retail Price
~~\$299⁹⁹~~
\$99⁹⁵

- Includes 2 or 4 coiled strobes mountable in front or rear of vehicle
- Provides instant warning when needed
- Includes power cord and switch (8 feet extension cable and 6 feet switch cable)

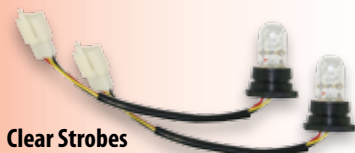
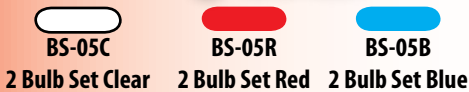
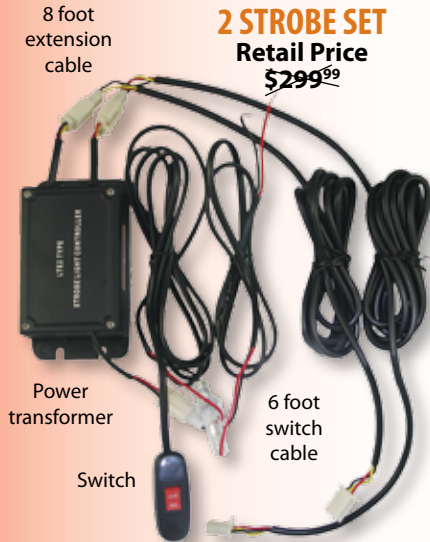

PRICE REDUCTION NOW ONLY
\$59⁹⁵

Clear only
Add \$19.00 for other colors

Clear Strobe Replacement Bulbs

\$19⁹⁵

1" H
1 1/2" H

BB-11C Clear bulb only
BB-11R Red bulb only
BB-11B Blue bulb only

4 STROBE SET

Retail Price
~~\$299⁹⁹~~
\$99⁹⁵

PRICE REDUCTION NOW ONLY
\$99⁹⁵

Clear only
Add \$19.00 for other colors

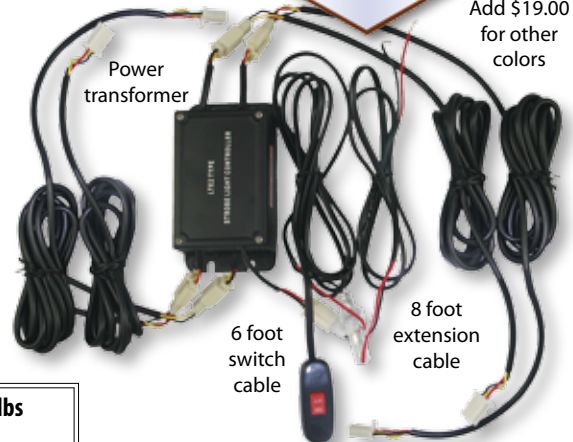

STREAMLINED ULTRA LED LIGHT

- High intensity LEDs
- Durable housing protects against moisture and vibration
- 15 selectable flash patterns
- Easy to mount
- Fits on grilles



Our Price **\$49⁹⁵**



VANGUARD 3000 LED LIGHTS

- New GEN 3 LEDs provide excellent warning power
- 15 Selectable flash patterns
- Durable housing protects against vibration and moisture
- Includes 6 foot power cord
- Mounting kit adjust up and down and tilts



\$69⁹⁵

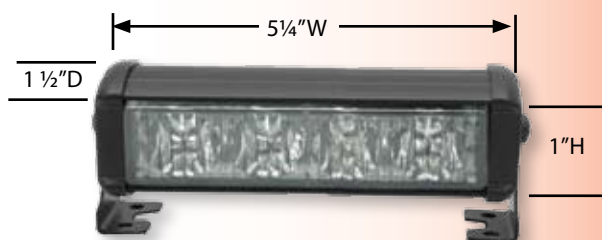

\$59⁹⁵



See our web site for videos showing the flash patterns and brightness of many of our lightbars!

We accept purchase orders from government institutions, corporations, universities and other companies upon credit approval.

ALWAYS

- **HIGH QUALITY**
- **FAST DELIVERY**
- **GREAT SERVICE**



Tel: (877) 643-1100 ---- Toll Free
 Fax: (877) 700-4477 ---- Toll Free

(818) 341-1500 (US & NON US calls) PST
 (818) 341-0015 (US & NON US calls) PST

Phone Ordering
 M-F 7am - 5:30pm
 Sat 9am - 2pm

HANDHELD SPEAKER

Includes handheld speaker component with coiled cord.

7½" diameter
13½" length
Takes 6 D-cell batteries



\$29⁹⁵

LB-33

RECHARGEABLE SPOT LIGHTS

- Includes swivel mount & portable power pack.
- Charge by car battery or with home adapter (included)
- 1.5 million candle power quartz halogen spotlight
- Built-in 6V/4AH rechargeable battery
- Weather-proof & impact resistant
- Momentary trigger switch lock
- Replaceable battery & bulb



\$9⁹⁵

FL-09

Also available 6 Volt 4AH-20HR batteries made specially for this product for \$4.95 (BVB-05)

LIGHT-WEIGHT WARNING WAND

- Off, flashing and steady light switch
- Non-slip grip handle
- Built-in belt and wrist strap



Takes 2 "C" batteries.
Total length 21"

TB-01

\$9⁹⁵



Takes 2 "C" batteries.
Total length 15"

TB-02

\$8⁹⁵

125 METER POLICE BARRIER TAPE

Mixture of yellow, white & red for the highest visibility.

PT-32

\$19⁹⁵



HANDHELD STOP SIGN

- Flashing red light on one side, bright stop sign on the other
- Ideal for school functions, community events, fairs and concerts
- A necessity for security personnel, traffic directors & crossing guards
- Takes 3 "C" batteries



\$9⁹⁵

LB-34

WARNING TRIANGLE

Driving manuals suggest individuals carry a suitable warning triangle for use during breakdowns. For maximum visibility our fluorescent warning triangle includes a hanging Exclamation Point (!), increasing its reflective mass. Collapsing for easy storage, the triangle quickly unfolds for immediate use on its sturdy metal cross bow stand.



\$5⁹⁵

LB-31

DAR CLIPBOARD

Essential for law enforcement & security personnel:

- Internal compartments: 1" depth standard bottom compartment and small ½" top compartment
- Wide top clip & additional small clip
- Built-in pen & pencil compartment
- Non-reflective hard aluminum
- Lightweight
- Dimensions: 9¼" W x 14" L

\$9⁹⁵

CB-07



COLLAPSIBLE SAFETY CONES



Size: Height 21" Base: 12" x 12"

\$16⁹⁵ CONE-07



Size: Height 18" Base: 9½" x 9½"

\$11⁹⁵ CONE-01

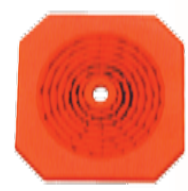

Size: Height 15" Base: 9½" x 9½"

\$9⁹⁵ CONE-02



- Highly visible
- Lightweight and easily carried
- Stores in a small space
- Made of waterproof cloth and ABS
- Collapsible height: 2"

REFLECTIVE ORANGE SAFETY CONES

- Highly visible bright red-orange for maximum visibility
- Reflective tape surfaces to increase visibility
- Fade resistant in all weather conditions
- Base designed for easy stacking without sticking
- Made of one continuous layer of PVC



Height 18"
Base: 11½" x 11½"

\$7⁹⁵ each
CONE-03



Height 28"
Base: 13¾" x 13¾"

\$15⁹⁵ each
CONE-04



Height 36"
Base: 14½" x 14½"

\$24⁹⁵ each
CONE-05

REFLECTIVE PORTABLE BOLLARDS

- Highly visible bright red-orange for maximum visibility
- Reflective tape surfaces to increase visibility
- Fade resistant in all weather conditions
- Keyhole slot on both sides to attach rope or chain (not included)
- Used for all road safety, maintenance and repair conditions
- Made of one continuous layer of P.E.



4½" round post
43" tall

\$14⁹⁵ Each
CONE-06

Base: 16"



3¾" to 8¾"
tapered post
43" tall

\$16⁹⁵ Each
CONE-08

Base: 18"

WALL AND COLUMN PROTECTORS

- Highly visible bright yellow & black for maximum visibility
- Fade resistant in all weather conditions
- Easy to install



COLUMN PROTECTORS

WALL PROTECTORS



Made of 1" thick Rubber
Size: 32" tall

\$14⁹⁵ each

PRK-01



Made of ¾" thick Rubber
Size: 32" tall

\$12⁹⁵ each

PRK-02

LED TRAFFIC BARRICADE LIGHT



- Highly visible bright yellow
- Visible to 550 yards
- Flashing starts automatically at dark and stops at daybreak
- Flash rate 60 per minute
- Includes 6V battery(4R25)
- Battery life 600 hours

\$9⁹⁵ each

BAR-01

BARRICADE LED LIGHTS



- Highly visible bright orange
- Visible to 550 yards
- Flash rate 60 per minute
- Battery powered
- Battery life 500 hours
- Requires 2 AA batteries (not included)

\$9⁹⁵ each

Orange: BAR-02



- Highly visible bright orange
- Visible to 550 yards
- Flash rate 60 per minute
- Includes 6V battery (4R25)
- Battery life: 600 hours

\$19⁹⁵ each

BAR-03

Each ankored by 2 1/2" dia bolts

MODULAR RUBBER SPEED BUMP SYSTEM

- Made of compression molded composite, synthetic and natural rubber
- Highly resistant to weathering and extreme temperatures (-22°F to 140°F)
- Finishing is black or yellow rubber composite

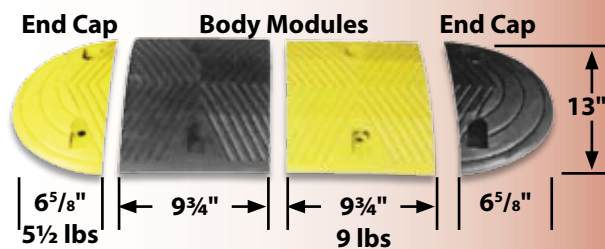

All modules are 2" Thick

DIFFERENT COMBINATION EXAMPLES

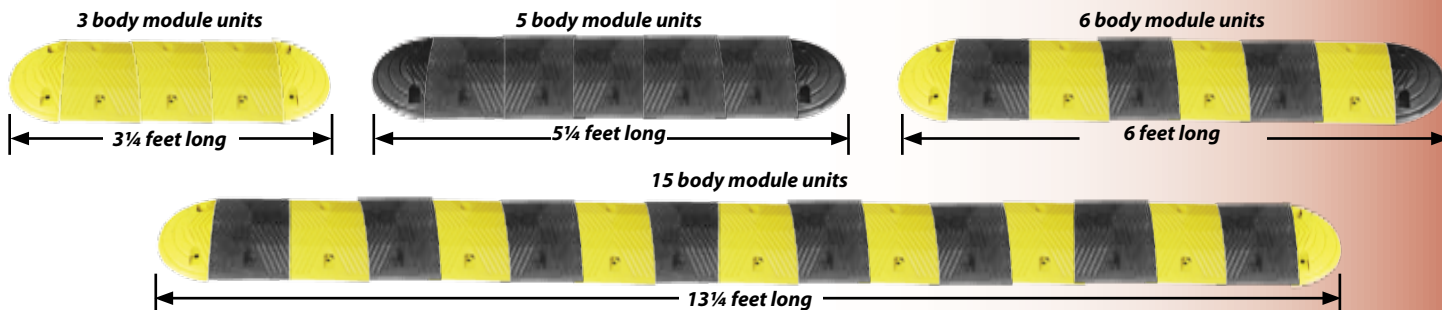

Individual units

| MODULE | BLACK | YELLOW | OUR PRICE |
|--------|-------|--------|---------------|
| ENDS | SB-02 | SB-03 | \$7.95 |

| MODULE | BLACK | YELLOW | OUR PRICE |
|--------|-------|--------|---------------|
| CUBES | SB-04 | SB-05 | \$9.95 |

COMBO UNITS: Just select the length you need and locate the number of modules you will require.

These lengths are when using stated number of center body modules and 2 end caps.

| Body Modules | 2 | 3 | 4 | 5 | 6 | 7 | 8 | 9 | 10 | 11 | 12 | 13 | 14 | 15 |
|--------------|--------------|--------------|--------------|--------------|----------|--------------|--------------|--------------|--------------|-----------|---------------|---------------|---------------|---------------|
| Total Length | 2 3/4 | 3 1/2 | 4 1/4 | 5 1/4 | 6 | 6 3/4 | 7 1/2 | 8 1/2 | 9 1/4 | 10 | 10 3/4 | 11 3/4 | 12 1/2 | 13 1/4 |

Additional lengths available on request. Call for quote.

BARRIER TAPE

- Weather resistant vinyl
- Caution tapes are highly visible bright yellow background with black text
- Danger tapes is black text on a red background
- 2" easy to read letters

Custom caution tape has a minimum order of 100 rolls at \$9⁹⁵ each. The delivery time is approximately 10 weeks.

Call and ask for our art department about ordering. Law enforcement items require proof of occupation.



| SIZE | TEXT | ITEM # | Price |
|-------------------------|-----------------------------------|------------|---------------|
| 3" X 1,000 YARDS | CAUTION | TAP-01 | \$8.95 |
| | DANGER | TAP-02 | \$8.95 |
| | DO NOT ENTER | TAP-03 | \$8.95 |
| | FIRE LINE DO NOT CROSS | TAP-04 | \$8.95 |
| | CRIME SCENE DO NOT CROSS | TAP-05 | \$8.95 |
| | NO PARKING | TAP-06 | \$8.95 |
| | SHERIFF LINE DO NOT CROSS | TAP-07 | \$8.95 |
| | YOUR CUSTOM TEXT ON RED | TAPCUST-10 | \$9.95 |
| | YOUR CUSTOM TEXT ON YELLOW | TAPCUST-20 | \$9.95 |

Tel: (877) 643-1100 ---- Toll Free
Fax: (877) 700-4477 ---- Toll Free

(818) 341-1500 (US & NON US calls) PST Phone Ordering
(818) 341-0015 (US & NON US calls) PST M-F 7am - 5:30pm
 Sat 9am - 2pm

REFLECTIVE SECURITY VESTS



SV-10: Orange without ID
 SV-29: Green without ID
 SV-28: Red without ID

ONE SIZE
 FITS ALL

Retail
 \$12.95



SV-15: Red

SV-17: Green

SV-11: Orange with ID

REFLECTIVE DUTY VESTS



Back View

Durable midnight blue mesh construction with fluorescent trim and reflective silver stripes.

Includes mic clip, pen pocket and inside pocket

Adjustable
 Velcro® Sides



SV-09: Plain

SV-12: Security

SV-13: Sheriff

SV-14: Traffic Control

SV-16: Police

\$19.95

Sizes: Small - 5XL

*Police and Sheriff vests require proof of occupation.

REFLECTIVE SAFETY VESTS



Back View

Reflective lime green vests ensures high visibility in all traffic conditions.

ONE SIZE
 FITS ALL

\$9.95



SV-18: Plain

SV-19: Security

SV-20: Traffic Control

SV-07: Safety

SV-08: Parking

REFLECTIVE EMERGENCY VESTS

ONE SIZE FITS ALL

Reflective orange vests ensure high visibility in all conditions.

Retail \$12⁹⁵

PRICE REDUCTION NOW ONLY \$9⁹⁵



SV-21



SV-22



SV-23



SV-24



SV-25



SV-26



SV-27



SV-30

NOW IN ESPAÑOL

Call and ask about having any of our reflective vests custom made for your company!

ALWAYS

- HIGH QUALITY
- FAST DELIVERY
- GREAT SERVICE

EVERYDAY LOW PRICES

We accept purchase orders from government institutions, corporations, universities and other companies upon credit approval.

Tel: (877) 643-1100 ---- Toll Free
Fax: (877) 700-4477 ---- Toll Free

(818) 341-1500 (US & NON US calls) PST
(818) 341-0015 (US & NON US calls) PST

Phone Ordering
M-F 7am - 5:30pm
Sat 9am - 2pm



COMMERCIAL PROGRAMMABLE UHF 2-WAY TRANSCEIVER

Heavy duty commercial programmable UHF system incorporates the latest advanced technology. The radio comes pre-programmed and can be reprogrammed to your specification by purchasing the programming cable and downloading the free software from our web site. 15 channels plus one scanning channel. Comes with antenna, wrist loop, belt clip, battery, charger, and adaptor.

Standard Specifications:

- Frequency: 450-470 Mhz
- RF Power: 4W, Range: 2 to 3 miles
- Built in tone signaling - CTCSS
- Compatible with most 2 prong Kenwood headsets & accessories

BATTERY RECHARGING STATION

- This recharging station will recharge up to 6 UA-01 or UA-100/200 radios (shown on following page) at the same time
- Indicator LED changes color when radio is completely charged
- Simply plugs into any standard 110 volt outlet



COMPARE AT \$269⁹⁵



UA-01



Battery



Charger

Also available as replacement parts

| | |
|--------------------------|---------|
| Charger: UAC-01 | \$19.95 |
| Battery: Bat-100 | \$19.95 |
| Battery: UA-WB | \$19.95 |
| Programming cable: UAW-C | \$9.95 |
| Radio software : UAW-S | \$9.95* |



\$79⁹⁵

UAC-06

*For a CD version or download from our web site for free

RADIO HOLDERS



SYNTHETIC LEATHER
\$9⁹⁵
SL-11



BASKET WEAVE LEATHER
\$9⁹⁵
L-11



PLAIN LEATHER
\$9⁹⁵
P-11



BASKET WEAVE LEATHER
\$9⁹⁵ L-26

UNIVERSAL NYLON
\$9⁹⁵ N-26

SYNTHETIC LEATHER
\$9⁹⁵ SL-26



NYLON
\$9⁹⁵ N-25

COMMERCIAL PROGRAMMABLE UHF/VHF 2-WAY RADIO

Designed for heavy duty use. The radio comes pre-programmed and can be reprogrammed to your specification by purchasing the programming cable and downloading the free software from our web site. Includes 1500 mAh battery, desktop charger, antenna and belt clip.

Specifications:

- Frequency: 450-470 Mhz(UHF), 150-174Mhz(VHF)
- Compatible with most 2 prong Kenwood headsets & accessories
- 16 channels
- Built in tone signaling - CTCSS/DTCSS
- Range: 2 to 3 miles
- RF Power: 5watts



Charger Unit



Battery

Also available as replacement parts

| | |
|---------------------------------|----------------|
| Charger: UAC-01 | \$19.95 |
| Battery: BAT-100 | \$19.95 |
| Programming cable: UAW-C | \$9.95 |
| Radio software: UAW-S | \$9.95* |

**For a CD version or download from our web site for free*



UHF UA-100
VHF UA-200
Retail \$259⁹⁵
\$69⁹⁵ each

RADIO SPEAKER MICROPHONES

LIGHTWEIGHT REMOTE SPEAKER MIC

- Strain relief cable for maximum durability
- 360° swivel clip • 3.5mm accessory jack
- Fits most 2 prong Kenwood radios UA-18
- Fits most 2 prong Motorola radios UA-19

\$10⁹⁵ each



HEAVY DUTY REMOTE MICROPHONE

- Strain relief cable for maximum durability
- 360° swivel clip • 3.5mm accessory jack
- Fits most 2 prong Kenwood radios UA-16
- Fits most 2 prong Motorola radios UA-17

\$19⁹⁵ each

HEADSET ADAPTORS

Adapter allows you to use 2 prong Motorola earphones on Motorola radios with different jacks.

Fits Motorola radios:

- HT750, HT1250, HT1500XLS,
- MTX8250LS, MTX950,
- MTX9250, EX500, EX600,
- GL200, GP140, GP320, GP340,
- GP344, GP380, GP388,
- GP640, GP680, GP1280,
- PRO5150, PRO7150



\$10⁹⁵ each

UA-20

Fits Motorola radios:

- HT1000, MT2000, MTS2000,
- MTX838, MTX9000, MTX-
- LS, XTS2500, XTS3000,
- XTS3500 and XTS5000 and
- EF Johnson radios



\$19⁹⁵ each

UA-21



Tel: (877) 643-1100 ---- Toll Free
Fax: (877) 700-4477 ---- Toll Free

(818) 341-1500 (US & NON US calls) PST
(818) 341-0015 (US & NON US calls) PST

Phone Ordering
M-F 7am - 5:30pm
Sat 9am - 2pm

RADIO HEADSETS

EARPHONE WITH BOOM MICROPHONE

- Adjustable earphone with flexible boom arm microphone
- In-line PTT button with clothing clip

\$10⁹⁵



Fits most 2-prong Kenwood radios **UA-04**
 Fits most 2-prong Motorola radios **UA-22**

SURVEILLANCE EARPHONE WITH LAPEL MICROPHONE

- Discreet lapel microphone with built-in push-to-talk (PTT) button
- Surveillance style clear tube earphone
- Lightweight, durable and highly concealable

\$10⁹⁵



Fits most 2-prong Kenwood radios **UA-05**

EARPHONE WITH LAPEL MICROPHONE

- Discreet lapel microphone with built-in push-to-talk (PTT) button

\$10⁹⁵



Fits most 2-prong Kenwood radios **UA-02**
 Fits most 2-prong Motorola radios **UA-23**

EARPHONE WITH LAPEL MICROPHONE

- Discreet lapel microphone with built-in push-to-talk (PTT) button
- Rugged polyurethane cable for maximum durability

\$9⁹⁵



Fits most 2 prong Kenwood radios **UA-06**
 Fits most 2 prong Motorola radios **UA-07**

D-LOOP EARPHONE WITH BOOM MICROPHONE

- D-loop earphone with flexible boom arm microphone
- Discreet lapel microphone with built-in push-to-talk (PTT) button
- Rugged polyurethane cable for maximum durability

\$10⁹⁵



Fits most 2 prong Kenwood radios **UA-08**
 Fits most 2 prong Motorola radios **UA-09**

LISTEN ONLY SURVEILLANCE EARPIECE

- Surveillance style clear tube earphone
- Works with remote speaker microphones
- 3.5mm plug

\$10⁹⁵



Fits most remote speakers with 3.5mm accessory jack **UA-10**

3-WIRE SURVEILLANCE EARPIECE

- Includes earphone, microphone and barrel PTT (push-to-talk) remote
- Surveillance style clear earphones
- Can be worn on lapel or sleeve
- Clip provides cable retention cut strain on earphone

\$19⁹⁵



Fits most 2 prong Kenwood radios **UA-11**
 Fits most 2 prong Motorola radios **UA-12**

HEADSET WITH BOOM MICROPHONE

- Includes headset, boom microphone and in-line PTT button with clothing clip.

\$9⁹⁵



Fits most 2 prong Kenwood radios **UA-03**

D-LOOP EARPHONE WITH LAPEL MICROPHONE

- D-loop earphone can be worn on either right or left ear
- Discreet lapel microphone with built-in push-to-talk (PTT) button
- Rugged polyurethane cable for maximum durability

\$9⁹⁵



Fits most 2 prong Kenwood radios **UA-14**
 Fits most 2 prong Motorola radios **UA-15**



ENFORCER CLASSIC

CONCEALABLE BODY ARMOR BY US ARMOR

If you want the finest concealable vest for the dollar, this is it. The Enforcer™ is an everyday concealable vest that sets new standards for high performance at an affordable price. It's made with fourth-generation Kevlar® that's softer, lighter, thinner and more flexible than ever.

- Complies with NIJ 2005 interim requirements
- Removable Poly-Cotton/Intera™ vest carrier
- Air-entangled Dupont Kevlar 129® with stainless steel 6" x 8" trauma plates
- Dupont Nylon Supplex 3-ply panel cover
- 6-point elastic and Velcro® (removable)
- Color: Navy Blue
- Stab proof

ARC-01 & Arc-02 include a stainless steel (hard) 6" x 8" trauma plate.



Available in chest sizes with regular vest lengths:

(short and long lengths and 4XL size available on special order)

- Small (34-36)
- Medium (38 - 40)
- Large (42 - 44)
- 1XL (46 - 48)
- 2XL (50 - 52)
- 3XL (54 - 56)
- 4XL (58-60)



ENFORCER CLASSIC BODY ARMOR LEVEL II

\$399⁹⁵ ARC-01

Sizes available: Small - 3XL
For 2XL add 10%, for 3XL add 15%
for 4XL add 20%

ENFORCER CLASSIC BODY ARMOR LEVEL IIIA

\$499⁹⁵ ARC-02

Proof of occupation required for this purchase.

| BALLISTIC CAPABILITIES | II | IIIA |
|------------------------|----------|----------|
| 9mm (124g FMJ RN) | 1617 fps | 1617 fps |
| 40 S+W (155g FMJ) | - | - |
| .357 mag (158g JSP) | 1583 fps | - |
| .44 mag (240g JHP) | - | 1567 fps |

You must check your own state for laws and regulations on body armor usage.



ENFORCER XLT

CONCEALABLE BODY ARMOR BY US ARMOR

No longer do you have to sacrifice comfort for dependable DuPont™ KEVLAR® performance. The incredible Enforcer™ XLT Series from U.S. Armor is at least 25% lighter and more flexible than current all-Aramid fabric armor designs and still delivers V-50 ratings far in excess of NIJ requirements. Comfort, flexibility, high performance and dependable history, all in one quality Enforcer™ XLT Concealable Armor package.

- Complies with NIJ 2005 interim requirements
- KEVLAR® Comfort XLT, the latest ballistic technology from DuPont™, the most recognized producer of ballistic fiber advancements in the world.
- 6 point elastic and Velcro® (removable) and 4-point "Wide Wrap" both included
- Soft 6" x 8" Trauma Plate • Stab proof
- Premium poly-cotton/aquadyne carrier system • Color: Navy Blue

ARX-01 & ARX-02 include a 6" x 8" (soft) trauma plate.



ENFORCER XLT BODY ARMOR LEVEL II
\$649⁹⁵ ARX-01

Sizes available: Small - 3XL
For 2XL add 10%, for 3XL add 15%
for 4XL add 20%

ENFORCER XLT BODY ARMOR LEVEL IIIA
\$699⁹⁵ ARX-02

Sizes available: Small - 3XL
For 2XL add 10%, for 3XL add 15%
for 4XL add 20%

| BALLISTIC CAPABILITIES | II | IIIA |
|------------------------|----------|----------|
| 9mm (124g FMJ RN) | 1689 fps | 1749 fps |
| 40 S+W (155g FMJ) | 1613 fps | 1692 fps |
| .357 mag (158g JSP) | 1618 fps | 1752 fps |
| .44 mag (240g JHP) | - | 1587 fps |
| 7.62 x 25 (85g FMJ) | - | 1585 fps |

Available in chest sizes with regular vest lengths:
(short and long lengths and 4XL size available on special order)

- Small (34-36)
- Medium (38 - 40)
- Large (42 - 44)
- 1XL (46 - 48)
- 2XL (50 - 52)
- 3XL (54 - 56)
- 4XL (58-60)

You must check your own state for laws and regulations on body armor usage.

Proof of occupation required for this purchase.

Tel: (877) 643-1100 ---- Toll Free
Fax: (877) 700-4477 ---- Toll Free

(818) 341-1500 (US & NON US calls) PST
(818) 341-0015 (US & NON US calls) PST

Phone Ordering
M-F 7am - 5:30pm
Sat 9am - 2pm



LIBERATOR BODY ARMOR

CONCEALABLE BODY ARMOR BY FIRSTCLASS

The Liberator Body Armor is for those who demand uncompromised performance and comfort. Utilizing DuPont Kevlar for incredible performance and dependability, the Liberator Series is 30% lighter than current all-Aramid fabric armor, providing an excellent combination of flexibility and comfort. The front, back as well as the sides of the body have protection from firearms.

Specifications:

- Ballistic material: KEVLAR · Ballistic technology: DuPont · Protection Level: IIIA
- 6 point elastic and 4 point-point wide wrap with Velcro · Poly-cotton/aquadyne carrier system · Soft 6" x 8" Trauma Plate · Color: Black

Available in chest sizes with regular vest lengths:

- Small (34-36) · 2XL (50-52)
- Medium (38-40) · 3XL (54-56)
- Large (42-44) · 4XL (58-60)
- 1XL (46-48)



For Ballistic Capabilities of this body armor, please visit our web site at www.uniforms4all.com

You must check your own state for laws and regulations on body armor usage.

\$299⁹⁵
ARFC-01

Sizes available: Small - 4XL
For 2XL add 10%
for 3XL add 15%
for 4XL add 20%

Proof of occupation must be supplied with your order.

CUSTOM BADGE PACKAGE



50 BADGES



50 LAPEL PINS

\$27⁹⁵ PER SET
BNTL-01



50 NAME TAGS



50 TIE CLIPS



SUPER ALKALINE BATTERIES



AAA size battery

Item#: BAT-08

99¢
Set of 4



AA size battery

Item#: BAT-09

99¢
Set of 4



C size battery

Item#: BAT-10

99¢
Each



D size battery

Item#: BAT-11

99¢
Each

REPLACEMENT BATTERIES



AA size battery

BAT-02
\$.99



D size battery

BAT-01
\$1.49



9 Volt size battery

BAT-03
\$3.95



Lithium

BAT-04
\$1.95



BAT-100
\$19.95
Fits only
UA-100/UA-200



UA-WB
\$19.95
Fits only
UA-01

Radios pictured on pages 122-123



BAT-1014
\$19.95

Use with Guardscan
GS1000

Fits most Streamlight
model flashlights



BAT-07
\$9.95

Use with the FLD-21 flashlights
pictured on pages 7



FLB-05
\$12.95



Use with the FL-04 flashlights on pages 8 and
Rechargeable Maglite FL-32 on page 9



BAT-05
\$12.95

Use with the FL-30 flashlight
pictured on pages 7



BAT-13
\$9.95

TAILORING AVAILABLE

TAILORING SERVICES

Tailoring Fees:

- Hemming: \$3.95 per pants
- Collar tacking: \$1.00 per shirt
- Pant color striping: \$6.95 per pants
- * No Minimum Order for tailored items

Call for details and scheduling.

Tailoring Per Emblem:

- Shirt: \$.85 per emblem, or \$1.25 per emblem with more than 4 angles, such as star patches
- Jacket: \$1.50 per emblem, or \$2.00 per emblem with more than 4 angles
- Hat: \$1.50 per emblem, or \$2.00 per emblem with more than 4 angles



EMBROIDERY SERVICES



Call for details, scheduling and pricing.

We offer block or script lettering.

MINIMUM ORDER 1 DOZEN OF THE SAME ITEM

Digitizing Setup Fee- \$10.00 up to 3,000 stitches. \$10.00 more for every 1,000 stitches.

Embroidery: \$8.95 per hat, beanie, or caps.



| Stitches | Quantity | 12-35 | 36-71 | 72-99 | 100-999 | 1000+ |
|---------------|----------|--------|--------|--------|---------|--------|
| 0-5999 | | \$4.95 | \$3.95 | \$2.95 | \$1.50 | \$1.95 |
| 6000-8999 | | \$5.95 | \$4.95 | \$3.95 | \$2.50 | \$2.19 |
| 9000-12,999 | | \$6.95 | \$5.95 | \$4.95 | \$3.50 | \$2.95 |
| 13,000-14,999 | | \$7.95 | \$6.95 | \$5.95 | \$4.50 | \$3.50 |
| 15,000-19000 | | \$8.95 | \$7.95 | \$6.95 | \$4.95 | \$4.50 |

SILK SCREEN SERVICES



Add your company name, officer rank and name, or customized identifications on HATS, SHIRTS, and JACKETS.

MINIMUM ORDER: 1 dozen (12) of the same items

LOW-PRICE ONE-TIME SET-UP FEE - \$50.00
(Black, White and Gold Only)

Initial color free; 75¢ each additional color.

Size available:

Front: up to 3" H x 5" W

Back: up to 6" H x 12" W

*These prices are for 1 color. Add 75¢ to each imprint for additional colors.

*Proof of occupation is required for any law enforcement text.

| Location | Quantity* | 12-24 | 25-50 | 51-100 | 100-300 | 300-1,000 |
|------------------|-----------|--------|--------|--------|---------|-----------|
| Front/Chest Only | | \$5.95 | \$4.95 | \$3.95 | \$2.95 | \$1.95 |
| Back Only | | \$5.95 | \$4.95 | \$3.95 | \$2.95 | \$1.95 |
| Both | | \$9.95 | \$8.95 | \$5.95 | \$4.95 | \$2.95 |

INDEX

~B~

BADGES

Custom badges 63-68
 Stock badges 69-71
 Lapel Badges & Pins 72
 Miniature Size 73

BATONS

Baton holders
 Basket weave holders 61
 Nylon holders 61
 Plain leather holders 61
 Synthetic leather holders 61
 Expandable & holders 60, 61
 Fixed handle 60
 Plastic handle 60
 Spin handle 60

BATTERIES

Replacements 127

BODY ARMOR 125-126

~D~

DEFENSE SPRAYS

Pepper sprays
 Body guard LE-10 62
 MK3 & MK4 & MK6 62

DRESS UNIFORMS

Blazers 33
 Pants
 BDU tactical pants 36
 Elastique weave 34
 EMS pants 36
 Frontline motor breeches 38
 Khaki 35
 LAPD certified 37
 LA sheriff certified 37
 Pre-stripped 34
 Twill weave 35
 Uniform 33
 Shorts
 BDU 35
 Duty 35

DUTY GEAR

Basket weave gear
 Baton holders 51
 Belt combo set 51
 Belt combo set brass 53
 Duty belts 52
 Flashlight holders 52
 w/ brass fittings 53
 Gun holsters 52
 Hand cuff holder 51
 Cuff holder w/ brass fittings 53
 Keepers 52
 Keepers w/ brass fittings 53
 Key holders 52
 Key holder w/ brass fittings 53
 Magazine holders 52
 Mag holder w/ brass fittings 53
 Pepper spray holders 51

Spray holder w/ brass fittings 53
 Radio holder 51
 Carryall duty bag 57
 Gun holster
 Bianchi 58
 Leather badge wallets 59
 Multi tools 59
 Nylon gear
 Baton holders 56
 Belt combo set 56
 Belts 56
 Cuff holders 56
 Flashlight holders 56
 Gun holsters 56
 Keepers 56
 Key holders 56
 Magazine holders 56
 Pepper spray holders 56
 Radio holders 56
 Plain leather gear
 Badge holders 51, 54
 Baton holders 54
 Belt combo set 54
 Belts 55
 Cuff holder open 51
 Cuff holders 55
 Flash light holders 55
 Gun holsters 55
 ID holder 51
 Keepers 54
 Key holders 54
 Magazine holders 54
 Pepper spray holders 54
 Radio holders 54
 Wallets-ID badge holders 55, 59
 Synthetic leather gear
 Badge holder 50
 Baton holders 50
 Belt 49
 Belt combo set 49
 Cuff holders 49
 Flashlight holders 49
 Glove holders 50
 Gun holsters 50
 Keepers 49
 Key holders 50
 Magazine holders 50
 Pepper spray holders 49
 Radio holders 50

~E~

EMBLEMS

Custom designed emblems 79-81
 Large custom back emblems 77
 Large stock back emblems 77
 Stock designed emblems
 Cap 74
 Chest 74
 EMT 76
 Police & sheriff 74
 Rank 76
 Shoulder 74
 Tribute assortment 78
 US flags 75

EMERGENCY EQUIPMENT

Barricade light 118
 Barricade tape 119
 DAR clipboard 116
 Handheld speaker 116
 Handheld stop sign 116
 Handheld warning wand 116
 LED barricade light 118
 Police barrier tape 116
 Reflective bollards 117
 Safety cones - solid 117
 Spot light rechargeable 116
 Warning triangle 116

~F~

FLASHLIGHTS

Flashlights 8-12
 Flashlights - 2D & 3D cell 9
 Flashlight with stun gun 11
 LED flashlights
 6 LEDs 12
 6 LEDs & 1 xenon 9
 Head lamp 12
 Key chain compass 12
 Luxen rechargeable set 8
 Mini with cases 9
 Rechargeable set 9
 Maglite flashlights
 3 D-cell flashlights 10
 LED upgrade kit 11
 Maglite rechargeable system 10
 Mini Maglites 11
 Mini LED flashlight w/ multi tool 12

FLYING CROSS

All weather tropical shirts 40
 CHP men's uniforms 42
 Men's dress suit 33
 Polycotton shirts 40
 Polyester response wear 41
 Sheriff shirts 42
 Wool shirts & pants 41

FOOTWEAR

6" & 8" Strider boots 44
 6" & 8" Tactical boots 44-45
 8" All weather 44
 8" Tactical zipper boots 45
 Danner Arcadia tactical 45
 Dress shoes Condor brand 44
 Edge dressing 7
 Kiwi black polish 7
 Socks 45

~G~

GLOVES

Leather 45

GUARDSCAN 87-88

Patrol tour system 4

~H~

HAND CUFFS

Chain-linked 62
 Cuff key - key chain 62
 Easy cuffs 62

INDEX

| | |
|---------------------------|----|
| Hinged cuffs | 62 |
| Leg cuffs..... | 62 |
| Pearless 700 & 700P | 62 |

HEAD WEAR

| | |
|----------------------|----|
| Ball caps | 47 |
| Campaign hat | 48 |
| Masks & beanies..... | 47 |
| Service caps | 48 |
| Winter cap | 7 |



IDENTIFIERS

| | |
|------------------|----|
| Reflective | 23 |
|------------------|----|

INSIGNIAS

| | |
|--------------------------------|-------|
| Name tags - custom..... | 85-86 |
| Name tags - Serving Since..... | 86 |
| Rank & ID pins..... | 83-85 |
| US flag pins | 83 |



JACKETS

| | |
|--------------------------------------|-------|
| All season deluxe | 24-25 |
| All season jacket w/ ID | 23 |
| Elite windbreaker..... | 30 |
| Elite windbreaker ID | 30 |
| Elite windbreaker police ID | 31 |
| High visibility deluxe | 28 |
| High visibility windbreaker | 29 |
| Hoodie fleece zip | 7 |
| Leather bomber | 24 |
| Raincoat full length..... | 32 |
| Reflective jacket | 26 |
| Reversible rain gear | 27 |
| Tri-color | 27 |
| Watch-Guard bomber | 26 |
| Windbreaker police & sheriff ID..... | 31 |
| Windbreakers..... | 32 |



KNIVES

| | |
|---------------------|----|
| Folding knives..... | 46 |
|---------------------|----|



LAPEL PINS

| | |
|--------------------|----|
| Badges & pins..... | 72 |
|--------------------|----|

LOCKS

| | |
|-------------------|---|
| Key holders | 5 |
|-------------------|---|



MEASUREMENTS

| | |
|---------------------|-----|
| Sizing methods..... | 131 |
|---------------------|-----|

METAL DETECTORS

| | |
|-------------------------|----|
| Hand helds | |
| Compact..... | 91 |
| Garrett superwand | 91 |
| Walkthrough | |
| Garrett MT5500..... | 89 |
| Garrett PD6500I | 89 |
| WE002 | 90 |

N

NECK TIES

| | |
|----------------------------|----|
| Adjustable cross ties..... | 39 |
| Clip on break away..... | 39 |

NEW ITEMS

| | |
|-------------------------------|---------|
| 65/35 Polycotton shirt | 6 |
| 8" Danner tactical boots..... | 45 |
| Brown duty belt..... | 57 |
| Carryall duty bag | 6 |
| Custom badges | 66 |
| Duty gear | |
| Bianchi holsters..... | 58 |
| Equipment bag | 57 |
| With brass fittings | 53 |
| Edge dressing - leather..... | 7 |
| Embossed under-belt..... | 57 |
| Emergency equipment | |
| Barricade supplies..... | 118-119 |
| Safety cones | 117 |
| Epaulets - slip on..... | 6 |
| Flashlights | |
| 2 C-cell Mini-Maglites | 11 |
| 3 D-cell Maglites..... | 10 |
| Maglite LED upgrade kit | 12 |
| Rechargeable Maglites..... | 10 |
| Folding knives..... | 46 |
| Head wear | |
| Caps..... | 47 |
| Service caps..... | 48 |
| Insignias | |
| Name tags custom..... | 85, 86 |
| Key holders | 5 |
| Kiwi black polish | 7 |
| Leather care and cleaner..... | 7 |
| Polo shirt | |
| Police ID Polo | 20 |
| Polo shirts with ID | |
| Sheriff - EMS - FIRE | 5 |
| Winter cap | 7 |



RADIOS

| | |
|---------------------------|---------|
| Ear tip replacements..... | 6 |
| Headset adapters..... | 123 |
| Headsets | 124 |
| Microphones | 123 |
| Programmable radios..... | 122-123 |
| Radio holders | 122 |

REFLECTIVE PRODUCTS

| | |
|-------------------------------|-----|
| Add a reflective stripe | 25 |
| Duty vests..... | 120 |
| Emergency vests..... | 121 |
| Safety vests | 120 |
| Security vests | 120 |



SECURITY BOOTH

SHIRT

| | |
|---------------------------|----|
| 100% Cotton t-shirts..... | 20 |
| BDU sweaters | 17 |
| BDU uniform shirts..... | 17 |
| EMT white..... | 36 |

| | |
|---------------------------------|------------|
| EMT white dress shirts | 13 |
| Half-sleeve uniform shirts..... | 15-16 |
| LAPD certified shirts | 16-17 |
| Polo Shirt | |
| IDs on collar & cuffs | 19 |
| Large IDs front & back | 19 |
| Police IDs front & back..... | 20 |
| Poly cotton 3 color polo..... | 21 |
| Preshrunk cotton..... | 18 |
| Security IDs front & back | 18, 20, 21 |
| Polycotton uniform shirts..... | 13 |
| Polyester uniform shirts | 15 |
| Sheriff Class A shirt..... | 22 |
| Sheriff Class B shirt..... | 22 |
| T-Shirt plain..... | 7 |
| Turtleneck..... | 7 |
| Two tone uniform shirts..... | 14 |
| Uniform shirts | |
| Polycotton..... | 36 |
| Uniform wool shirts | 22 |
| White dress shirts | 13 |

SPECIAL SERVICES

| | |
|---------------------------|--------|
| Embroidery services | 128 |
| Engraving | |
| Name tags..... | 85, 86 |
| Silkscreen services..... | 128 |
| Tailoring services | 128 |

SPEED BUMP SYSTEMS

STUN GUNS.....



WARNING LIGHTS

| | |
|----------------------------------------------|----------|
| Beacon lights | |
| Double flashing strobe..... | 111 |
| Single flashing strobe..... | 111 |
| Twin beam rotating beacon | 111 |
| Combo Strobe-Halogen-LED..... | 98-99 |
| Compact LED lights | 112 |
| Compact strobe lights | 112 |
| Customizable arrowstick lights | 106 |
| Dash & deck lights..... | 107 |
| Flashing teardrop light | 111 |
| Halogen rotating & speaker..... | 109, 110 |
| Halogen rotating lights | 108 |
| Hideaway strobe light..... | 114 |
| Mini halogen rotating lights..... | 110 |
| Mini strobe lightbars | 104 |
| Opti-range halogen | 105 |
| Opti-range LED..... | 102-103 |
| Opti-range stealth | 96-97 |
| Opti-range stealth ultra..... | 100-101 |
| Opti-range strobe | 104 |
| Replacement parts | |
| Opti-range | 103 |
| Streamlined single LED light | 115 |
| Streamlined ultra | 94-95 |
| Tow truck lights. <i>See</i> 92,94,96,98,100 | |
| Ultra arrowstick series..... | 107 |
| Ultra slim arrowstick..... | 106 |
| Vanguard 3000 | 92-93 |
| Wide dispersion strobe..... | 112 |

WEB SITE INFORMATION.....

How-to-Measure for Men And Women

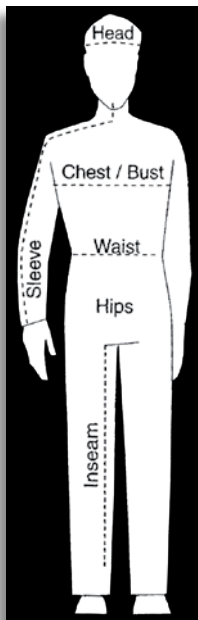

FOR HELMETS, CAPS OR HAT SIZE Use a cloth measuring tape to determine your correct cap or hat size. Measure completely around the head, starting 1" above the eyebrows in the front and going around the largest point at the back of the head. (See chart below)

FOR CHEST/BUST SIZE — Measure just below the arms, completely around the back and across the broadest part of the chest area. Hold tape firm and level.

NECK — Measure a shirt that fits you well. Lay the collar flat and measure from the center of the collar button to the far end of the button hole. The number of inches equals your size.

SLEEVE — Measure from the center of the collar (in the back), across the shoulder and down the sleeve. Number of inches equals sleeve length.

FOR WOMEN'S HIPS — Stand with heels together and measure around the fullest part of hips.

INSEAM — Take a pair of uniform pants (not jeans) that fits you well. Measure (to nearest inch) from the crotch seam to the bottom of pants.

BELTS — Order your belt 2" larger than your waist size. If between "even" sizes, order the next larger size.

GLOVES — Measure around your dominant hand at fullest part (exclude thumb). Number of inches equals glove size.

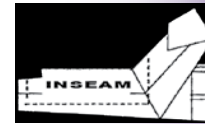

MAKE A COPY OF THIS RULER TO MEASURE AND CHECK YOUR SIZES

Shoe/boot Size Conversion Chart

| Men's Size | 6 | 7 | 7½ | 8 | 8½ | 9 | 9½ | 10 | 10½ | 11 | 11½ | 12 | 12½ | 13 | 14 |
|--------------|---|----|----|----|----|-----|----|-----|-----|-----|-----|-----|-----|-----|-----|
| Women's Size | | 8½ | 9 | 9½ | 10 | 10½ | 11 | 11½ | 12 | 12½ | 13 | 13½ | 14 | 14½ | 15½ |

SHIRT NECK SIZE CHART

| Small | Medium | Large | XL | 2XL | 3XL | 4XL | 5XL |
|--------|--------|--------|--------|--------|--------|--------|--------|
| 14-14½ | 15-15½ | 16-16½ | 17-17½ | 18-18½ | 19-19½ | 20-20½ | 21-21½ |

HAT CONVERSION CHART

| | S | | M | | L | | XL | XXL | | | | |
|--------|-------------------------------|-----|--------------------------------|----|-------------------------------|-----|-------------------------------|--------------------------------|-------------------------------|-----|-------------------------------|--------------------------------|
| US | 6 ⁵ / ₈ | 6¾ | 6 ⁷ / ₈ | 7 | 7 ¹ / ₈ | 7¼ | 7 ³ / ₈ | 7½ | 7 ⁵ / ₈ | 7¾ | 7 ⁷ / ₈ | 8 |
| CM | 53 | 54 | 55 | 56 | 57 | 58 | 59 | 60 | 61 | 62 | 63 | 64 |
| Inches | 20¾ | 21¼ | 21 ⁵ / ₈ | 22 | 22½ | 22¾ | 23¼ | 23 ⁵ / ₈ | 24 | 24½ | 24¾ | 25 ¹ / ₈ |

JACKET CHEST SIZE CHART

| Small | Medium | Large | XL | 2XL | 3XL | 4XL | 5XL |
|-------|--------|-------|-------|-------|-------|-------|-----|
| 32-34 | 36-38 | 40-42 | 44-46 | 48-50 | 52-54 | 56-58 | 60 |

GLOVE SIZE CHART

| Small | Medium | Large | XL | 2XL | 3XL |
|-------|--------|-------|----|-----|-----|
| 8 | 9 | 10 | 11 | 12 | 13 |

Tel: (877) 643-1100 ---- Toll Free
 Fax: (877) 700-4477 ---- Toll Free

(818) 341-1500 (US & NON US calls) PST
 (818) 341-0015 (US & NON US calls) PST

Phone Ordering
 M-F 7am - 5:30pm
 Sat 9am - 2pm



4 Easy Ways To Order

Call

Call our toll-free number:

877-643-1100 (US customers only)

818-341-1500 (US & Non US customers)

Monday - Friday: 7:00 am - 5:00 pm PST

Saturday 9:00 am - 2:00 pm PST

Drop In

Visit our retail store at:
18317 Napa St.
Northridge, CA 91325

Fax

Fax your order to:

877-700-4477 (US customers only)

818-341-0015 (US & Non US customers)

24 hours a day

Online

Browse & buy from our secure site:

uniforms4all.com

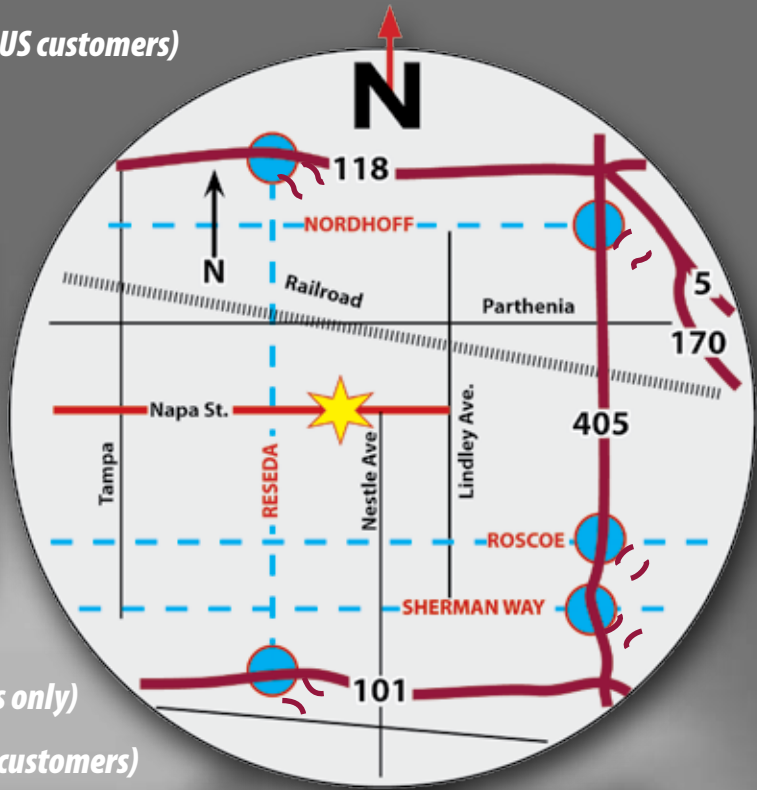

PRESORTED
STANDARD
U.S. POSTAGE

PAID

Canoga Park, CA
Permit No. 208

UNIFORMS & ACCESSORIES WAREHOUSE

18317 Napa St. Northridge, CA 91325

Tel: (877) 643-1100 Toll Free (US Only)

(818) 341-1500 (US & Non US)

Fax: (877) 700-4477 Toll Free (US Only)

(818) 341-0015 (US & Non US)

Store Hours: 9:00am - 5:00pm (M - F) PST

9:00am - 2:00pm (Sat) PST