

2011

Uniform & Accessories Warehouse

BADGES
FOOT WEAR
HEAD WEAR
UNIFORMS

JACKETS
FLASHLIGHTS
OUTERWEAR
SHIRTS

DUTY GEAR
BODY ARMOR
LIGHTBARS
EMBLEMS

AND MUCH MORE...



uniforms4all.com • 818-341-1500 • 877-643-1100

How Can We Help YOU?

**We want you to be completely satisfied with your purchases from us!
Please feel free to contact our friendly customer care representatives for assistance.**

WE OFFER

- **HIGH QUALITY PRODUCTS • FACTORY DIRECT LOW PRICES • FAST SHIPPING**
- **KNOWLEDGEABLE CUSTOMER CARE • HARD TO FIND ITEMS • 24 HOUR A DAY ONLINE ORDERING**

CLAIMS

We take great care to prepare all orders for shipment. Most orders that we ship arrive in excellent condition. Upon receipt of your purchase, please inspect the package(s) and check the invoice (located in the pouch on the 1st box) to ensure you received your entire order.

If you receive a damaged package, please refuse the package and immediately contact our customer service department. All claims must be reported within 24 hours of receipt.

CONVENIENT PAYMENT OPTIONS

We accept most credit cards! You may make purchases via money order, cashier's checks, money transfers and now even checks by phone. You can also email us your orders. We also accept purchase orders upon approval.

Past due accounts will be subjected to a finance charge and possibly a re-invoicing fee. All invoices over 60 days will be sent to collections and are subject to a collections fee. Returned items may include a restocking fee.



RETURNS

If within 30 days of receipt you are not satisfied with your purchase, you may exchange or return non-tailored & non-custom items in the original condition and packaging. Upon approval, custom items such as lightbars, special orders, custom badges or emblems, uniforms with tailoring may be returned for adjustment if we have not made them in accordance with your detailed instructions. All returned merchandise is subject to approval by the Returns Department. Every package subject to return or exchange must be followed by a RMA number, which can be obtained from our Returns Dept. The RMA number is active for 14 days following the date of issue. All packages received without a RMA or an expired RMA will be refused. You may make changes to an order before we ship it to you. However, after an order has been processed, a restocking fee may be billed to your account for any cancellations. **Shipping charges are non-refundable.**

SHIPPING METHOD

Shipping charges may vary according to size, weight and location of shipment. Expedited shipping fees may apply. Please contact a customer care representative for any shipping inquiries.

MISCELLANEOUS

U.A.W. strives to maintain accuracy for all our catalogs and mailers. We are not responsible for misprints due to human error or mistakes by the editor.

All prices are subject to change without notice.

LAW ENFORCEMENT SALES POLICY

It is the customer's responsibility to verify that the purchase and use of any product from U.A.W. is legal and free of restrictions in their home state. Customers shall warrant to U.A.W. that they are authorized to make purchases and that they are in full compliance with local, state and federal laws regarding restricted items. U.A.W. shall not be held liable for customer's use of such equipment. To verify legal restrictions on purchasing and using all such items, contact your local authorities. There are no other warranties, expressed or implied, including but not limited to, any implied warranties of merchantability or fitness for a particular purpose. In no event shall U.A.W. be liable for any loss of profits or any indirect or consequential damages arising out of any such defect in material or workmanship.

Verifiable proof of occupation must be submitted for all police, sheriff & law enforcement items and accessories.

LIGHTBAR WARRANTY

If you receive a damaged package, please refuse the package and immediately contact our customer care department. All damages must be reported within 24 hours of receipt.

- **Warranty begins from date of purchase • Warranty on lightbars is 12 months on hardware • Customer is responsible for all shipping on warranty repairs • After the warranty period ends the customer is responsible for all charges**

2 Tel: (877) 643-1100 ---- Toll Free
Fax: (877) 700-4477 ---- Toll Free

(818) 341-1500 (US & NON US calls)
(818) 341-0015 (US & NON US calls)

Phone ordering only
M-F 7:30am - 5:00pm PST
Sat 9am - 2pm PST

U.A.W PHONE NUMBERS

US Only Orders877-643-1100
 US & Non US Orders818-341-1500
 US Only Fax.....877-700-4477
 US & Non US Fax818-341-9900
818-341-0015
 US Only Customer Service818-341-1500
 US & Non US Customer Service ..818-341-1500
 Internet Orders uniforms4all.com

WE EMBROIDER!



We do custom embroidery on shirts, hats and jackets. Call for details, scheduling and pricing. *See page 111 for full details*

WE ENGRAVE!



Engraving services have expanded to specialty selections. We also offer specialty name tags in silver and gold. *See pages 109-110*
 Call for details or order on line.

CUSTOM ID LABELS



Call for
 details
 and
 pricing

YOUR TEXT
 HERE

WE DO TAILORING!

Our basic tailoring services include sewing emblems on shirts, jackets & hats. We hem pants and do color pant stripping pant on legs. No minimum order for tailored items.

See page 33 for full details

TABLE OF CONTENTS

BATONS	61 - 62
BADGES CUSTOM	86 - 90
BADGES STOCK.....	91 - 96
BATTERIES	78 & 117
BODY ARMOR	56
CUSTOMIZING SERVICES.....	111
DRESS UNIFORMS.....	33 - 42
DUTY GEAR.....	47 - 64
EMBLEMS CUSTOM.....	97 - 99
EMBLEMS STOCK	100 - 105
EMERGENCY EQUIPMENT	144 - 149
FLASHLIGHTS	70 - 77
FLYING CROSS UNIFORMS.....	30 - 32
FOOTWEAR	67 - 69
GUARDSCAN/METAL DETECTOR	81 - 85
HANDCUFFS.....	58 & 59
HEAD WEAR	43 - 44
INSIGNIAS	106 - 110
JACKETS.....	4 - 15
KNIVES	80
MISCELLANEOUS	33 & 79
MEASURING & SIZE CHARTS	155
NEW ITEMS.....	150 - 154
PEPPER SPRAY	65
RADIOS	112 - 116
REFLECTIVE VESTS	45 - 46
SHIRTS	15 - 28
WARNING LIGHTS	118 - 143
WATCHES	66

WE SILK-SCREEN!



MINIMUM ORDER

Minimum 12 items per order. Pricing varies for detailed designs and colors

Have us silk screen your company logo, employee names, or job titles on to shirts, polos, t-shirts, hats or jackets etc....

See page 111 for details

PROOF OF OCCUPATION

VERIFIABLE PROOF OF OCCUPATION MUST BE SUBMITTED FOR ANY PURCHASE OF POLICE, SHERIFF AND ANY LAW ENFORCEMENT ITEMS AND ACCESSORIES.

Tel: (877) 643-1100 ---- Toll Free
 Fax: (877) 700-4477 ---- Toll Free

(818) 341-1500 (US & NON US calls)
 (818) 341-0015 (US & NON US calls)

Phone ordering only
 M-F 7:30am - 5:00pm PST
 Sat 9am - 2pm PST

4 JACKETS

ALL SEASON DELUXE BOMBER JACKET

- Premium water-repellent 100% Nylon Oxford shell for superior protection
- Removable inner lining with 100% polyester fiberfill provides comfort and warmth
- 5 color matching button front snaps conceals original YKK zipper for a clean frontal appearance
- Dense removable high quality faux fur

- collar completely insulates throat when worn in the upright position
- Adjustable Velcro shell conceals knit wristlets
- Removable hood with insulated fiberfill cushioning
- Shoulder epaulets
- 9" Size zippers for easy access to gear
- Badge tab with metal eyelet

- 2 pleated front pockets
- Trimmed with gold buttons
- Back elastic waistband for size adjustment and flexibility
- 3 inside pockets (1 stiff pocket with snap and 2 secure inside pockets)



Removable hood



Removable inner lining with zipper



9" side zipper on each side



Metal eyelet badge tab



Color Matching Front Snaps

MSRP \$79⁹⁹

\$29⁹⁹

JSH-04: NAVY BLUE

GOLD & SILVER REPLACEMENT BUTTONS

BN-03 BN-05

Set of 6 **\$4⁹⁹**

Available in sizes: • Small • Medium • Large • 1XL • 2XL • 3XL • 4XL • 5XL
Add \$5.00 for XL - 2XL, Add \$9.00 3XL - 5XL



MSRP \$79⁹⁹

JSH-06: BROWN \$39⁹⁹



MSRP \$79⁹⁹

JSH-02: BLACK \$29⁹⁹



MSRP \$79⁹⁹

JSH-05: GREEN \$39⁹⁹

FLEECE ZIP UP HOODED JACKET

- 80% Cotton/20% Polyester • 2 side pockets
- Lined with 100% polyester fleece • Front zipper: black

\$14⁹⁹

JS-11B BLACK

Sizes: Small-5XL
Add \$3.00 for XL-2XL,
Add \$5.00 for 3XL-5XL

ALSO AVAILABLE IN RED, YELLOW, GREEN AND ORANGE. CALL FOR DETAILS!



SPRING-FALL BOMBER STYLE JACKET



Liner is removeable allowing this jacket to be used for all seasons

NEW

\$24⁹⁹

JS-102 BLACK JS-104 NAVY BLUE

Sizes: Small-5XL
Add \$3.00 for XL-2XL,
Add \$5.00 for 3XL-5XL

Tel: (877) 643-1100 ---- Toll Free
Fax: (877) 700-4477 ---- Toll Free

(818) 341-1500 (US & NON US calls)
(818) 341-0015 (US & NON US calls)

Phone Ordering Only
M-F 7:30am - 5:00pm PST
Sat 9am - 2pm PST

ALL SEASON DELUXE JACKET

- 100% Nylon waterproof, windproof and breathable outer shell for comfort and protection from the weather
- Removable micro fleece inner lining provides warmth and comfort
- 3 concealable pull down, high visibility identifier panels with zipper (IDs sold separately see below)
 - 2 small front identifiers & - 1 large back identifier
- 6 color matching snaps help conceal the front zipper
- Closes at top to completely insulates throat when collar is up
- Adjustable snaps at wrists
- Concealed hood in collar compartment
- Shoulder epaulets and 2 plated front pockets
- 9" side vent zippers for easy access to duty belt
- Back elastic waistband for size adjustment and flexibility
- 2 inside zippered pockets and 2 separate pockets in the lining
- 2 Concealed lined hand warmer pockets
- Machine washable

Removable insulated all weather lining

2 inside zippered pockets & 2 in lining

Concealed hood

2 areas for small reflective identifiers (1 left - 1 right) IDJS-13 Shown

1 large optional removable back reflective identifiers IDJS-10 Shown

Combination sweater and snap style cuffs.

MSRP \$169⁹⁹

PRICE REDUCTION NOW ONLY \$89⁹⁹

Add \$5.00 for XL - 2XL, Add \$7.00 3XL - 5XL

See page 6

JSID-10: BLACK

WATCH-GUARD BOMBER JACKET

Without hindering your mobility, this jacket features warm insulation & tough outer linings. This jacket retains its shape & resists the elements with a 100% Nylon Oxford covering.

- Nylon inner linings with 100% polyester fiberfill cushions
- Windproof and insulated
- Faux fur collar provides warmth
- A clean frontal appearance
- Scalloped pockets include concealed pockets
- Jacket retains shape with a sturdy elastic waistband

Shoulder epaulets

Metal eyelet badge tab

JS-04: NAVY BLUE

JS-05: GREEN

JS-06: BROWN

JS-01: BLACK

MSRP \$39⁹⁹

PRICE REDUCTION NOW ONLY \$19⁹⁹

BLACK ONLY
ADD \$4.00 FOR OTHER COLORS

Available in sizes:
• Small • Medium • Large
• 1XL • 2XL • 3XL • 4XL • 5XL
Add \$3.00 for XL - 2XL;
\$5.00 for 3XL - 5XL

All prices subject to change. Any pictorial or typographical errors subject to correction when an order is placed.
Proof of occupation is required for purchase of any law enforcement items.

UAW WILL MATCH COMPETITORS PUBLISHED PRICES

6 JACKETS

ALL SEASON DELUXE JACKET

- 100% Nylon Oxford water-repellent and windproof outer shell
- Removable inner lining with 100% polyester fiberfill provides warmth and comfort
- Option of 3 concealable pull down, high visibility identifier panels with zipper (sold separately see below)
 - 2 small front identifiers & - 1 large back identifier
- 5 color matching button snaps conceals original YKK zipper for a clean frontal appearance
- Dense removable high quality faux fur collar completely insulates throat when collar is up
- Adjustable Velcro sleeve conceals knit wristlets
- Removable hood with insulated fiberfill cushioning
- Shoulder epaulets and 2 pleated front pockets
- 9" side zippers for easy access to duty belt
- Trimmed with gold buttons
- Back elastic waistband for size adjustment and flexibility
- 3 inside pockets (1 stiff pocket with snap and 2 secure inside pockets)



Shown with optional 2 removable small front reflective identifiers (1 left - 1 right) JSID-01 See on page 8



MSRP \$99⁹⁵
PRICE REDUCTION NOW ONLY
\$49⁹⁹

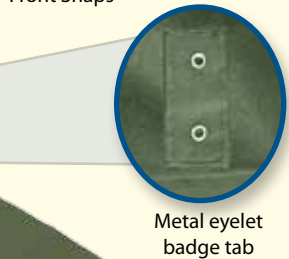

Metal eyelet badge tab



Shown with large, optional, removable, back reflective identifier IDJS-04 See on page 8

NAVY BLUE: JSID-04 GREEN : JSID-05 BROWN: JSID-06 BLACK: JSID-02

Add \$5.00 for XL - 2XL, Add \$7.00 for 3XL - 4XL
 Available in sizes: • Small • Medium • Large • 1XL • 2XL • 3XL • 4XL

REMOVABLE 3M REFLECTIVE OVERVEST AND UNDERJACKET



- Rugged Cordura/Taslan nylon water and stain repellent shell fabric with weather proof coating
- Overvest is reversible to high visibility fluorescent orange for safety
- Trimmed with Scotchlite® reflective trim and Thinsulate® insulation for sub-zero duty
- Set-in two-piece sleeve conforms to natural arm bend and provides superior comfort
- Hook-&-loop sleeve closures prevent updraft
- 10" zippered side vents (with snap/tab/ closures) for access to weapon or other equipment
- Two-piece collar for optimum fit. Detachable "seal" finish pile collar adds extra cold-weather protection
- Upper pocket with buttoned flap on vest
- Lower slash pocket and badge holders on both vest and underjacket
- Two-way Delrintm high-impact molded front zipper
- Dark facing prevents orange show-through

Blauer.
 Uncompromising Performance.
 MADE IN USA

JS-12

\$39⁹⁹

Available in sizes: Small - 4XL

ALL SIZES SAME PRICE

Tel: (877) 643-1100 ---- Toll Free
 Fax: (877) 700-4477 ---- Toll Free

(818) 341-1500 (US & NON US calls)
 (818) 341-0015 (US & NON US calls)

Phone Ordering Only
 M-F 7:30am - 5:00pm PST
 Sat 9am - 2pm PST

HIGH VISIBILITY FLUORESCENT REFLECTIVE JACKET & WATER RESISTANT PANTS

- Lightweight and durable • Water resistant 100% Nylon shell • Multiple reflective stripes • Hood easily stored in collar pouch
- Bright high visibility colors • Elastic cuffs and waistband to seal out the elements • Metal badge tab eyelets • 1 inner chest pocket • 2 deep hand pockets • Side zipper provides easy access to duty gear • 4" raisable collar



\$29⁹⁹

**JS-203
ORANGE**



\$19⁹⁹

**FP-01 PANTS LT GREEN
FP-02: PANTS ORANGE**

Available in sizes: Small - 4XL
Add \$5.00 for XL-2XL;
\$7.00 for 3XL-4XL

Available in sizes: **Small • Medium • Large • 1XL • 2XL • 3XL • 4XL • 5XL**
Elastic waistband and cuffs
Add \$5.00 for XL - 2XL,
Add \$7.00 3XL - 5XL

HIGH VISIBILITY REVERSIBLE JACKETS

- Light-weight and durable • Rain resistant • Deep lined pockets
- Meets ANSI/ISEA 107-1999 standards



\$39⁹⁹

**JS-202
FLUORESCENT
REVERSIBLE**

Add \$5.00 for XL - 2XL,
Add \$7.00 3XL - 5XL

HIGH VISIBILITY WINDBREAKER

- Bright high visibility yellow • Water resistant 100% Nylon shell • Reflective striping
- Optional 3 concealable identifiers (2 front & 1 rear) Sold separately • Elastic cuffs and draw string waistband



\$29⁹⁹

WBID-01

Add \$5.00 for XL-2XL,
Add \$7.00 for 3XL-4XL

Available in sizes: **Small • Medium • Large • 1XL • 2XL • 3XL • 4XL**



**ADD
REFLECTIVE
IDENTIFIERS**



See page 6

All prices subject to change. Any pictorial or typographical errors subject to correction when an order is placed.
Proof of occupation is required for purchase of any law enforcement items.

UAW WILL MATCH COMPETITORS PUBLISHED PRICES

8 JACKETS

ALL SEASON HIGH VISIBILITY DELUXE JACKET

- 100% Nylon Oxford water-repellent and windproof outer shell
- Removable inner lining with 100% polyester fiberfill provides warmth and comfort
- 3 concealable pull down, high visibility identifier panels with zipper (*sold separately see below*)
 - 2 small front identifiers & - 1 large back identifier
- 6 black button snaps conceal original zipper for a clean frontal appearance
- Dense collar completely insulates throat when worn in the upright position
- Adjustable Velcro shell tightens at the wrists
- Removable rain hood stores inside back of collar
- Side zippers open to armpit for easy access to duty gear
- 2 outer pockets with Velcro closure for easy access

ADD REFLECTIVE IDENTIFIERS

Bright yellow/green highly reflective material for safety



Removable hood with zippered storage

Reflective striping



2 optional removable small front identifiers (1 left - 1 right) IDJS-09 Shown

Side zippers open to armpit on each side

Removable lining

Available in sizes:

- Small • Medium • Large
- 1XL • 2XL • 3XL • 4XL • 5XL



1 large optional removable back identifiers IDJS-10 Shown

MSRP \$199⁹⁹



Add \$3.00 for XL - 2XL
Add \$5.00 for 3XL - 5XL

JS-07



\$2⁹⁹ Front: Each **Customize this jacket with the following reflective identifiers. \$7⁹⁹**

Dimensions: 7¼" x 3"

\$9⁹⁹ Combo: 2 fronts and 1 back ID

Back: Each

Dimensions: 15½" x 4½"

	EMS	EMT	SAFETY OFFICER	SECURITY	POLICE	YOUR OWN TITLE*
FRONT	IDJS-01	IDJS-03	IDJS-05	IDJS-07	IDJS-09	IDJS-30 \$14⁹⁹ Each
BACK	IDJS-02	IDJS-04	IDJS-06	IDJS-08	IDJS-10	IDJS-31 \$19⁹⁹ Each
	K-9 UNIT	SHERIFF	CROSSING GUARD	TRAFFIC CONTROL	TOW TRUCK OPERATOR	FIRE DEPT.
FRONT	IDJS-11	IDJS-13	IDJS-15	IDJS-17	IDJS-19	IDJS-21
BACK	IDJS-12	IDJS-14	IDJS-16	IDJS-18	IDJS-20	IDJS-22

For additional identifiers see our web site: www.uniforms4all.com *Additional charges may apply. Call for details.

Tel: (877) 643-1100 ---- Toll Free
Fax: (877) 700-4477 ---- Toll Free

(818) 341-1500 (US & NON US calls)
(818) 341-0015 (US & NON US calls)

Phone Ordering Only
M-F 7:30am - 5:00pm PST
Sat 9am - 2pm PST

TRICOLOR REFLECTIVE DELUXE JACKET AND VEST COMBO

Jacket includes: • Waterproof nylon outer shell • Inner lining with 100% polyester fiber fill provides comfort and warmth • Bright high visibility colors • 4 black button snaps conceal original zipper for a clean frontal appearance • Adjustable Velcro fasteners tightens at the wrists • Multiple reflective stripes • Insulated hand warmer pockets, outside left and right chest pockets for cell phone and 1 side zipper pocket for additional gear • Inside pockets for up to 3 pens, one zipper pocket and additional pocket with Velcro closure • Back elastic waistband for size adjustment and flexibility • Detachable hood with fiberfill inner lining

MSRP \$250⁹⁹
\$89⁹⁹
 JS-33 ▶

Complete set includes 1 jacket, 1 vest and the hood



Available in sizes: Small - 5XL
 Additional cost for all XL-5XL sizes

TRICOLOR REFLECTIVE DELUXE JACKET

Same jacket as above.



MSRP \$160⁹⁹
\$59⁹⁹
 JS-30 ▶

COMFORT LINED REFLECTIVE VEST

• Waterproof nylon outer shell and polyester fleece lining • High visibility yellow color with multiple reflective stripes • Insulated hand warmer pockets and double chest pocket



\$39⁹⁹
 JS-31 ▶

REFLECTIVE BALL CAP

HT-39 ▶
\$4⁹⁹



All prices subject to change. Any pictorial or typographical errors subject to correction when an order is placed.
 Proof of occupation is required for purchase of any law enforcement items.

UAW WILL MATCH COMPETITORS PUBLISHED PRICES

10 JACKETS

ULTRALIGHT BIKE PATROL JACKET



• Light weight bike jacket • Wind resistant • Water repellent • Very comfortable

•6.0 Oz. 100% Nylon plain weave •Sport collar with nylon interliner •Two 7 inch zippered welt pockets •Two way zippered front •Reflective piping on front and back •Two inch elasticized waistband •Two inch cuffs with hook and loop closure •Two nylon keepers inside of back waistband •Removable zip-out fleece liner •Solid or reflective printing available

LIMITED SUPPLY

- JS-51YB Yellow/Black**
- JS-51YN Yellow/Navy**
- JS-51RB Royal Blue/Black**
- JS-51RN Royal Blue/Navy**

\$29⁹⁹ Add \$10.00 for 2XL - 6XL

HIGH VISIBILITY RAINCOAT WITH REFLECTIVE STRIPES & IDS

Call about adding your own text!

Jacket ---->	Lime Green	Black
Plain No ID	JS-48	JS-47
SECURITY White ID	JS-48SW	JS-47SW
SECURITY Gold ID	-NA-	JS-47SG
SECURITY Black ID	JS-48SB	-NA-
POLICE White ID	JS-48PW	JS-47PW
POLICE Gold ID	-NA-	JS-47PG
POLICE Black ID	JS-48PB	-NA-
SHERIFF White ID	JS-48SHW	JS-47SHW
SHERIFF Gold ID	-NA-	JS-47SHG
SHERIFF Black ID	JS-48SHB	-NA-

COMING SOON



\$24⁹⁹

Sizes: Small - 3XL

BIKE PATROL TROUSERS



• 100% Nylon Taslan • Water Repellent - Moisture Wicking • Elastic Waistband • Zipper Fly • Tapered Leg design with zippered bottoms • Easy zip off legs

Available in sizes:
• Small • Medium • Large
• 1XL • 2XL • 3XL • 4XL

\$39⁹⁹

Add \$5.00 for 1XL - 4XL

◀ **BYP-04 BLACK**
BYP-06 DARK NAVY

NEW

BIKE PATROL SHORTS

• 100% Nylon Taslan • Water Repellent - Moisture Wicking • Multiple Pockets • Rear Zipper Pockets • Four Adjustable Belt Keepers • Elastic Waistband • Zipper Fly

Available in sizes:

• Small • Medium • Large
• 1XL • 2XL • 3XL • 4XL • 5XL



NEW

\$29⁹⁹

Add \$5.00 for 2XL - 5XL

▲ **BYS-04 BLACK**
BYS-06 DARK NAVY

Tel: (877) 643-1100 ---- Toll Free
Fax: (877) 700-4477 ---- Toll Free

(818) 341-1500 (US & NON US calls)
(818) 341-0015 (US & NON US calls)

Phone Ordering Only
M-F 7:30am - 5:00pm PST
Sat 9am - 2pm PST

THREE SEASON JACKET

This jacket will also keep you comfortable and warm in damp weather.



HAVE US ADD YOUR CHOICE OF EMBLEMS TO THESE JACKETS! (SOLD SEPARATELY)

- Great for company, department, group or team jacket
- Wind and moisture resistant nylon outer shell
- Fleece lined for comfort and warmth
- Knit waistband and cuff closure for warmth
- Zippered hand warmer pockets
- Inner chest pocket for small items
- Body and collar lined with fleece for comfort and warmth
- Sizes: Small - 5XL



\$29⁹⁹

Add \$5.00 for 1XL - 3XL,
Add \$9.00 4XL - 5XL

◀ **JS-45B BLACK W/ GREY**

JS-45NB NAVY W/ GREY ▶

ALSO AVAILABLE IN HUNTER GREEN/NAVY, KHAKI/BLACK, ROYAL BLUE/BLACK, RED/NAVY, NAVY/NAVY AND BLACK/BLACK FOR THESE COLORS ADD \$10⁰⁰ CALL FOR FULL INFORMATION.



FULL-LENGTH RAINCOATS 100% PVC

- Durable raincoat with removable snap-on drawstring hood
- Weather resistant back-flap
- Netted lining for warmth and durability
- Front storm flaps with 4 snap-on buttons
- Adjustable wristband snaps
- Wide side pockets
- Block lettering (3") back
- Block lettering (1½") front



\$9⁹⁹

Add \$_.00 for 1XL - 3XL, Add \$_.00 for 4XL - 5XL

All raincoats are available in sizes:

- Small • Medium • Large
- 1XL • 2XL • 3XL • 4XL • 5XL

PLAIN NO ID	SECURITY ID	POLICE ID	SHERIFF ID
JS-42	JS-40	JS-41	JS-44

100% PVC RAIN PONCHO



- Full length
- Attached Hood
- One size fits All
- Side Snaps

\$2⁹⁹

◀ **JS-43**

PLAIN RAIN PONCHO

All prices subject to change. Any pictorial or typographical errors subject to correction when an order is placed. Proof of occupation is required for purchase of any law enforcement items.

UAW WILL MATCH COMPETITORS PUBLISHED PRICES

ELITE WINDBREAKER JACKET WITH SECURITY ID & FLAG

100% NYLON SHELL WITH 5 CONVENIENT POCKETS

Our light-weight windbreaker offers equivalent features found in expensive brands.



All accessories sold separately

SILK-SCREENED SECURITY ID

Front: Silk-screened U.S. Flag on right & metal eyelet badge tab on left.

Back: White "SECURITY" identification (3½" H x 14" L)

Available in sizes:

- Small • Medium • Large
- 1XL • 2XL • 3XL • 4XL • 5XL



JS-16 BLACK W/ID

JS-18 NAVY BLUE W/ID

▲ **\$19⁹⁹**

Add \$5.00 for XL - 3XL, Add \$7.00 4XL - 5XL

JS-15 BLACK NO ID

JS-17 NAVY BLUE NO ID

◀ **\$18⁹⁹**

Add \$5.00 for XL - 3XL, Add \$7.00 4XL - 5XL

POLICE & SHERIFF ID WINDBREAKERS

- OPTIMIZED COMFORT
- 100% COTTON LINER
- 100% NYLON OUTER SHELL
- 100% WATER RESISTANT

- Extended length to guard hips
- Elastic cuffs
- Six color matching front snaps

Approximate ID size:
Front: 4 1/2"W X 1 1/4"H
Back: 14"W x 3"H

\$14⁹⁹ Add \$5.00 for XL - 2XL,
Add \$7.00 3XL - 5XL

WITH POLICE ID ▶

WB-08 BLACK WB-12 NAVY BLUE

WITH SHERIFF ID
WBSH-01 BLACK

Available in sizes:

- Small • Medium • Large
- 1XL • 2XL • 3XL • 4XL • 5XL



Tel: (877) 643-1100 ---- Toll Free
Fax: (877) 700-4477 ---- Toll Free

(818) 341-1500 (US & NON US calls)
(818) 341-0015 (US & NON US calls)

Phone Ordering Only
M-F 7:30am - 5:00pm PST
Sat 9am - 2pm PST

ELITE WINDBREAKER WITH POLICE ID

- 100% Nylon
- Left front pocket includes pen holder
- Additional utility side pockets
- 2 inner left chest pockets provide extra storage capacity
- 2 pleated breast pockets ensure a well-groomed look
- Elastic waistband creates a trim fit
- Adjustable button cuffs
- Gold buttons trim 2 front pockets and shoulder epaulets



\$19⁹⁹



JS-24: BLACK

JS-25: NAVY BLUE

Available in sizes: • Small • Medium • Large • 1XL • 2XL • 3XL • 4XL

Add \$3.00 for 2XL - 3XL, Add \$5.00 3XL - 4XL

EVENT STAFF WINDBREAKER

- 100% Nylon shell
- 3" EVENT STAFF silk screened on back
- 1½" EVENT STAFF lettering on left chest

Available sizes:
Small to 5XL

\$14⁹⁹

Add \$5.00 for XL-2XL
\$7.00 for 3XL-5XL



Elastic cuffs

Drawstring adjustable waist

WB-21: YELLOW WITH BLACK TEXT

PLAIN WINDBREAKERS

- Optimized comfort
- 100% Cotton Liner
- 100% Nylon Outer Shell
- 100% Water Resistant

- Extended length to guard hips
- Elastic cuffs
- Six color matching front snaps



WB-09 NAVY BLUE

\$9⁹⁹

Black and Navy Blue Only
Add \$5.00 for other colors



Elastic cuffs

Drawstring adjustable waist



**WB-16
RED**



**WB-17
YELLOW**



**WB-18
GREEN**



**WB-19
ORANGE**



**WB-03
BLACK**

Available in sizes:

• Small • Medium • Large • 1XL • 2XL • 3XL • 4XL • 5XL

Add \$3.00 for XL - 2XL, Add \$5.00 3XL - 5XL

All prices subject to change. Any pictorial or typographical errors subject to correction when an order is placed.

Proof of occupation is required for purchase of any law enforcement items.

UAW WILL MATCH COMPETITORS PUBLISHED PRICES

14 JACKETS

WINDBREAKERS WITH IDS

- OPTIMIZED FOR COMFORT • 100% COTTON LINER
- 100% NYLON OUTER SHELL • 100% WATER RESISTANT!
- Extended length to guard hips • Elastic cuffs
- Six color matching front snaps

With ID: Front IDs approximately Text is 4½" W x 1¼" H
 Back IDs approximately Text is 14" W x 3" H

\$9⁹⁹

Black & Navy with White ID only.
 Add \$8.00 for other color combinations



Available in sizes:

- Small • Medium • Large • 1XL • 2XL • 3XL • 4XL • 5XL
- Add \$3.00 for XL - 2XL, Add \$5.00 3XL - 5XL

Elastic cuffs

Drawstring adjustable waist

Jacket Color >>>	Black	Navy	Green	RED	YELLOW	FLOUR. ORANGE
Plain with no ID	WB-03	WB-09	WB-18	WB-16	WB-17	WB-19
SECURITY White ID	WB-03SW	WB-09SW	WB-18SW	WB-16SW	WB-17SW	WB-19SW
SECURITY Gold ID	WB-03SG	WB-09SG	WB-18SG	WB-16SG	WB-17SG	WB-19SG
SECURITY Black ID	-NA-	-NA-	-NA-	WB-16SB	WB-17SB	WB-19SB
POLICE White ID	WB-08	WB-12	WB-18PW	WB-16PW	WB-17PW	WB-19PW
POLICE Gold ID	WB-03PG	WB-09PG	WB-18PG	WB-16PG	WB-17PG	WB-19PG
POLICE Black ID	-NA-	-NA-	-NA-	WB-16PG	WB-17PB	WB-19PB
SHERIFF White ID	WBSH-01	WB-09SHW	WB-18SHW	WB-16SHW	WB-17SHW	WB-19SHW
SHERIFF Gold ID	WB-03SHG	WB-09SHG	WB-18SHG	WB-16SHG	WB-17SHG	WB-19SHG
SHERIFF Black ID	-NA-	-NA-	-NA-	WB-16SHB	WB-17SHB	WB-19SHB

Tel: (877) 643-1100 ---- Toll Free
 Fax: (877) 700-4477 ---- Toll Free

(818) 341-1500 (US & NON US calls)
 (818) 341-0015 (US & NON US calls)

Phone Ordering Only
 M-F 7:30am - 5:00pm PST
 Sat 9am - 2pm PST

ELITE WINDBREAKER JACKET WITH SILK SCREEN SECURITY ID

- 100% Nylon • 5 convenient pockets • Includes features found in expensive brands • Silk screened ID on front and back

\$19⁹⁹

Add \$5.00 for XL-5XL

Available in sizes:

- Small • Medium • Large
- 1XL • 2XL • 3XL • 4XL • 5XL



Call for availability

Jacket Color >>>	Black	Navy	Olive Green
Plain with No ID	JS-15	JS-17	JS-23
SECURITY White ID	JS-20SW	JS-22SW	JS-23SW
SECURITY Gold ID	JS-20SG	JS-22SG	JS-23SG
POLICE White ID	JS-24	JS-25	JS-23PW
POLICE Gold ID	JS-20PW	JS-22PG	JS-23PG
SHERIFF White ID	JS-20SHW	JS-22SHW	JS-23SHW
SHERIFF Gold ID	JS-20SHG	JS-22SHG	JS-23SHG

100% POLYESTER UNIFORM SHIRTS

- Pleated Velcro patch pockets with scalloped flaps • Pen compartment in the left front pocket • Pointed collar with supports to keep your collar in place. • 5-point military creases & button down "X" stitched epaulets for uniformity
- Sturdy sling badge tab keeps badge in place • Placket sleeves include adjustable cuffs for comfort • Machine washable fabric resists stains and wrinkles



Short Sleeve
MSRP
\$17⁹⁹

PRICE REDUCTION NOW ONLY
\$7⁹⁹

Badge tab keeps badge in place



Long Sleeve
MSRP
\$18⁹⁹

PRICE REDUCTION NOW ONLY
\$8⁹⁹

SS-02: WHITE SHORT-SLEEVE

Available in sizes: Small - 5XL

Add \$2.00 for XL-2XL; \$5.00 for 3XL-5XL

LS-03: BLACK LONG-SLEEVE

Available Colors	White	Black	Navy Blue	Lt. Blue	Tan	Lt. Grey	Drk. Grey
Short Sleeve	SS-02	SS-04	SS-06	SS-08	SS-12	SS-18	SS-10
Long Sleeve	LS-01	LS-03	LS-05	LS-07	LS-13	LS-11	LS-09

SHIRT NECK SIZE CHART

Small	Medium	Large	XL	2L	3XL	4XL	5XL
14-14½	15-15½	16-16½	17-17½	18-18½	19-19½	20-20½	21-21½

All prices subject to change. Any pictorial or typographical errors subject to correction when an order is placed.

Proof of occupation is required for purchase of any law enforcement items.

UAW WILL MATCH COMPETITORS PUBLISHED PRICES

100% POLYESTER TWO TONE UNIFORM SHIRTS

- Two pleated pockets with pen compartment in left pocket
- Two sewn-in creases front & three sewn-in creases back
- Hook & loop scalloped flaps with Velcro closure
- Two button adjustable cuffs (on long sleeves)
- Placket front
- Double slit badge tab on left side of chest
- X-stitched shoulder epaulets
- Banded collar

See our slacks starting at page 34.

Short-sleeve

Available in sizes:
Small - 5XL



MSRP
\$19⁹⁹
PRICE REDUCTION NOW ONLY
\$8⁹⁹

Long-sleeve

Available in sizes:
Small - 5XL



MSRP
\$21⁹⁹
PRICE REDUCTION NOW ONLY
\$10⁹⁹

ALL SIZES SAME PRICE

White & Midnight
Navy Blue 2-Tone

Both shirts shown with optional with black tie. See page 38
Add \$2.00 for XL-2XL, add \$5.00 for 3XL-5XL



Available colors	Tan/brown	Light blue/black	Light Grey/black	White/Midnight Navy blue**	Dark grey/black*
Short Sleeve	TS-03	TS-19	TS-01	TS-09	TS-13
Long Sleeve	TL-03	TL-20	TL-01	TT-09	TS-22

** White 2-tone shirt matches Navy Blue or Black slacks.

SHIRT NECK SIZE CHART

Small	Medium	Large	XL	2XL	3XL	4XL	5XL
14-14½	15-15½	16-16½	17-17½	18-18½	19-19½	20-20½	21-21½

Tel: (877) 643-1100 ---- Toll Free
Fax: (877) 700-4477 ---- Toll Free

(818) 341-1500 (US & NON US calls)
(818) 341-0015 (US & NON US calls)

Phone Ordering Only
M-F 7:30am - 5:00pm PST
Sat 9am - 2pm PST

LAPD CERTIFIED 100% WORSTED WOOL SHIRTS

SHORT SLEEVE

- Short sleeve shirts include a lined convertible collar with internal collar stays which ensures shirts to appear sharp buttoned or unbuttoned
- Scalloped flap pockets complete with pen opening in left pocket
- Pocket flaps & shoulder straps accommodate metal buttons
- Metal badge eyelets
- Satin inner yoke & collar band for comfort
- Extra long tails keep shirt neatly in place
- Dry-clean only



\$49⁹⁹

Available in neck sizes: 14½" - 22"
Add \$10.00 for 19-20"; \$15.00 for 22"

NBL-01 Men's Short Sleeve LAPD blue
NBL-51 Women's Short Sleeve LAPD blue



LONG SLEEVE

- Long-sleeve features a lined banded dress collar with internal collar stays and "banjo" patch elbows
- Lined convertible collar & internal collar stays.
- Scalloped flap pockets complete with pen opening in left pocket
- Pocket flaps & shoulder straps accommodate metal buttons
- Satin inner yoke & collar band for comfort
- Extra long tails keep shirt neatly in place
- Dry-clean only

\$59⁹⁹

Available in neck sizes: 14½" - 22"
Sleeve length: 32" - 37"
Add \$12.00 for 19-20"; \$15.00 for 22"

NBL-02 Men's Long Sleeve LAPD blue
NBL-52 Women's Long Sleeve LAPD blue



Additional Services Available: Shirts available with zippered front for an additional \$6.99.

SHORT-SLEEVE 65% POLYESTER & 35% RAYON UNIFORM SHIRTS

- Poly-rayon fabric delivers the best in comfort and durability
- Convenient Velcro® pleated patch pockets with scalloped flaps create a crisp image
- Pen compartment is provided in the left front pocket
- Pointed collar features stays supports keeping your collar in place
- 5-point military creases & button down "X" stitched epaulets
- 7-button placket front
- Sturdy sling badge tab keeps badge in place



\$14⁹⁹ SHORT SLEEVE

\$15⁹⁹ LONG SLEEVE

Small-5XL Add \$4.00 for 1XL-2XL; \$7.00 for 3XL-5XL

	BLACK	BORDER GREEN	TAN	WHITE	FRENCH BLUE	NAVY BLUE	BROWN
SHORT SLEEVE	PRS-04	PRS-03	PRS-05	PRS-02	PRS-01	PRS-06	PRS-07
LONG SLEEVE	PRL-04	PRL-03	PRL-05	PRL-02	PRL-01	PRL-06	PRL-07

UAW WILL MATCH COMPETITORS PUBLISHED PRICES

CHILDREN'S 100% PRESHRUNK COTTON POLOS



PS-52
Red

\$5⁹⁹

Short-sleeve

- 100% preshrunk cotton • Reinforced stitching along the seams • Vented hem for secure tucking • Cool and comfortable

	Size	Chest	Length
Small	4-6	16"	21"
Medium	7-10	16½"	22½"
Large	11-15	19"	25"
XL	16-18	20½"	27"

Many more colors available as a special order.



PS-51
White



PS-52
Red



PS-53
Black

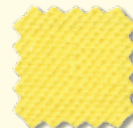

PS-54
Yellow



PS-55
Forest Green



PS-61
Navy Blue

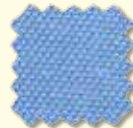

PS-56
Sky Blue



PS-57
Royal Blue

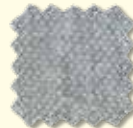

PS-58
Heather Grey



PS-59
Burgundy

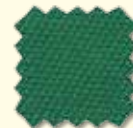

PS-60
Kelly Green

Available in child sizes:
Child Small to 1XL

100% POLYESTER ZIPPERED UNIFORM SHIRTS

- Pleated Velcro patch pockets with scalloped flaps • Pen compartment in the left front pocket • Pointed collar with stays to keep your collar in place. • 5-point military creases & button down "X" stitched epaulets for uniformity
- Sturdy sling badge tab keeps badge in place • Placket sleeves include adjustable cuffs for comfort • Machine washable fabric resists stains and wrinkles



Short Sleeve



Long Sleeve



Available in sizes: Small - 5XL

SS-20: White Short-sleeve shirt

Add \$5.00 for 2XL-5XL

Available in sizes: Small - 5XL

LS-22: Black Long-sleeve shirt

Available Colors	White	Black	Navy Blue	Lt. Blue	Tan	Lt. Grey	Drk. Grey
Short Sleeve with zipper	SS-20	SS-22	SS-24	SS-26	SS-34	SS-32	SS-28
Long Sleeve with zipper	LS-20	LS-22	LS-24	LS-26	LS-34	LS-32	LS-28

SHIRT NECK SIZE CHART

Small	Medium	Large	XL	2XL	3XL	4XL	5XL
14-14½	15-15½	16-16½	17-17½	18-18½	19-19½	20-20½	21-21½

Tel: (877) 643-1100 ---- Toll Free
Fax: (877) 700-4477 ---- Toll Free

(818) 341-1500 (US & NON US calls)
(818) 341-0015 (US & NON US calls)

Phone Ordering Only
M-F 7:30am - 5:00pm PST
Sat 9am - 2pm PST

POLY COTTON UNIFORM SHIRTS

RETAINS A CRISP IMAGE IN A COMFORTABLE ALTERNATIVE

- Placket sleeve with center button (on long sleeves)
- Two button adjustable cuffs (on long sleeves)
- Placket front pockets
- Double slit badge tab on left side of chest
- X-stitched shoulder epaulets
- Banded collar
- Two sewn-in creases in front & three sewn-in creases in back
- Two pleated pockets with pen compartment on left pocket
- Hook & loop scalloped flaps with Velcro closure
- Seven front buttons
- Sizes: Small - 5XL



\$10⁹⁹

\$11⁹⁹

\$12⁹⁹

\$12⁹⁹

**SC-30 SHORT-SLEEVE SHIRT
WHITE ONLY**

**SC-08 SHORT SLEEVE SHIRT
LT BLUE ONLY**

**LC-31 LONG-SLEEVE SHIRT
WHITE**

**LC-08 LONG-SLEEVE SHIRT
LT BLUE**

Add \$5.00 for 1XL-2XL; \$7.00 for 3XL-5XL

Add \$5.00 for 1XL-2XL; \$7.00 for 3XL-5XL

PROFESSIONAL WHITE DRESS SHIRT

- Poly Cotton blend for durability and comfort
- Open left chest pocket • Replacement button included • Machine washable

**SHORT SLEEVE
SS-30**

**LONG SLEEVE
LS-36**

\$9⁹⁹

\$10⁹⁹



Add \$3.00 for XL-3XL;
Add \$5.00 for 4XL-5XL

EMT WHITE UNIFORM SHIRT

- Ideal for emergency response, ambulance service, aviation & other attired personnel • Poly Cotton blend for durability and comfort • Features shoulder epaulets and button-through flapped pockets

\$11⁹⁹

**SHORT SLEEVE
EMT-01**



\$12⁹⁹

**LONG SLEEVE
EMT-02**

Pen slot in left flapped pocket

Add \$5.00 for XL-3XL;
Add \$7.00 for 4XL-5XL

SHIRT NECK SIZE CHART

Small	Medium	Large	XL	2L	3XL	4XL	5XL
14-14½	15-15½	16-16½	17-17½	18-18½	19-19½	20-20½	21-21½

All prices subject to change. Any pictorial or typographical errors subject to correction when an order is placed.

Proof of occupation is required for purchase of any law enforcement items.

UAW WILL MATCH COMPETITORS PUBLISHED PRICES

POLY COTTON DRESS SHIRTS

• 65% Polyester / 35% Cotton • 9.5-10 oz. Tropical Weave • Pleated pockets • Scalloped flaps • Hook & loop closures • Button front • Pen opening in left pocket • Badge eyelets with internal shoulder support strap • Stitched in military creases • Cross-stitched shoulder straps • Extra long tails • Machine washable • Sizes: S - 6XL



SHORT SLEEVE

\$13⁹⁹

Add \$5.00 for XL - 3XL,
Add \$9.00 for 4XL - 6XL

COLOR:

- ① SC-30 WHITE
- ② SC-08 LIGHT BLUE
- ③ SC-06 NAVY
- ④ SC-12 SILVER TAN
- ⑤ SC-18 GREY
- ⑥ SC-01 FRENCH BLUE
- ⑦ SC-03 BLACK



**EVERYDAY
LOW PRICES**



LONG SLEEVE

\$14⁹⁹

Add \$5.00 for XL - 3XL,
Add \$9.00 for 4XL - 6XL

COLOR:

- A LSC-31 WHITE
- B LSC-08 LIGHT BLUE
- C LSC-05 NAVY
- D LSC-13 SILVER TAN
- E LSC-11 GREY
- F LSC-03 BLACK
- G LSC-01 FRENCH BLUE



4 POCKET 65%/35% POLY COTTON TROUSERS



• 65% Polyester / 35% Cotton • 7.25-7.5 oz. twill with DuPont® Teflon® fabric protector • Repels water and oil based spills, breathable • Durable, safe and gentle • At-Ease™ slide adjustment waistband • Roomy thigh for freedom of movement under demanding use • Four pocket design provide room for critical equipment • Two front quarter pockets • Two back pockets • Double hook and eye closure • Bar tacks at stress points for durability • 7/8" inserted belt loops • French fly for additional support • Machine washable

P-34 BLACK
P-36 NAVY BLUE

\$19⁹⁹

Add \$5.00 for 42-50",
Add \$9.00 for 52-60"

Available sizes:
28"-60"

SHIRT NECK SIZE CHART

Small	Medium	Large	XL	2XL	3XL	4XL	5XL
14-14½	15-15½	16-16½	17-17½	18-18½	19-19½	20-20½	21-21½

Tel: (877) 643-1100 ---- Toll Free
Fax: (877) 700-4477 ---- Toll Free

(818) 341-1500 (US & NON US calls)
(818) 341-0015 (US & NON US calls)

Phone Ordering Only
M-F 7:30am - 5:00pm PST
Sat 9am - 2pm PST

100% WOOL ELBECO LAPD SHIRTS

- 100% Wool • Short sleeve • Button front • Heavy weight

\$69⁹⁹

Add \$7.00 for XL-4XL



NBHW-01 LAPD Blue only

Available in: Small - 4XL

BDU SHIRTS

- Polyester-cotton blend rip stop • Shoulder epaulets with buttons • Easy-access button closure • Adjustable 2 button sleeves • 2 front pockets with flap & button closure • Long sleeve • Left pocket pencil slot • Machine wash/dry

\$14⁹⁹

Black & Navy only Add \$4 for other colors

Add \$5.00 for XL - 5XL



BSH-01 BLACK
BSH-06 TAN

BSH-04 NAVY BLUE
BSH-05 LT. GREY

Available in: Small - 5XL

SWEATER VEST



\$19⁹⁹

BSV-03 BLACK
BSV-05 NAVY BLUE

- Add \$5.00 for XL-5XL
- Machine washable
- Sleeveless

COMMANDO SWEATER



\$24⁹⁹

BSW-01 BLACK
BSW-04 NAVY BLUE
BSW-06 GREEN

- Add \$5.00 for XL-5XL
- Fully reinforced with twill fabric patches on the sleeve and elbow
- Machine washable
- V-neck/badge tab

SHIRT NECK SIZE CHART

Small	Medium	Large	XL	2L	3XL	4XL	5XL
14-14½	15-15½	16-16½	17-17½	18-18½	19-19½	20-20½	21-21½

All prices subject to change. Any pictorial or typographical errors subject to correction when an order is placed.

Proof of occupation is required for purchase of any law enforcement items.

UAW WILL MATCH COMPETITORS PUBLISHED PRICES

ELBECO SHERIFF SHIRTS - CLASS A

ACADEMY CLASS (CLASS A)

- Tropical Weave
- 55% Polyester & 45% Worsted Wool
- Reinforced elbows & double-needle stitching throughout
- Metal badge eyelet

STS-03 SHORT SLEEVE CLASS A

\$34⁹⁹

Available in neck sizes: 14½" - 22"

Add \$7.00 for 19" - 20";
\$14.00 for 21"-22"



STS-02 LONG SLEEVE CLASS A

\$59⁹⁹

Available in neck sizes: 14½" - 22"

Add \$7.00 for 19"-20"; \$14.00 for 21"-22"

SHERIFF SHIRTS - CLASS B

SHERIFF DEPARTMENT (CLASS B)



- Poplin Weave
- 65% Polyester & 35% Cotton
- Top-fused convertible collar with internal stays
- Plain angled pockets, scalloped flaps, hook and loop closures



\$21⁹⁹

STS-01 SHORT SLEEVE CLASS B

Available in neck sizes: 14½" - 22"

Add \$4.00 for 19" - 20";
\$8.00 for 21"-22"

100% WORSTED WOOL UNIFORM SHIRTS

**SHORT SLEEVED SHIRT
MODELED AFTER
THE LAPD UNIFORM
SHIRT**

- X-stitched epaulets
- Lined collar
- Metal badge eyelet
- Scalloped pockets
- Zipper with faux button
- Double needle stitched seams
- Satin inner yoke & collar band for comfort

**MSRP
\$49⁹⁹**

\$29⁹⁹

**WS-01
NAVY BLUE SHORT-SLEEVE
WOOL SHIRT**

Available in sizes: Small - 4XL

Add \$5.00 for XL-2XL;
\$9.00 for 3XL-4XL



SHIRT NECK SIZE CHART

Small	Medium	Large	XL	2XL	3XL	4XL	5XL
14-14½	15-15½	16-16½	17-17½	18-18½	19-19½	20-20½	21-21½

Tel: (877) 643-1100 ---- Toll Free
Fax: (877) 700-4477 ---- Toll Free

(818) 341-1500 (US & NON US calls)
(818) 341-0015 (US & NON US calls)

Phone Ordering Only
M-F 7:30am - 5:00pm PST
Sat 9am - 2pm PST

100% PRESHRUNK COTTON SECURITY POLO SHIRTS WITH ID FRONT & BACK

• 3" SECURITY silk screened on back • 1½" SECURITY lettering on left chest • 3 button set-in placket front/vented sides

PS-11 ▲ **BLACK & WHITE TEXT**

PS-15 ▲ **NAVY BLUE & WHITE TEXT**

PS-12 ▲ **NAVY BLUE & GOLD TEXT**

PS-14 ▲ **HEATHER GREY & BLACK TEXT**

PS-13 ▲ **YELLOW & BLACK TEXT**

PS-38 ▲ **SKY BLUE & BLACK TEXT**

\$9⁹⁹

PS-10 **WHITE & BLACK TEXT**

Available sizes: Small to 5XL
Add \$3.00 for XL-3XL; \$5.00 for 4XL-5XL

WE OFFER MANY COMBINATIONS. PLEASE CALL FOR COMPLETE DETAILS.

3 COLOR POLY COTTON POLO SHIRTS

• 75% Cotton 25% Polyester • 100% Preshrunk Polo Shirts • Cool & Comfortable • 3 button set-in placket front • Available in White, Black, Navy Blue, Sand & Heather Grey Colors

PS-16 **BLACK & GREY COLLAR/CUFFS**

PS-18 **SAND & TAN COLLAR/CUFFS**

PS-19 **HEATHER GREY & GREY COLLAR/CUFFS**

PS-34 **WHITE & GREY COLLAR/CUFFS**

PS-17 **NAVY BLUE & GREY COLLAR/CUFFS**

\$9⁹⁹

Available sizes: Small to 3XL
Add \$4.00 for XL-3XL

EVENT STAFF T-SHIRTS

• Pre-shrunk 100% Cotton • Short sleeve

PS-43 **EVENT STAFF YELLOW/BLACK**

PS-44 **EVENT STAFF BLACK/WHITE**

\$7⁹⁹

Available sizes: Small to 5XL
Add \$3⁰⁰ for XL-2XL
Add \$5⁰⁰ for 3XL-5XL

SHIRT NECK SIZE CHART

Small	Medium	Large	XL	2L	3XL	4XL	5XL
14-14½	15-15½	16-16½	17-17½	18-18½	19-19½	20-20½	21-21½

All prices subject to change. Any pictorial or typographical errors subject to correction when an order is placed.

Proof of occupation is required for purchase of any law enforcement items.

UAW WILL MATCH COMPETITORS PUBLISHED PRICES

PLAIN SHORT SLEEVE T-SHIRTS

• 6 oz. 100% cotton • Double needled on bottom hem and sleeves • Shoulder-to-shoulder tape • Preshrunk to minimize shrinkage

\$4⁹⁹



PS-62
WHITE

PS-63
BLACK

Sizes:
Small-5XL
Add \$2.00 for
XL-2XL,
Add \$3.00 for
3XL-5XL

POLICE ID SHORT SLEEVE T-SHIRTS

• 6 oz. 100% cotton • ID on left chest and across back • Double needled on bottom hem and sleeves • Preshrunk to minimize shrinkage

\$6⁹⁹



Sizes:
Small-5XL
Add \$2.00 for
XL-2XL,
Add \$3.00 for
3XL-5XL

PS-40
BLACK

PS-41
WHITE

SHERIFF - EMS - FIRE DEPT POLY COTTON POLO ID SHIRTS

• Short sleeve • ID lettering on back of collar and both sleeves • 3 button set-in placket front



PS-35
GREY SHIRT/BLACK TEXT
SHERIFF

PS-36
NAVY BLUE SHIRT/WHITE TEXT
PS-87
NAVY BLUE SHIRT/GOLD TEXT

\$9⁹⁹

Available sizes: Small to 5XL
Add \$4.00 for XL-5XL

PS-37
NAVY BLUE SHIRT/
WHITE TEXT (FIRE DEPT)

POLYESTER/SPANDEX TURTLENECK

• 7 oz. 95% Polyester/5% Spandex • Stretches to fit • Reinforced collar, sleeves and shoulder seams

\$14⁹⁹

PS-50B: BLACK
PS-50W: WHITE

Sizes:
Small-5XL
Add \$2.00 for
XL-2XL,
Add \$3.00 for
3XL-5XL



POLO SHIRT WITH SECURITY ID

Heather Grey with Black ID



Sizes available:
Small-5XL

Add \$4.00 for XL-5XL

SP-72
\$9⁹⁹

SHIRT NECK SIZE CHART

Small	Medium	Large	XL	2XL	3XL	4XL	5XL
14-14½	15-15½	16-16½	17-17½	18-18½	19-19½	20-20½	21-21½

65/35 POLY COTTON UNIFORM SHIRT

- Ideal for EMT, EMS, transit drivers & other attired personnel
- 65/35 Poly Cotton blend for durability and comfort
- Features shoulder epaulets and button-through Oxford style open pockets

False flaps.
Pocket opens
only from top.



Light blue only

SHORT SLEEVE
SCB-01

\$12⁹⁹

Add \$4.00
for XL-3XL;
Add \$7.00
for 4XL-5XL

LONG SLEEVE
SCBL-02

\$14⁹⁹

Add \$4.00
for XL-3XL;
Add \$7.00
for 4XL-5XL

Available in sizes:
Small - 5XL

100% COTTON T-SHIRTS WITH ID

SHORT SLEEVED T-SHIRT
With Security ID in front and back



PS-08:
WHITE/BLACK

\$6⁹⁹

PS-09 BLACK/WHITE

PS-67 BLACK/GOLD

Available in sizes: Small - 5XL
Add \$3.00 for XL-3XL; \$5.00 for 4XL-5XL

100% COTTON POLICE POLO SHIRTS

**THESE POLO SHIRTS BRING A NEW LEVEL
OF COMFORT TO YOUR UNIFORMS**

- 100% preshrunk cotton
- Reinforced stitching along seams
- Vented sides for secure tucking
- Cool & comfortable



PP-42
NAVY BLUE & GOLD TEXT



PP-43 WHITE



PP-41
HEATHER GREY

\$9⁹⁹

Available sizes:
Small to 5XL

PP-44
BLACK & WHITE TEXT

Add \$4.00 for XL-5XL

SHIRT NECK SIZE CHART

Small	Medium	Large	XL	2L	3XL	4XL	5XL
14-14½	15-15½	16-16½	17-17½	18-18½	19-19½	20-20½	21-21½

All prices subject to change. Any pictorial or typographical errors subject to correction when an order is placed.
Proof of occupation is required for purchase of any law enforcement items.

UAW WILL MATCH COMPETITORS PUBLISHED PRICES

POLY COTTON LARGE ID POLICE, SECURITY & SHERIFF POLO SHIRTS

- 4" ID silk screened on back
- 2" ID lettering on left chest
- ID lettering on sleeves and back of collar
- 3 button set-in placket front
- Vented sides



\$9⁹⁹

Add \$5.00 for XL-5XL

\$9⁹⁹

Add \$5.00 for XL-5XL

- PP-35 WHITE/BLACK
- PP-36 BLACK/WHITE
- PP-37 NAVY BLUE/WHITE

- SP-30 WHITE/BLACK
- SP-34 NAVY BLUE/WHITE
- SP-32 BLACK/WHITE
- SP-70 NAVY BLUE/GOLD

- SHP-40 WHITE/BLACK
- SHP-41 BLACK/WHITE
- SHP-42 NAVY BLUE/WHITE

POLY COTTON POLICE ID POLO SHIRTS

- POLICE ID lettering on collar and sleeves
- 3 button set-in placket front
- Vented sides



POLICE
PP-38 WHITE

Available sizes: Small to 5XL

\$9⁹⁹

Add \$5.00 for XL-5X

Available colors:

- PP-38 WHITE
- PP-39 BLACK
- PP-40 NAVY BLUE

EVENT STAFF POLO SHIRT

- 3" EVENT STAFF silk screened on back
- 1½" EVENT STAFF lettering on left chest
- 3 button set-in placket front
- Vented sides



Available sizes: Small to 5XL

\$9⁹⁹

Add \$3.00 for XL-3XL
\$5.00 for 4XL-5XL

PS-42 YELLOW WITH BLACK TEXT

SHIRT NECK SIZE CHART

Small	Medium	Large	XL	2XL	3XL	4XL	5XL
14-14½	15-15½	16-16½	17-17½	18-18½	19-19½	20-20½	21-21½

Tel: (877) 643-1100 ---- Toll Free
Fax: (877) 700-4477 ---- Toll Free

(818) 341-1500 (US & NON US calls)
(818) 341-0015 (US & NON US calls)

Phone Ordering Only
M-F 7:30am - 5:00pm PST
Sat 9am - 2pm PST

POLY COTTON SECURITY ID POLO SHIRTS

SECURITY ID only on collar and sleeves

- 3 button set-in placket front
- Vented sides
- Embroider or silk screen your name and/or logo (See page 111)



Available sizes:
Small to 5XL

\$9⁹⁹

Add \$5.00 for XL-5XL

Available colors:

- SP-21 WHITE SP-23 BLACK SP-25 NAVY BLUE**
SP-73 HEATHER GREY

With SECURITY ID in front and back

- 3" SECURITY silk screened on back
- 1½" SECURITY lettering on left chest
- SECURITY lettering on collar and sleeves
- 3 button set-in placket front
- Vented sides

Pen pocket on left sleeve

Mic holder below front buttons and on both shoulders



\$10⁹⁹

Available sizes:
Small to 5XL

Add \$5.00 for XL-5XL

Available colors/text:

- SP-130 WHITE/DRK NAVY ID SP-134 NAVY BLUE/WHITE ID**
SP-170 NAVY BLUE/GOLD ID SP-132 BLACK/WHITE ID
SP-172 HEATHER GREY/BLACK ID

PRESHRUNK COTTON POLO SHIRTS

BRINGING A NEW LEVEL OF COMFORT TO YOUR UNIFORM

- 100% preshrunk cotton
- Reinforced stitching along seams
- Vented sides for secure tucking
- Cool & comfortable
- Embroider or silk screen your name and logo *See page 111 for full details*



PS-01 ▲
WHITE

PS-03 ▲
BLACK

PS-04 ▲
RED

PS-27 ▲
ROYAL BLUE

PS-06 ▲
HEATHER GREY

PS-22 ▲
YELLOW

PS-21 ▲
SKY BLUE

PS-05 ▲
NAVY BLUE

\$8⁹⁹

Available sizes: Small to 5XL

White, black, royal blue, heather grey, red and sand available up to 5XL.

All other colors available up to 2XL.

Add \$2.00 for XL-3XL; \$4.00 for 4XL-5XL

Other Available Colors:

PS-29 GOLD	PS-30 JADE	PS-20 TURQUOISE	PS-28 ORANGE
PS-26 PINK	PS-07 SAND	PS-23 BURGUNDY	PS-32 KELLY GREEN
		PS-24 FOREST GREEN	

Please indicate color when ordering these shirts

SHIRT NECK SIZE CHART

Small	Medium	Large	XL	2L	3XL	4XL	5XL
14-14½	15-15½	16-16½	17-17½	18-18½	19-19½	20-20½	21-21½

All prices subject to change. Any pictorial or typographical errors subject to correction when an order is placed.

Proof of occupation is required for purchase of any law enforcement items.

UAW WILL MATCH COMPETITORS PUBLISHED PRICES

SPECIAL ORDER POLY COTTON DRESS SHIRTS

These shirts are all custom orders.
Call for availability.

SHORT SLEEVE

WHITE : S, M, L, XL, 2XL, 3XL, 4XL, 5XL, 6XL
OTHERS : S, M, L, XL, 2XL

\$11⁹⁹ SHORT SLEEVE

LONG SLEEVE

WHITE : S, M, L, XL, 2XL, 3XL, 4XL, 5XL
BLACK : S-4XL
BURGANDY : S-4XL
OTHERS : S-2XL

\$10⁹⁹ LONG SLEEVE

Add \$3.00 for XL-6XL



Call for
ADDITIONAL
colors

Colors	Off White	Black	YELLOW	RED	Lilac	Burgandy	Hot Pink	Lt Blue	D Blue	Green	Purple
Short Sleeve	SS-40	SS-42	SS-43	SS-41	SS-48	SS-50	SS-52	SS-54	SS-56	SS-58	SS-60
Long Sleeve	LS-40	LS-42	LS-43	LS-41	LS-48	LS-50	LS-52	LS-54	LS-56	LS-58	LS-60

SECURITY POLY COTTON POLO ID SHIRTS

SECURITY ID

- 3" SECURITY silk screened on back
- 1 1/2" SECURITY lettering on left chest
- SECURITY lettering on collar and sleeves
- 3 button set-in placket front
- vented sides

- Short sleeve
- ID lettering on back of collar and both sleeves
- 3 button set-in placket front
- Sizes: Small - 5XL



\$9⁹⁹
SP-70
NAVY BLUE WITH GOLD ID

Add \$5.00 for
1XL-5XL



\$9⁹⁹
SP-71
NAVY BLUE WITH GOLD ID



HIGH VISIBILITY REFLECTIVE STRIPING

A reflective stripe can be a perfect safety addition for any nighttime or low-light activities. It is the same material used on highway cones. It is made using microscopic glass beads to allow it to reflect 1500 times more light than white fabric. We can add one to all your polo and other work shirts.



\$5⁹⁹
Each shirt
REF-01

SHIRT NECK SIZE CHART

Small	Medium	Large	XL	2XL	3XL	4XL	5XL
14-14 1/2	15-15 1/2	16-16 1/2	17-17 1/2	18-18 1/2	19-19 1/2	20-20 1/2	21-21 1/2

Tel: (877) 643-1100 ---- Toll Free
Fax: (877) 700-4477 ---- Toll Free

(818) 341-1500 (US & NON US calls)
(818) 341-0015 (US & NON US calls)

Phone Ordering Only
M-F 7:30am - 5:00pm PST
Sat 9am - 2pm PST

TACTICAL POLO SHIRTS

- 6 oz. Polyester/Cotton Outer shell • Blended cotton inside
- Moisture Management Fabric (keeps you dry) • Mic holder on both shoulders & below front buttons • Pen Pocket on left sleeve • Hemmed sleeves • Stain resistant - UV protected • Wrinkle Free - Odor control



Call about adding your own text!

- Available in sizes:
- Small • Medium • Large
 - 1XL • 2XL • 3XL • 4XL • 5XL

With IDs on front and back

\$19⁹⁹

ALL SIZES SAME PRICE



Shirt Color	White	Sky Blue	Yellow	Black	Navy	H Grey
PLAIN with No ID	PS-80	PS-81	PS-82	PS-84	PS-86	PS-83
SECURITY White ID	-NA-	PS-81SW	PS-82SW	PS-84SW	PS-86SW	-NA-
SECURITY Gold ID	-NA-	-NA-	-NA-	PS-84SG	PS-86SG	PS-83SG
SECURITY Black ID	PS-80SB	PS-81SB	PS-82SB	-NA-	-NA-	PS-83SB
POLICE White ID	-NA-	PS-81PW	PS-82PW	PS-84PW	PS-86PW	-NA-
POLICE Gold ID	-NA-	PS-81PG	PS-82PG	PS-84PG	PS-86PG	PS-83PG
POLICE Black ID	PS-80PB	PS-81PB	PS-82PB	-NA-	-NA-	PS-83PB
SHERIFF White ID	-NA-	PS-81SHW	PS-82SHW	PS-84SHW	PS-86SHW	-NA-
SHERIFF Gold ID	-NA-	-NA-	-NA-	PS-84SHG	PS-86SHG	PS-83SHG
SHERIFF Black ID	PS-80SHB	PS-81SHB	PS-82SHB	-NA-	-NA-	PS-83SHB

CASUAL DUTY TURTLENECK



- 92% Cotton • 8% Lycra® • Full turtleneck
- Long sleeves • Machine washable



\$14⁹⁹

- Available in sizes:
- Small • Medium • Large
 - 1XL • 2XL • 3XL • 4XL • 5XL

TN-04 BLACK
TN-06 DARK NAVY

SHIRT NECK SIZE CHART

Small	Medium	Large	XL	2L	3XL	4XL	5XL
14-14½	15-15½	16-16½	17-17½	18-18½	19-19½	20-20½	21-21½

All prices subject to change. Any pictorial or typographical errors subject to correction when an order is placed. Proof of occupation is required for purchase of any law enforcement items.

UAW WILL MATCH COMPETITORS PUBLISHED PRICES

ALL WEATHER DELUXE TROPICAL SHIRTS



The All Weather Deluxe Tropical weave shirts are comfortable and durable. They are made from 10-10½ ounce, 65/35 Poly/Rayon. These shirts are often imitated but never duplicated. The 6600 series is a sturdy yet breathable fabric that retains its body and drape. Wearers attest these Deluxe Tropicals become more comfortable after each machine washing! Available in many colors and styles, it's the choice of many agencies nationwide.

Deluxe Tropical shirt features include:

- Form-fitted tailored look designed to fit comfortably over body armor
- Pleated pockets with scalloped flaps and Velcro closures
- 5 permanent sewn in creases, two in the front continuing through pocket and flap and three in the back
- 7-button placket front
- Durable, double-stitched shoulder straps and pocket flaps
- Hidden pencil compartment
- Full badge sling
- Optional concealed zipper may be added

\$45⁹⁹

Short sleeve:

Available in sizes: Small - 5XL
Add \$9.00 for sizes 3XL - 5XL

\$49⁹⁹

Long sleeve:

Available in neck sizes: 14½" - 21½"
Add \$9.00 for neck sizes: 19½" - 21½"

Standard Shirt Colors

	Short sleeve	Long sleeve
LAPD BLUE	FCS-6686	FCL-6686
Medium Blue	FCS-6625	FCL-6625
White	FCS-6600	FCL-6600
Border Patrol Green	FCS-6687	NA
French Blue	FCS-6626	FCL-6626
Black	FCS-6610	FCL-6610
Nickel Grey	FCS-6651	FCL-6651
Silver Tan	FCS-6604	FCL-6604



65/35 POLYESTER/COTTON DURO POPLIN SHIRTS



The 5400 series of 65/35 Poly/Cotton, machine washable, Permanent Press material remains a popular choice for those who appreciate the benefits of Cotton and the durability of Polyester. It's available in a variety of styles and colors.

Standard Shirt Features Include:

- Form-fitted tailored look designed to fit comfortably over body armor
- Pleated pockets with scalloped flaps and Velcro closures
- 5 permanent sewn in creases, two in the front continuing through pocket and flap, and three in the back
- 7-button placket front
- Durable, double-stitched shoulder straps and pocket flaps
- Hidden pencil compartment
- Full badge sling
- Optional concealed zipper may be added

Long sleeve: **\$29⁹⁹**

Available in neck sizes: 14½" - 18½"
Add \$6.00 for 19½" - 21½"

Short sleeve: **\$27⁹⁹**

Available in neck sizes: 14½" - 21½"
Add \$6.00 for 19½" - 21½"

Available Colors	White	Navy Blue	M. Blue
Short Sleeve	FCS-5400	FCS-5456	FCS-5435
Long Sleeve	FCL-5400	NA	FCL-5435

Standard shirt colors



Tel: (877) 643-1100 ---- Toll Free
Fax: (877) 700-4477 ---- Toll Free

(818) 341-1500 (US & NON US calls)
(818) 341-0015 (US & NON US calls)

Phone Ordering Only
M-F 7:30am - 5:00pm PST
Sat 9am - 2pm PST

100% WOOL SHIRTS & TROUSERS



The 100% Wool LAPD Navy 9586 range shirts and matching trousers offer the utmost in styling, comfort, and durability. The wool fabric offers inherent natural breathability, and the incomparable California-styled favorite. Shirts are made in a 10-10½ ounce tropical weave, tailored with double needle stitching throughout, and include elbow reinforcement patches. Sewn buttons on shoulder straps and pockets are convertible to accommodate removable metal buttons.

Shirt also features:

- Form-fitted tailored look designed to fit comfortably over body armor
- High luster collar & yoke trim
- 7-button placket front
- Metal eyelet badge holder
- Plain pockets with scalloped flaps & Velcro® closure
- Cross-stitched shoulder straps
- Hidden pencil compartment
- An optional concealed zipper may be added

The trousers are made of durable, 2-ply, 17-17½, ounce, 100% Wool, feature hip and club pockets and a fully lined seat. Unhemmed.

SHIRTS: Men's

SHORT SLEEVE: FCS-9586

Available in neck sizes: 14½" - 21"
Add \$12.00 for 19" - 21"

\$49⁹⁹

LONG SLEEVE: FCL-9586

Available in neck sizes: 14½" - 21"
Add \$15.00 for 19" - 21"

\$59⁹⁹

SHIRTS: Women's



SHORT SLEEVE: FCS-9586W

Available in bust sizes: 32" - 44"

\$49⁹⁹

LONG SLEEVE: FCL-9586W

Available in neck sizes: 32" - 44"

\$59⁹⁹

TROUSERS

FCP-32289

Available in even sizes: 32" - 50"
Add \$10.00 for 44" - 50"

\$64⁹⁹



65/35 POLYESTER/COTTON RESPONSE WEAR

SHIRTS

- Available in Navy Blue
- Left breast pocket has imitation flap with convenient opening at top, and separate pencil compartment.
- Tailored generously for comfortable fit
- 5 permanent sewn in creases, two in the front continuing through pocket and flap, and three in the back
- 7-button placket front with concealed buttons
- Neck sizes: 14½" - 18½"

SHORT SLEEVE: FCS-5286

Add \$9.00 for 19", 20", 21"

\$27⁹⁹

LONG SLEEVE: FCL-5286

Add \$9.00 for 3XL - 5XL

\$39⁹⁹

TROUSERS

- Available in Navy Blue.
- Reinforced hook & eye closure with fully functional French-Fly tab
- Brass metal memory lock zipper for longer life
- Deep pockets preventing items from falling out
- Lined belt loops for improved appearance & added durability
- All pockets and stress points securely bar tacked for added strength
- Extra fabric at waist allows for let out
- Waist sizes: 32" - 50"
- Trousers unhemmed (36½")

\$29⁹⁹

FCP-4954

Add \$9.00 for 44" - 50"

All prices subject to change. Any pictorial or typographical errors subject to correction when an order is placed.

Proof of occupation is required for purchase of any law enforcement items.

UAW WILL MATCH COMPETITORS PUBLISHED PRICES

CHP MEN'S UNIFORMS

CHP certified uniforms for the California Highway Patrol. Premium uniform shirts and pants made with exact specifications. Available in wool blend and rayon tropical blend.



CHP MEN'S SHIRTS



- Plain pockets with scalloped flaps
- Cross-stitched shoulder straps and no military creases
- Elbow patch reinforcement on long sleeves
- 1/4" Double needle stitching throughout
- metal eyelet badge holder

◀ **FCL-6504**
\$49⁹⁹

CHP MEN'S LONG SLEEVE SHIRT SILVER TAN

9½ - 10 oz. 65/35 Polyester/Rayon, Tropical.
Available in neck sizes: 14½" - 20"; Add \$9.00 for 19" - 20"

UNITED UNIFORM
MANUFACTURERS, INC.
USL-6504
\$49⁹⁹



◀ **FCS-9404**
\$45⁹⁹

CHP MEN'S SHORT SLEEVE SHIRT SILVER TAN

9½ - 10 oz. 65/35 Polyester/Rayon, Tropical
Features a convertible sport collar with permanent collar stays. Available in sizes: Small - 5XL; Add \$9.00 for 3XL - 5XL

USS-9404
\$45⁹⁹

FCS-6504
\$69⁹⁹

CHP MEN'S SHORT SLEEVE SHIRT SILVER TAN

11½ - 12 oz. 2-ply 55% Polyester / 45% Wool
Features a convertible sport collar with permanent collar stays. Available in sizes: Small - 5XL; Add \$9.00 for 3XL - 5XL

USS-6504
\$69⁹⁹



◀ **FCP-CHP**
\$109⁹⁹

CHP MEN'S TROUSERS WITH BRAID

100% Wool, Elastique
Features half top pockets, 2" tunnel belt loops, club pockets, and watch pocket.
CHP braid sewn over side seam.
Unhemmed.
Available in odd and even sizes: 32" - 46"
Add \$10.00 for sizes 42" - 46" (even sizes only)

UCHP-CHP
\$109⁹⁹

FLYING CROSS/FECHEIMER SHERIFF SHIRTS



LA sheriff shirts certified for the Los Angeles County Sheriffs Department. Premium uniform shirt made with exact specifications.

SHERIFF'S CLASS B SHORT SLEEVE TAN SHIRT

65% Polyester / 35% Cotton Poplin

Features:

- Plain front pockets with pen compartment in left pocket
- Metal badge eyelet holder
- Fully lined placket fronts
- Convertible sports collar with permanent collar stays

Available in neck sizes: 14½" - 18½", 20" - 21"

FCS-5603 ▶
\$21⁹⁹

Add \$10.00 for neck sizes 20" - 21"



Tel: (877) 643-1100 ---- Toll Free
Fax: (877) 700-4477 ---- Toll Free

(818) 341-1500 (US & NON US calls)
(818) 341-0015 (US & NON US calls)

Phone Ordering Only
M-F 7:30am - 5:00pm PST
Sat 9am - 2pm PST

100% WOOL DRESS SUIT

For a professional appearance, 100% Wool Dress Suits provide both comfort and style. This suit coat is fully lined, includes an upper welt insulated pocket, 2 front flap pockets and 3 inside pockets (including pen compartment). The form fitting dress coat features side vents and 4 buttons on sleeve. Pants have a single pleat with a 1 1/2" waistband and 36" unhemmed length.



Available in chest and waist sizes with regular lengths:
 • 36" - 52" Chest
 • 30" - 46" Waist

Set comes with pant waist sizes that are 6" smaller than the chest size.



\$149⁹⁹

100% Wool Dress Suit

DSW-02
NAVY BLUE

DSW-01
BLACK

TAILORING SERVICES

Tailoring Fees:

- Hemming:** \$4.99 per pant
 - Collar tacking:** \$2.99 per shirt
 - Pant color striping:** \$6.99 per pant
- * No Minimum Order for tailored items

Call for details and scheduling.

Tailoring Per Emblem:

- Shirt:** \$0.99 per emblem, or \$1.49 per emblem with more than 4 angles (such as star patches)
- Jacket:** \$1.99 per emblem or \$2.49 per emblem with more than 4 angles
- Hat:** \$1.99 per emblem or \$2.49 per emblem with more than 4 angles



Any customized or tailored items are non returnable

Proof of occupation is required for purchase of any law enforcement items.

UAW WILL MATCH COMPETITORS PUBLISHED PRICES

SINGLE-BREADED PROFESSIONAL BLAZERS

- 100% Polyester
- Elegantly trimmed with gold buttons featured on front and sleeves
- Reinforced, comfortable lining and stitching throughout
- Form-fitting with 1/4" edge stitching
- Smooth back with center vent
- Two lower patch pockets with flaps
- Left breast welt pocket



\$29⁹⁹

BL-01: BURGUNDY



\$29⁹⁹

BL-07: BLACK



\$29⁹⁹

BL-03: NAVY BLUE

Available in chest sizes with regular lengths:

- Small (32-34)
- Medium (36 - 38)
- Large (40 - 42)
- 1XL (44 - 46)
- 2XL (48 - 50)
- 3XL (52 - 54)
- 4XL (56-58)

For all blazers add \$3.00 for XL-3XL and \$5.00 for 4XL

PROFESSIONAL UNIFORM SLACKS



- Twill weave with unique blended stitches for a seamless appearance
- 100% texturized Dacron polyester
- Grab & hold waistband liner designed to keep shirts snug
- Roomy side pockets: 9" pocket depth
- 6" pocket width darts for a better fit
- Smooth button closure
- Reinforced bar tacking on pockets, belt-loops, & zipper
- Fortified belt-loops
- Buttoned through back pockets
- Full interlining waistband
- Available in sizes: 28 - 60" waist

\$14⁹⁹

P-17: HEATHER GREY

Add \$5.00 for 42-50"; \$7.00 for 52-60"

Unhemmed. Tailoring available at \$3.99 per pair. See page 140

65/35 POLY-RAYON DRESS SUIT



Navy Blue

The 65/35 Poly-Rayon Dress Suit provides comfort and style with a professional appearance.

- Fully lined coat
- Upper weld insulated pocket
- 2 front flap pockets
- 3 inside pockets (including pen compartment)
- 4 buttons on each sleeve
- Pants:
 - Single pleat
 - 1 1/2" waistband
 - 36" unhemmed length

\$59⁹⁹

DS-01: BLACK
DS-02: NAVY BLUE

Available in chest sizes with regular lengths: Black: 36" - 52" waist
Navy Blue: 36" - 54" waist

The set comes with pant waist sizes that are 6" smaller than the chest size.

Add \$10.00 for waist sizes 44" - 54"

ELASTIQUE WEAVE UNIFORM SLACKS

7 POCKET UNIFORM TROUSERS 100% TEXTURIZED DACRON POLYESTER

- Flat front and back darts for form-fitting comfort
- Front closure features brass zipper, crush proof clasp, & curtain button
- Belt loops withstand heavy belts, will fit 2 1/4" belt
- Bartacking at stress points
- Deep front slash pockets

\$14⁹⁹

P-08 SPRUCE GREEN

Available in even waist sizes:
28 - 60" waist
Add \$5.00 for 42-50;
\$7.00 for 52-60



- Coin pocket near waistband
- 2 back pockets with left pocket button closure
- Additional SAP pockets for flashlights & other light-weight accessories
- Interlined waistband designed to keep shirts in place once tucked

Elastique weave fabric

Slacks with sap pockets available in these colors:



P-04 Black ▲

P-02 Dark Grey ▲

P-10 Brown ▲

P-06 Navy Blue ▲

P-08 Spruce Green ▲

Need a pant stripe to match your shirt? No problem!
Choose from our suggested colors for only \$6.99 per pair.

In-stock Stripe Colors: Available in 1" only

Stripe Color	Navy Blue	Black	White	Light Cyan	Gold	Tan	Red	Light Grey	Dark Grey	Silver
Item No.	ST-01	ST-03	ST-05	ST-07	ST-20	ST-09	ST-11	ST-15	ST-17	ST-21

READY TO SHIP PRE-STRIPED SLACKS

**SP-12
LIGHT BLUE
ON BLACK**



\$19⁹⁹

Available in sizes:
28 - 60" waist
comes with 1" striping
Add \$5.00 for 42-50;
\$9.00 for 52-60



Proof of occupation is required for purchase of any law enforcement items.

UAW WILL MATCH COMPETITORS PUBLISHED PRICES

100% POLYESTER TWILL WEAVE SLACKS



MSRP \$24⁹⁵
PRICE REDUCTION NOW ONLY
\$13⁹⁹

Add \$5.00 for 42-50;
 \$9.00 for 52-60

◀ **P-26 Navy Blue**
P-24 Black
 With Sap Pockets

100% POLYESTER EXCELLENT FOR SECURITY & POLICE OFFICERS

- Back darts for form-fitting comfort
- Front closure features brass zipper, crush proof clasp, & curtain button
- Belt loops withstand heavy belts, will fit 2 1/4" belt
- Bartacking at stress points
- Deep front slash pockets
- Coin or watch pocket near waistband
- 2 back pockets with left pocket button closure
- Interlined waistband designed to keep shirts in place

All sizes same price Available: 28" - 60"
 Available in even waist sizes
 Unhemmed. Tailoring available



MSRP \$19⁹⁵
PRICE REDUCTION NOW ONLY
\$11⁹⁹

Add \$5.00 for 42-50
 \$9.00 for 52-60

◀ **CHP-01 Navy Blue**
CHP-02 Black

Without Sap Pockets

BDU DUTY SHORTS



Tough construction for tactical maneuvers:

- Based on same design as our BDU pants
- 65% polyester & 35% cotton
- Quick drying fabric
- Reinforced seat
- Double-stitched seams
- Machine washable
- 6 Pockets: 2 front slash pockets, 2 rear pockets and 2 over sized cargo pockets
- Button closures on rear and cargo pockets
- Adjustable waist straps
- Button fly
- 21" in length

Available sizes:
Small (27-31)
Medium (32-35)
Large (35-39)
XL (39-42)
2XL (43-46)
3XL (48-50)
4XL (52-54)

Add \$5.00 for 2XL-3XL;
 \$7.00 for 4XL

\$19⁹⁹

◀ **BPS-10 Black** **BPS-12 Navy Blue**

Call for other available colors!
 Add \$5.00 for other colors

UNIFORM KHAKI SLACKS



- 63/35 Poly Cotton slacks hold a crisp uniform look
- 4 Heavy duty pockets: 2 slant pockets, 2 back hip pockets with left pocket button closure
- Fitted for comfort
- Brass zipper reinforced by snap button for a secure closure
- All stress points have bartack reinforcements

Available in even waist sizes:
 28-50" waist
 Add \$5.00 for 42-50

◀ **P-20 Khaki** **\$9⁹⁹**

Unhemmed. Tailoring available at \$4.99 per pair.

DUTY SHORTS



- 2 front and back button-down cargo pockets
- Deep 10" front slash pockets
- Reinforced stitching at stress points for added strength
- Vented hems on cuffs for a relaxed fit
- Additional cotton lining along waistband for comfort and strength
- 19" in length

Available sizes:
 Waist: 28 - 60"
 even sizes only

▲ **\$14⁹⁹**
PS-33 Black **PS-31 Navy blue**
 See duty gear section for belts.

Add \$5.00 for 42-50
 \$7.00 for 52-60



LAPD CERTIFIED UNIFORM TROUSERS BY ELBECO

100% Worsted Wool

- Straight front pockets • Watch pocket • 2 back hip pockets • 2 back billy pockets • Reinforced 3/4" inserted belt loops • Seat completely lined
- Sung-Tex waistband to keep shirts neatly tucked-in • Additional support provided by French fly • Bartacking at stress points • Dry clean only

\$69⁹⁹

NBL-03 Men's Navy Blue 100% wool ▶
NBL-04 Women's Navy Blue 100% wool

Available for both men & women:
 Men's even sizes 28"-58"
 Women's even sizes 8-24

FREE hemming.
 No exchanges or refunds on tailored items.

Add:
 \$6.00 for sizes 44-50
 \$10.00 for sizes 52-54
 \$15 for sizes 56, 58



CLASS A LA COUNTY CERTIFIED SHERIFF PANTS



- Polyester & Worsted wool • Straight front pockets
- Watch pocket • 2 back hip pockets
- 2 back billy pockets
- Reinforced 3/4" inserted belt loops
- Seat completely lined
- Sung-Tex waistband to keep shirts neatly tucked-in
- Additional support provided by French fly
- Bartacking at stress points
- Dry clean only



\$69⁹⁹

◀ **SGP-01 Sheriff's Green**

FREE hemming.
 No exchanges or refunds on tailored items.

Available in even sizes: 28"-58"
 Add:
 \$6.00 for sizes 44-50 \$10.00 for sizes 52-54
 \$15 for sizes 56, 58

CLASS A LA COUNTY CERTIFIED SHERIFF PANTS - LAPD APPROVED BRANDS

Polyester & Worsted Wool

- Seat completely lined • Straight front pockets • Sung-tex waistband to keep shirts neatly tucked-in • Watch pocket • 2 back hip pockets • 2 back billy pockets • Reinforced 3/4" inserted belt loops • Additional support provided by French fly
- Bartacking at stress points
- Dry clean only

Perfection Uniform Brand

\$59⁹⁹

4840FG Sheriff's Green ▶

Add: \$6.00 for sizes 44-50;
 \$10.00 for sizes 52-54; \$15 for sizes 56, 58



CLOSEOUT SALE

Available in sizes:
 30"- 44"

Other Brand Name

\$59⁹⁹

◀ **LAPD-01: LAPD Blue 100% wool**

Add: \$6.00 for sizes 44-50;
 \$10.00 for sizes 52-54; \$15 for sizes 56, 58

Proof of occupation is required for purchase of any law enforcement items.

UAW WILL MATCH COMPETITORS PUBLISHED PRICES

FIRST CLASS MOTOR BREECHES



FEATURES

- 2 inch waistband
- Sung-Tex with ban roll waistband & tunnel belt loops
- Deep front top pockets
- Rear back welt pockets and Billy pockets
- Heavy weight pocket fabric
- Triangle bar tacks
- Reinforced rounded seat
- Zippered leg
- Double knee
- Inside knee dart
- Pressed open leg seams
- Dry Clean Only

We accept purchase orders from government institutions, large corporations, and universities upon credit approval.

FABRIC: DAC/WOOL

- 16.5 oz. Elastic Weave
- 55% Polyester 45% Worsted Wool

- MB-20** Silver-Tan
- MB-06** Dark Navy
- MB-08** Heather Green
- MB-04** Black

\$59⁹⁹ Add \$9.00 for sizes 42-44

FABRIC: POLYESTER

- 16.5 oz. Elastic Weave
- 55% Polyester 45% Worsted Wool

- MBP-04** Black
- MBP-06** Navy Blue
- MBP-08** Heather Green
- MBP-10** Brown
- MBP-02** Dark Grey

\$39⁹⁹ Add \$9.00 for sizes 42-44

SIZE CHART

Inseam	Waist	30	32	34	36	38	40	42	44
	Reg (27")		✓	✓	✓	✓	✓	✓	✓

CLIP-ON & BREAK AWAY TIES

ADJUSTABLE CROSS TIES

Distinctive stripes allow personnel to wear with various colored shirts. Navy blue striped ties feature thin red, burgundy, & white stripes. Burgundy striped ties feature thin navy blue, gray-blue, & white stripes.

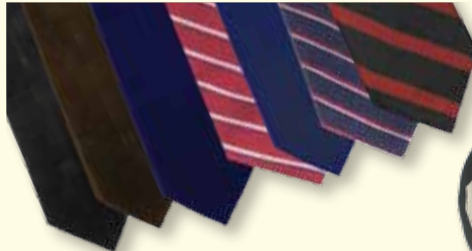

Clip-On

20" length

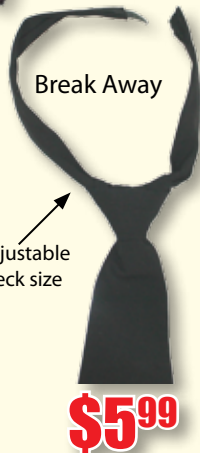

Break Away

Adjustable neck size



\$3⁹⁹

Features pearlesque snap



Color	Black	Navy Blue	Brown	Burgundy with stripes	Navy Blue with stripes	Royal Blue	Black with stripes
Clip-on Ties	CT-01	CT-03	CT-05	CT-07	CT-09	CT-14	CT-15
Break Away	CT-11	CT-12	CT-13	NA	NA	NA	NA
Cross Ties	CT-02	CT-04	CT-06	CT-08	CT-10	NA	CT-16

Check out our web site for many more of the latest law enforcement products at unbeatable prices

Tel: (877) 643-1100 ---- Toll Free
 Fax: (877) 700-4477 ---- Toll Free

(818) 341-1500 (US & NON US calls)
 (818) 341-0015 (US & NON US calls)

Phone Ordering Only
 M-F 7:30am - 5:00pm PST
 Sat 9am - 2pm PST

DURABLE EMS PANTS

- Poly Cotton
- Reinforced bar tacks at all stress points
- Front zip and hook closure
- 2 front pockets with flaps
- 2 back pockets with flaps and Velcro
- 2 cargo pockets with flaps
- Right cargo pocket has 3 slotted patches and 2 straps with snaps
- Unhemmed



**SAME DURABILITY
FOUND IN HIGHER
PRICED NAME
BRAND APPAREL**

\$24⁹⁹

Available sizes:
Waist: 28 - 60"
even sizes only

Add
\$5.00 for 42-50
\$7.00 for 52-60

▲ EMS-01 Navy blue

EMS-04 Black

RIP-STOP TACTICAL BDU PANTS

Tough construction:

- 65% polyester & 35% cotton 7.25-7.5oz Rip-Stop
- Quick drying fabric
- Reinforced seat and knee areas
- Double-stitched seams
- 6 Pockets: 2 front slash pockets,

2 rear pockets & 2 over-sized cargo pockets

- Button closures on rear and cargo pockets
- Adjustable waist straps
- Adjustable draw string bottoms
- Button fly



\$14⁹⁹

Black and Navy Blue only. Add \$4.00 for other colors

Available sizes:
Small (27-31)
Medium (32-35)
Large (35-39)
XL (39-42)
2XL (43-46)
3XL (48-50)
4XL (52-54)
5XL (56-60)

Add
\$5.00 for 2XL-3XL;
\$7.00 for 4XL-5XL



BP-02 Dark Grey BP-03 Brown BP-10 Black BP-12 Navy Blue
BP-14 Green BP-15 Lt. Grey BP-16 Khaki

COMING SOON

RIP-STOP EMS PANTS

EMS-106 Navy blue

EMS-104 Black

POLICE STYLE CARGO SHORTS



- 100% Cotton
- Extra Oversized Velcro pockets

\$14⁹⁹

Add \$5.00 for 42-50"

◀ **BLACK
BPS-104**

◀ **NAVY BLUE
BPS-106**

◀ **KHAKI
BPS-108**

◀ **OLIVE GREEN
BPS-109**

Sizes available: 30-50"

Proof of occupation is required for purchase of any law enforcement items.

UAW WILL MATCH COMPETITORS PUBLISHED PRICES

TROUSERS WITH CARGO POCKETS

- 100% Polyester • 11.5-12 oz. Tropical Weave • At-Ease™ slide adjustment waistband • Left & right Velcro closure cargo pockets • Cargo pockets have hi-viz strip when pocket flap is tucked in • Lined 7/8" inserted belt loops • Quarter top front pocket • Two back pockets with button tab on left pocket • Bar tacks at stress points for durability • Machine washable



TACTICAL SHIRT

- 100% Cotton • 5.4 oz. Canvas with DuPont® Teflon® fabric protector • Durable & Comfortable • Triple stitching • Cape back with moisture management mesh • Long sleeves with roll-up straps • Hidden button down collar



TACTICAL TRAINING TROUSERS

- 65% polyester & 35% Rip-Stop cotton 7¼-7½oz Rip-Stop Canvas • At-Ease™ Slide Adjustment waistband for added comfort • Unique 9 pocket design • 2 extra deep front slash pockets • 2 back pockets with rectangular flaps and Velcro® closures • 2 inverted pleat cargo pockets with Velcro® closure • 2 rear flashlight/sap pockets • Flashlight/Mag/Cell phone pocket with Velcro® closure • Interior knee-pad pockets (knee-pads not included) • Machine washable



TACTICAL VEST

- 65% Polyester / 35% Cotton Twill DuPont® Teflon® fabric protector • 8.5oz Cotton Canvas • Concealed crossover backup weapon pocket with Velcro closure • Unique 16 pocket design sized for mags, radios, flashlights, and pepper spray • Brass D-ring • Velcro badge tab



5.11 TACTICAL 100% COTTON PANTS

- Durable, comfortable and functional
- Superior fit
- Signature rear strap and slash pocket design
- Double and triple-stitch construction
- 48 bartacks in high stress areas
- Self-adjusting comfort waistband
- Double thick seat and knees (kneepad ready)
- Genuine YKK® zippers and PRYM® snaps
- Convenient D-ring
- Tough 8.5-oz. 100% cotton canvas
- 7 pockets, 4 colors
- Rear slash pockets
- Front D-ring holds keys, or ID



TCP-019 Black ▲



TCP-055 Khaki ▲



TCP-182 OD Green ▲



TCP-720 Fire Navy ▲



\$49⁹⁹

Available in even waist sizes:
28-54" waist
Add \$10.00 for 46-54"

All come unhemmed and tailored free of charge

5.11 TACTLITE® PRO PANTS 65/35 POLY COTTON

- Lightweight 65% polyester and 35% poly cotton ripstop
- Magazine/cell phone pocket
- Two cargo pockets
- Signature rear strap and slash pocket design
- Treated with HT Teflon® wear-resistant finish
- External knife pocket
- Rear web strap
- YKK® zippers
- Prym® snaps
- Clip loop
- Front D-ring holds keys, or ID
- Perfect for the outdoors, including hunting and hiking



▲ TPP-190 TDU Green



▲ TPP-724 Dark Navy



▲ TPP-019 Black



▲ TPP-162 TDU Khaki



\$49⁹⁹

Available in even waist sizes:
28-54" waist
Add \$10.00 for 46-54"

All come unhemmed and tailored free of charge



All prices subject to change. Any pictorial or typographical errors subject to correction when an order is placed.

Proof of occupation is required for purchase of any law enforcement items.

UAW WILL MATCH COMPETITORS PUBLISHED PRICES

TACTICAL POLO JERSEY

Made of 100% specially treated cotton, the 5.11 Tactical Polo is fade, shrink and wrinkle resistant. It can be worn in all types of conditions both on and off duty. These polo shirts are perfect for special programs such as bicycle patrol, casual on duty work, training facility wear, office wear and any other duty which does not demand a formal uniform.

- 6 oz. 100% specially treated cotton jersey
- Shrink and wrinkle resistant
- Tough melamine buttons
- No Roll Collar with flexible collar stays
- Mic-loop pockets located at each shoulder and placed at the bottom of the placket at the sternum level
- Reinforced dual pen pockets
- Accepts embroidery and silk screening
- Assorted colors

\$39⁹⁹ Add \$2.00 for XL-2XL;
\$5.00 for 3XL

Available in sizes: small - 3XL



TPJ-010
White

TPJ-019
Black

TPJ-160
Silver Tan

TPJ-724
Heather Grey

TPJ-016
Navy Blue

TACTICAL POLO JERSEY

Call for complete information and pricing on adding your own IDs!

Includes Police, Sheriff or Security IDs on the front pocket and the rear. You can even add the ID of your choice.



\$44⁹⁹

TPJ-010PB
White w/ Black ID

TPJ-019PW
Black w/ White ID

TPJ-019PG
Black w/ Gold ID

TPJ-160PB
Silver Tan w/ Black ID

TPJ-724PB
Heather w/ Black ID

TPJ-016PW
Navy w/ White ID

TPJ-016PG
Navy w/ Gold ID



\$44⁹⁹

TPJ-010SHB
White w/ Black ID

TPJ-019SHW
Black w/ White ID

TPJ-019SHG
Black w/ Gold ID

TPJ-160SHB
Silver Tan w/ Black ID

TPJ-724SHB
Heather Grey w/ Black ID

TPJ-016SHW
Navy w/ White ID

TPJ-016SHG
Navy w/ Gold ID



\$44⁹⁹

TPJ-01WBSE
White w/ Black ID

TPJ-019SW
Black w/ White ID

TPJ-019SG
Black w/ Gold ID

TPJ-160SB
Silver Tan w/ Black ID

TPJ-724SB
Heather Grey w/ Black ID

TPJ-016SW
Navy w/ White ID

TPJ-016SG
Navy w/ Gold ID

Tel: (877) 643-1100 ---- Toll Free
Fax: (877) 700-4477 ---- Toll Free

(818) 341-1500 (US & NON US calls)
(818) 341-0015 (US & NON US calls)

Phone Ordering Only
M-F 7:30am - 5:00pm PST
Sat 9am - 2pm PST

MASKS AND BEANIES

• One-size fits all • Shape retention • Raised 3D style embroidery



- | | | |
|---|---|---|
| A- HT-07: Plain Black Ski Mask \$3.99 | E- HT-21: Black Beanie with White Sheriff* \$4.99 | I- HT-18: Navy Blue Beanie with Gold Security \$4.99 |
| B- HT-09: Black Ski Mask with White Security \$4.99 | F- HT-24: Black Beanie with Gold Sheriff* \$4.99 | J- HT-25: Navy Blue Beanie with White Security \$4.99 |
| C- HT-10: Plain Black Beanie \$3.99 | G- HT-17: Black Beanie with Gold Security \$4.99 | K- HT-45: Navy Blue Beanie with Gold Police* \$4.99 |
| D- HT-20: Black Beanie with White Police* \$4.99 | H- HT-11: Black Beanie with White Security \$4.99 | L- HT-46: Black Beanie with Gold Police* \$4.99 |

(*All Police & sheriff Beanies require proof of occupation at time of order)

BALL CAPS

- Raised 3D style embroidery
- Back Velcro adjustment
- 6 paneled structure cap
- Reinforced stitching includes 6 sewn eyelets



\$3.99

HT-13: Plain Black Cap
HT-03: Plain Navy Blue Cap



- | | |
|--|---|
| HT-19: Black with White Police* \$4.99 | HT-29: Black with White Sheriff* |
| HT-38: Navy Blue with Gold Police* | HT-36: Black with Gold Sheriff* |
| HT-37: Navy Blue with White Police* | |
| HT-47: Black with Gold Police* | |

*All Police and Sheriff caps require proof of occupation at time of order



- | | | | | |
|---|---|---|--|--|
| A- HT-34: Navy Blue with White Fire Dept \$5.99 | C- HT-30: Navy Blue with White EMT \$5.99 | E- HT-06: Navy Blue with Gold Security \$4.99 | G- HT-05: Navy Blue with White Security \$4.99 | I- HT-15: Black with White Security \$7.99 |
| B- HT-33: Black with White Fire Dept | D- HT-32: Black with White EMT | F- HT-16: Black with Gold Security | H- HT-15: Black with White Security | J- HT-31: Black with EMT Patch |
| | | | K- HT-39: Bright/Reflective | |

All prices subject to change. Any pictorial or typographical errors subject to correction when an order is placed. Proof of occupation is required for purchase of any law enforcement items.

UAW WILL MATCH COMPETITORS PUBLISHED PRICES

44 HEAD WEAR

CAMPAIGN HAT*

• Summer hats made from genuine straw • Cool Comfortable • Lightweight
 SIZES: SML 6⁵/₈-6³/₄ M 7¹/₈-7¹/₄ XLRG 7¹/₂-7⁵/₈



\$19⁹⁹ HT-100 BLACK ▲



\$19⁹⁹ HT-106 NAVY BLUE ▲

*These hat brims may be straightened. Use a standard steam iron on medium heat over a towel or cloth.

HT-105: CHIN STRAP

Adjustable Leather Chin Strap
 (sold separately. Hat rope required)

\$5⁹⁹

HAT ROPES (SOLD SEPARATELY)

HR-00 BLACK & GOLD

HR-01 SILVER

HR-02 ALL GOLD

HR-03 ALL SILVER

\$6⁹⁹

FAUX FUR WINTER UNIFORM CAP

• Vinyl with faux fur lining • Flaps fold down to protect your ears from the cold • Insulated inner lining



Sizes: S, M, L, XL, 2XL

\$14⁹⁹ HT-22 ▲
 Color: Black

CUSHION AIR SERVICE CAPS



8 Point Service Hat with Combo Band

• Polyester construction • Navy material
 • Eyelet vent holes keeps you cool

SIZES: SML 6⁵/₈-6³/₄ M 7¹/₈-7¹/₄
 LRG 7¹/₄-7³/₈ XLRG 7¹/₂-7⁵/₈

\$24⁹⁹ ▲
 HT-102



Round top Service Hat

• Polyester construction • Navy material
 • Eyelet vent holes keeps you cool

SIZES: SML 6⁵/₈-6³/₄ M 7¹/₈-7¹/₄
 LRG 7¹/₄-7³/₈ XLRG 7¹/₂-7⁵/₈

\$29⁹⁹ ▲
 HT-103

DRESS CAP COVER

Increases visibility and provides protection from the rain.



Cap not included

\$5⁹⁹ ▲
 HT-40

WINTER WING HAT



\$5⁹⁹ ▲
 HT-42



HT-44W
 WHITE POLICE

HT-44Y
 YELLOW POLICE

\$7⁹⁹

HT-43W
 WHITE SECURITY

HT-43Y
 YELLOW SECURITY

CALL TO ADD YOUR OWN PATCHES

Tel: (877) 643-1100 ---- Toll Free
 Fax: (877) 700-4477 ---- Toll Free

(818) 341-1500 (US & NON US calls)
 (818) 341-0015 (US & NON US calls)

Phone Ordering Only
 M-F 7:30am - 5:00pm PST
 Sat 9am - 2pm PST

REFLECTIVE SECURITY VESTS



**ONE SIZE
FITS ALL**

MSRP
\$19.95

PRICE
REDUCTION
NOW ONLY
\$9.99

- SV-10 Orange without ID
- SV-29 Green without ID
- SV-28 Red without ID



- SV-15 Red with ID
- SV-17 Green with ID
- SV-11 Orange with ID

Call about adding your own text for only \$17.49!

REFLECTIVE DUTY VESTS



Back View

Durable midnight blue mesh construction with fluorescent trim and reflective silver stripes.

Includes mic clip, pen pocket and inside pocket

Adjustable
Velcro® Sides

\$14.99



- SV-09 Plain
- SV-12 Security
- SV-13 Sheriff
- SV-14 Traffic Control
- SV-16 Police

Sizes: Small - 5XL

*Police and Sheriff vests require proof of occupation.

REFLECTIVE SAFETY VESTS



Back View

Reflective lime green vests ensures high visibility in all traffic conditions.

**ONE SIZE
FITS ALL
\$9.99**

Call about adding your own text for only \$17.49!



- SV-18 Plain
- SV-19 Security
- SV-20 Traffic Control
- SV-07 Safety
- SV-08 Parking

All prices subject to change. Any pictorial or typographical errors subject to correction when an order is placed.

Proof of occupation is required for purchase of any law enforcement items.

UAW WILL MATCH COMPETITORS PUBLISHED PRICES

46 REFLECTIVE VESTS

REFLECTIVE EMERGENCY VESTS

ONE SIZE FITS ALL Reflective vests ensure high visibility in all conditions.

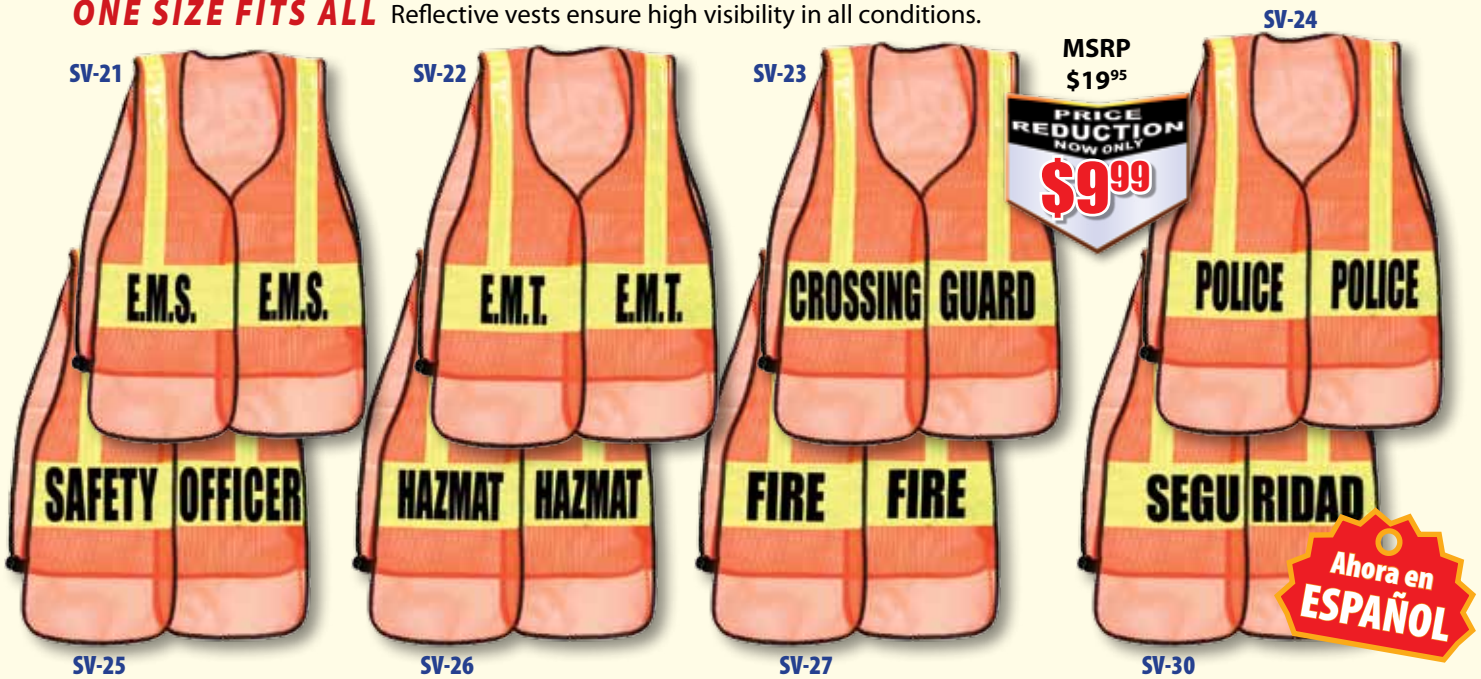

REFLECTIVE SAFETY VESTS

- Class 2 safety vest • Lime mesh • Surveyors type • Reflective Fabric 8903 over contrasting orange stripe • Mesh with partial solid front • Tab/radio/mic holder each shoulder • 3" Velcro adjustment on front for fit • Safety harness/ back D ring pass through opening on back • Phone/radio hold down velcro closure flap • Four front pockets and one inside pocket • Zipper front



SV-31: Plain

(Radio & pens not included)

REFLECTIVE DUTY VESTS

• Each vest has the same text on both front and back of the vest.



SHERIFF SV-34

SECURITY SV-32

PLAIN SV-36

TRAFFIC CONTROL SV-35

\$14.99



FIRE SV-37

Tel: (877) 643-1100 ---- Toll Free
 Fax: (877) 700-4477 ---- Toll Free

(818) 341-1500 (US & NON US calls)
 (818) 341-0015 (US & NON US calls)

Phone Ordering Only
 M-F 7:30am - 5:00pm PST
 Sat 9am - 2pm PST

FACTORY DIRECT SYNTHETIC LEATHER GEAR

SYNTHETIC LEATHER DUTY GEAR BELT COMBO



Adjustable two sizes up or down

Available in even sizes: 30" - 60"
 Sizes 44-48, add \$2.00 Sizes 50-60 add \$4.00

\$69⁹⁹ SLC-01 ▲

- A- Duty-belt and belt buckle
- B- Handcuff Holder
- C- Stainless Steel Handcuffs
- D- Pepper Spray

- E- Pepper Spray Holder
- F- LED Flashlight
- G- Ring Flashlight Holder
- H- Set of 4 Keepers

SYNTHETIC LEATHER DUTY GEAR ACCESSORIES

2 1/4" Duty Belt



▲ SL-01
\$12⁹⁹

Adjustable two sizes up or down
 Available in even sizes: 30" - 60"
 Sizes 44-48, add \$2.00 Sizes 50-60 add \$4.00

Single Handcuff Holder



▲ SL-03
 Velcro® closure
\$9⁹⁹

Double Handcuff Holder

▲ SL-04
 Velcro® closure
\$9⁹⁹

Large Pepper Spray Holder



▲ SL-07
 Velcro® closure
\$9⁹⁹

Small Pepper Spray Holder



▲ SL-05
 Velcro® closure
\$9⁹⁹

Set of 4 Keepers



▲ Hidden snap: SL-17
 Nickel snap: SL-18
\$6⁹⁹

Grip Flashlight Holder



▲ SL-21
 Fits Stinger Flashlight
\$9⁹⁹

Ring Flashlight Holder



\$4⁹⁹ ▲

Black snap: SL-19

30% LIGHTER THAN LEATHER GEAR!

All prices subject to change. Any pictorial or typographical errors subject to correction when an order is placed.
 Proof of occupation is required for purchase of any law enforcement items.

UAW WILL MATCH COMPETITORS PUBLISHED PRICES

FACTORY DIRECT SYNTHETIC LEATHER GEAR

SYNTHETIC LEATHER GEAR ACCESSORIES

Expandable Baton Holder



▲ SL-10
\$9⁹⁹

Ring baton holder



▲ Black snaps: SL-13
▲ Nickel snaps: SL-14
\$4⁹⁹

Double Magazine Holder



▲ SL-23
Hidden snaps
\$9⁹⁹

Double Speed Loader Case



▲ SL-02
Hidden snaps
\$9⁹⁹

Radio Holder



\$9⁹⁹ ▲ SL-11
Velcro®

Key Holder



\$7⁹⁹ ▲ SL-15
Velcro®

Mini-Flashlight Holder



\$9⁹⁹ ▲ SL-22
Velcro®

Mini-Flashlight Holder



▲ SL-20
\$6⁹⁹

Glove Holder



▲ Velcro®: SL-30
▲ Nickel snap: SL-31
\$9⁹⁹

Gun Holster

Made to fit the following frames:

- 4 or 6 inch revolver
- 357 magnum
- 38 revolver
- 44 magnum
- 45 long colt



\$29⁹⁹

▲ HL-10



Universal Radio Holder



\$9⁹⁹
SL-26

BASKET WEAVE LEATHER BADGE HOLDER WITH CHAIN AND CLIP BACK



▲ L-18
\$9⁹⁹

FACTORY DIRECT SYNTHETIC LEATHER GEAR

SYNTHETIC LEATHER GEAR ACCESSORIES

Ring Flashlight Holder



\$7⁹⁹

Brass snap: SL-119G
Black snap: SL-19
Nickel snap: SL-119N

Ring baton holder



\$7⁹⁹

Brass snaps: SL-113G
Black snaps: SL-13
Nickel snaps: SL-113N

Double Magazine Holder



\$9⁹⁹

SL-104G Brass snaps
SL-123N Nickel snaps

Single Handcuff Holder



\$9⁹⁹

SL-103G Brass snap
SL-103N Nickel snap

Large Pepper Spray Holder



\$9⁹⁹

SL-107G Brass snap
SL-107N Nickel snap

Small Pepper Spray Holder



\$9⁹⁹

SL-105G Brass snap
SL-105N Nickel snap

Set of 4 Keepers



\$6⁹⁹

Brass snap SL-117G
Hidden snap SL-17
Nickel snap SL-117N

Universal Radio Holder



\$14⁹⁹

Brass snap SL-126G
Black snap SL-26
Nickel snap SL-126N

2 1/4" SYNTHETIC LEATHER DUTY BELTS

\$19⁹⁹

Basket weave

BSL-101G Brass Buckle
BSL-101N Nickel Buckle

Available in even sizes: 30" - 60"

For sizes 44-48, add \$4.00 for
sizes 50-60 add \$7.00



\$19⁹⁹

Plain leather

PSL-201N Nickel Buckle

PSL-201G Brass Buckle

All prices subject to change. Any pictorial or typographical errors subject to correction when an order is placed.
Proof of occupation is required for purchase of any law enforcement items.

UAW WILL MATCH COMPETITORS PUBLISHED PRICES

BASKET-WEAVE LEATHER GEAR

DUTY BELT COMBO

\$69⁹⁹
CB-01 ▼



Adjustable two sizes up or down

Available in even sizes: 30" - 60"
Sizes 44-48, add \$2.00 Sizes
50-60 add \$4.00

A- Duty-belt and belt buckle
B- 3-D Cell Flashlight
C- Flashlight Ring Holder
D- Set of 4 Keepers

E- Stainless Steel Handcuffs
F- Handcuff Holder
G- Pepper Spray
H- Pepper Spray Holder

BASKET-WEAVE LEATHER ACCESSORIES

Collapsible Baton Holder



L-12
\$9⁹⁹

Easy access baton Holder

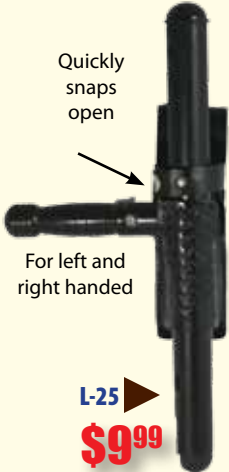

L-25
\$9⁹⁹

Collapsible Baton Holder



L-13
\$4⁹⁹

Expandable Baton Holder



L-10
\$9⁹⁹

Small Pepper Spray Holder



L-05
\$6⁹⁹

Large Pepper Spray Holder



L-07
\$7⁹⁹

Radio holder with Velcro strap



L-11
\$7⁹⁹

Plain leather open handcuff holder



PL-04
\$7⁹⁹

Badge holder w/ chain & clip back



L-18
\$9⁹⁹

Round badge holder with clip



L-08
\$6⁹⁹

Fits star and round badges

Oval badge holder with clip back



L-06
\$6⁹⁹

Fits standard and Federal size badges

Alarm Holder



L-27
Inside:
2 1/4" x 3 1/4" x 3/4"
Button opening
\$9⁹⁹

Universal Radio Holder
L-26
\$9⁹⁹

*Badges not included. See pages 71 - 80

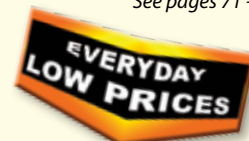

BASKET-WEAVE LEATHER GEAR

2 1/4" DUTY BELT

Sam Brown Style Duty Belt



L-01

Genuine Leather

\$19⁹⁹

Available in even sizes: 30" - 60"

For sizes 44-48, add \$4.00 for sizes 50-60 add \$7.00

1 1/2" TROUSER BELT



L-09

Genuine Leather

\$7⁹⁹

See more duty belts on page 55

1 3/4" TROUSER BELT

Genuine Leather



L-31

\$8⁹⁹

Available in even sizes: 28" - 60"

For sizes 44-48 add \$2.00 for sizes 50-60 add \$3.00

1 1/2" INNER-BELT



L-39

Genuine Leather

\$9⁹⁹

No buckle Velcro closure

BASKET-WEAVE LEATHER ACCESSORIES

Single magazine Holder



L-22

\$9⁹⁹

Double magazine Holder



L-23

\$9⁹⁹

Double Speed loader case holder



L-02

\$9⁹⁹

Key chain Holder



L-15

\$5⁹⁹

Ring flashlight Holder



L-19

\$3⁹⁹

Grip flashlight Holder



\$5⁹⁹

L-21

Set of 4 keepers



\$3⁹⁹

L-17

• 4 Keepers with hidden snaps

• Basket weave universal glove holder with Velcro closure

Plain leather ID holder

\$9⁹⁹ ID-01

- Police/Security
- Event management
- Media pass
- VIP pass - Event Pass
- Luggage Tags

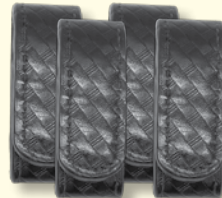

L-42

\$4⁹⁹



L-30

\$9⁹⁹



Single Handcuff holder

L-03

\$6⁹⁹

• Basket weave universal radio holder



\$9⁹⁹

L-26 BASKET WEAVE

All prices subject to change. Any pictorial or typographical errors subject to correction when an order is placed.

Proof of occupation is required for purchase of any law enforcement items.

UAW WILL MATCH COMPETITORS PUBLISHED PRICES

FACTORY DIRECT PLAIN LEATHER GEAR

PLAIN LEATHER BELTS

See NEW ITEMS section for more belts

2¼" Duty-Belt

Genuine Leather

\$19⁹⁹ PL-41

Available in even sizes: 28" - 60"
add \$2.00 for 46-50; add \$3.00 for 52-60



1¾" Trouser Belt

Genuine Leather

\$9⁹⁹ PL-31

Available in even sizes: 28" - 60"
add \$2.00 for 46-50; add \$3.00 for 52-60



1½" Trouser Belt

Genuine Leather

\$7⁹⁹ PL-21

Available in even sizes: 28" - 60"
add \$2.00 for 46-50; add \$3.00 for 52-60



PLAIN LEATHER ACCESSORIES

Handcuff Holder with Detachable key ring

Ring Flashlight Holder

Grip Flashlight Holder

Small Pepper Spray Holder

Large Pepper Spray Holder

Radio Holder



PL-20 \$9⁹⁹

PL-19 \$5⁹⁹

PL-08 \$9⁹⁹

PL-05 \$9⁹⁹

PL-06 \$9⁹⁹

PL-11 \$9⁹⁹

Open Handcuff Holder



PL-04 \$7⁹⁹



Gun Holsters

PL-14 \$29⁹⁹

- Fits:
- 4" or 6" revolver
 - 357 magnum
 - 38 revolver
 - 44 magnum
 - 45 long colt

Single Handcuff Holder



PL-03 \$9⁹⁹

Set of 4 Keepers



PL-17 \$5⁹⁹

Key ring Holder



PL-15 \$6⁹⁹

Double Magazine Holder



PL-07 \$9⁹⁹

FACTORY DIRECT NYLON GEAR

DUTY BELT COMBO

\$69⁹⁹

PL-01

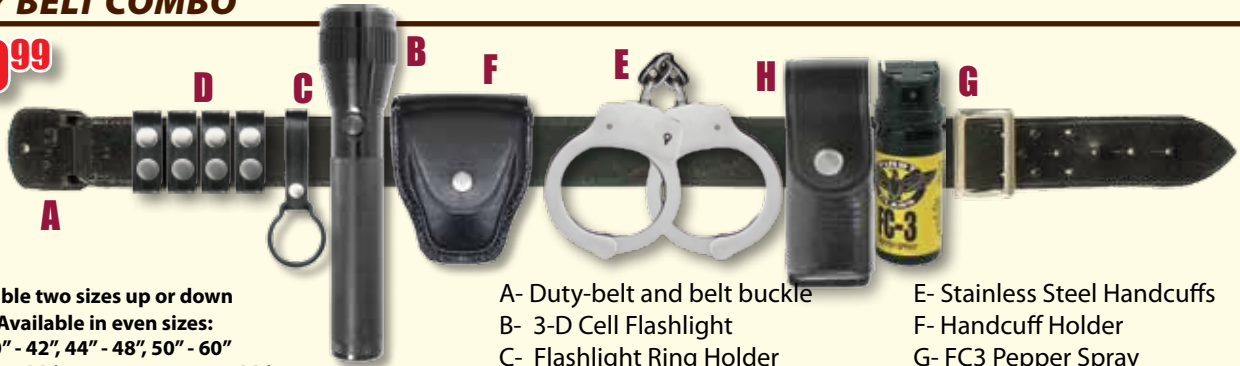

Adjustable two sizes up or down
Available in even sizes:
30" - 42", 44" - 48", 50" - 60"
Sizes 44-48, add \$2.00 Sizes 50-60 add \$4.00

- A- Duty-belt and belt buckle
- B- 3-D Cell Flashlight
- C- Flashlight Ring Holder
- D- Set of 4 Keepers
- E- Stainless Steel Handcuffs
- F- Handcuff Holder
- G- FC3 Pepper Spray
- H- Pepper Spray Holder

NYLON DUTY BELT COMBO

CP-01
\$49⁹⁹



Sizes: S (28-32), M (34-36), L (38-40), add \$5.00 for 1XL (42-46) & 2XL (48-52), add \$9.00 for 3XL (54-56) & 4XL (58-60)

- A- Duty-belt and belt buckle
- B- 3-D Cell Flashlight
- C- Flashlight Ring Holder
- D- Set of 4 Keepers
- E- Stainless Steel Handcuffs
- F- Handcuff Holder
- G- FC3 Pepper Spray
- H- Pepper Spray Holder

RESILIENT & WATER RESISTANT NYLON BELTS

MSRP
\$19⁹⁹

2 1/4" DUTY-BELT WITH CLASP

Available in sizes
Small - 4XL

1 1/2" VELCRO DUO-BELT

add \$3.00 for XL - 2 XL;
add \$7.00 for 3XL - 4XL

\$7⁹⁹

N-02



add \$3.00 for XL - 2 XL;
add \$7.00 for 3XL - 4XL

- Small = 26-30"
- Med = 32-36"
- Large = 38-42"
- XL = 44-48"
- 2XL = 50-54"
- 3XL = 56-60"
- 4XL = 62-64"



\$6⁹⁹

N-04

Belt adjusts two sizes providing for extended wear

CARRYALL DUTY GEAR BAG

- Organizes all your duty needs
- Durable black nylon construction provides protection for all your gear
- Bag top includes two inside zippered pouches and six pen/pencil slots
- Three exterior open pockets and two zippered end pockets
- Size: 12" H x 18 1/2" W x 7 1/2" D

\$19⁹⁹

BAG-01



Items in bag are not included.

WORK GLOVES

- 100% cotton gloves
- Non-Slip grip surface
- One size fits all
- Sold as 1 pair



\$2⁴⁹

per pair

GL-02

All prices subject to change. Any pictorial or typographical errors subject to correction when an order is placed.
Proof of occupation is required for purchase of any law enforcement items.

UAW WILL MATCH COMPETITORS PUBLISHED PRICES

NYLON DUTY BELT ACCESSORIES

<p>Baton Holder</p>  <p>N-10 \$7⁹⁹</p>	<p>Baton Holder</p>  <p>N-13 \$5⁹⁹</p>	<p>Gun Holster</p>  <p>Fits: 4" or 6" revolver 357 magnum 38 revolver 44 magnum 45 long colt</p> <p>N-14 \$19⁹⁹</p>	<p>Ring Flashlight Holder</p>  <p>\$1⁹⁹ N-19</p>	<p>Pepper Spray Holders</p> <p>Large</p>  <p>N-07 \$5⁹⁹</p> <p>Small</p>  <p>N-05 \$5⁹⁹</p> <p><i>Also fits FL-45 flashlights</i></p>	
<p>Double Magazine Holder</p>  <p>\$9⁹⁹ N-23</p>	<p>Double Speed Loader Case</p>  <p>\$9⁹⁹ N-11</p>	<p>Key Holder</p>  <p>\$4⁹⁹ N-15</p>	<p>Set of 4 Keepers</p>  <p>\$2⁹⁹ N-21</p>	<p>Radio Holder</p>  <p>\$8⁹⁹ N-25</p>	<p>Handcuff Holders</p> <p>Single</p>  <p>\$5⁹⁹ N-03</p> <p>Double</p>  <p>\$6⁹⁹ N-31</p>
<p>Glove holder</p>  <p>\$9⁹⁹ Nylon: N-30</p>	<p>Universal Radio Holder</p>  <p>\$9⁹⁹ N-26</p>	<p>Stinger Flashlight Holder</p>  <p>\$9⁹⁹ N-27</p>	<p>Key Holder</p>  <p>\$3⁹⁹ N-30</p>		
<p>Double Magazine Holder</p>  <p>\$9⁹⁹ N-123</p>	<p>2 oz Pepper Spray Holder</p>  <p>\$9⁹⁹ N-105</p>	<p>4oz Pepper Spray Holder</p>  <p>\$9⁹⁹ N-107</p>	<p>Handcuff Holder</p>  <p>\$9⁹⁹ N-104</p>	<p>Radio Holder</p>  <p>\$8⁹⁹ N-25</p>	
<p>Baton Holder Use on left or right side</p>  <p>\$9⁹⁹ N-125</p>	<p>Single Handcuff Holder</p>  <p>\$9⁹⁹ N-103</p>	<p>Single Handcuff Holder With detachable key ring</p>  <p>\$9⁹⁹ N-203</p>	<p>Mini Flashlight Holder</p>  <p>\$9⁹⁹ N-20</p>		

2 1/4" VELCRO BUCKLELESS LEATHER DUTY BELT

Our 100% Genuine leather buckleless leather Velcro® belts offer a professional look. They feature easy to use hidden Velcro® fasteners.

EMBOSSED UNDER-BELT



MSRP \$39⁹⁵ **\$19⁹⁹**
LVEL-01

add \$10.00 for 48-60"

Available in sizes
Small - 4XL

Small = 28-34"
Med = 36-38"
Large = 40-42"
XL = 44-46"
2XL = 48-50"
3XL = 52-54"
4XL = 56-60"

CROSS STITCHED DUTY BELT



MSRP \$39⁹⁵ **\$19⁹⁹**
PLVEL-01

add \$10.00 for 48-60"

1 1/2" CLASSIC BROWN TROUSER BELT

\$9⁹⁹ Full grain contrast stitched leather belt with brass buckle.

Available in sizes
Small - 2XL

Small = 28-32"
Med = 34-38"
Large = 40-46"
XL = 48-52"
2XL = 54-60"

For sizes 42-50 add \$5.00
For sizes 52-60 add \$10.00



Genuine Leather

LB-01

DUTY BELTS



SAM BROWN STYLE DUTY BELT

2 1/4"

ALL 100% LEATHER BELT

Available in even
sizes: 30" - 60"

2 1/4" L-01

\$19⁹⁹

For sizes 42-60
add \$5.00



SAM BROWN STYLE DUTY BELT

2 1/4"
SYNTHETIC LEATHER BELT

\$14⁹⁹ For sizes 44-60 2 1/4" L-102
add \$5.00



BASKET WEAVE LEATHER BELT

2 1/4"

\$19⁹⁹ 2 1/4" L-101

For sizes 42-60
add \$5.00



BASKET WEAVE LEATHER BELT

2 1/4"

ALL 100% LEATHER BELT

For sizes 44-60
add \$5.00

\$29⁹⁹

2 1/4" L-100

All prices subject to change. Any pictorial or typographical errors subject to correction when an order is placed.

Proof of occupation is required for purchase of any law enforcement items.

UAW WILL MATCH COMPETITORS PUBLISHED PRICES

GUN HOLSTERS



BASKET WEAVE HOLSTER

Made to fit the following frames:

- 4" or 6" revolvers
- 357 magnum
- 38 Revolver
- 44 Magnum
- 45 Long Colt

\$19⁹⁹

HL-10

A limited number of left handed holsters available



NYLON GUN HOLSTER

Made to fit the following frames:

- 4" or 6" Revolver
- 357 Magnum
- 38 Revolver
- 44 Magnum
- 45 Long colt
- Also available in right-handed

\$19⁹⁹

N-14



\$29⁹⁹

BASKET WEAVE HOLSTERS

HL-01

Made to fit:
S&W (Smith & Wesson) Frames
Ruger
Security Six
Speed Six
Police Service Six

HL-02

Made to fit:
Beretta 92

HL-04

Made to fit:
S&W N Frames

1917 Astra-Garcia Astra
Colt-New Service Mod
Taurus 44 Cal

HL-05

Made to fit:
Hi Standard
Mod 9402-9408
Ruger
Security Six
Speed Six
S Police Service Six
S&W
All K&L Frames

LIBERATOR BODY ARMOR

CONCEALABLE BODY ARMOR BY FIRST CLASS

The Liberator Body Armor is for those who demand uncompromising performance and comfort. Utilizing DuPont Kevlar for incredible performance and dependability, the Liberator Series is 30% lighter than current all-Aramid fabric armor, providing an excellent combination of flexibility and comfort. The front, back as well as the sides of the body have protection from firearms.

Specifications:

- Ballistic material: KEVLAR
- Ballistic technology: DuPont
- Protection Level: IIIA
- 6 point elastic and 4 point-point wide wrap with Velcro
- Poly-cotton/aquadyne carrier system
- Soft 6" x 8" Trauma Plate
- Color: Black

Available in chest sizes with regular vest lengths:

- Small (34-36)
- Medium (38-40)
- Large (42-44)
- 1XL (46-48)
- 2XL (50-52)
- 3XL (54-56)
- 4XL (58-60)

For Ballistic Capabilities of this body armor, please visit our web site at www.uniforms4all.com

Sizes available: Small - 4XL

- For 2XL add 10%
- for 3XL add 15%
- for 4XL add 20%

\$299⁹⁹

ARFC-01

You must check your own state for laws and regulations on body armor usage.

Proof of occupation must be supplied with your order.



UNIVERSAL GUN HOLSTERS



- Nylon universal leg holster with standard double leg strap and magazine pouch
- Fits all medium/ large handguns

\$19⁹⁹

◀ HL-07



- Nylon universal leg holster with standard double leg strap and magazine pouch
- Fits all medium/ large handguns

\$19⁹⁹

◀ HL-11



- Nylon universal holster with single leg strap
- Fits all medium/ large handguns

\$19⁹⁹

◀ HL-09



- Nylon universal holster fits all medium/ large handguns

\$19⁹⁹

◀ HL-06



- Basket weave universal holster fits all medium/ large handguns

\$19⁹⁹

◀ HL-12

POLYMER PISTOL POUCHES

- Chemical and heat-resistant polymer
- Adjustable tension, fits belts from 1-1/4" to 2-1/4"
- Made in the USA

\$19⁹⁹



- MH-59166 Glock Dbl Stack 9mm/.40
- MH-59167 Dbl Stack 9mm/.40
- MH-59168 Glock Dbl Stack .45

5.11 THUMBDRIVE™ GUN HOLSTERS



The ThumbDrive™ is a safe and fast drawing Level II handgun holster available on the market. It features the exclusive patent-pending thumb-activating removable Chop-Block™ which secures your weapon at all times. This feature prevents removal during a weapon retention struggle.

- Field tested by Viking Tactics™
- Reinforced construction for increased weapon retention
- Includes adjustable belt slide, paddle and removable Chop-Block™
- Engineered by Blade-Tech™
- Available in Right-Hand Only

- GH-50023 Glock 17/22
- GH-50026 Glock 34/35
- GH-50030 Glock 19/23

\$49⁹⁹



All prices subject to change. Any pictorial or typographical errors subject to correction when an order is placed. Proof of occupation is required for purchase of any law enforcement items.

UAW WILL MATCH COMPETITORS PUBLISHED PRICES

CHAIN-LINKED HANDCUFFS

- Nickel plated steel for longevity and maximum durability
- 2 inch chain restricts flexibility
- Ratchet jaw • Double locking
- 2 keys



\$9⁹⁹
 ▲ HC-01

HINGED HANDCUFFS

- Stainless steel • Double locking • Ratchet jaw • 2 keys



\$19⁹⁹
 ▲ HC-02

KEY CHAIN HANDCUFF KEY

Compatible with all handcuffs on this page



(See NEW ITEM section for more keys)

\$2⁹⁹
 ▲ KHC-01

EASY CUFFS

Durable construction
 Easily slip these on assailant.

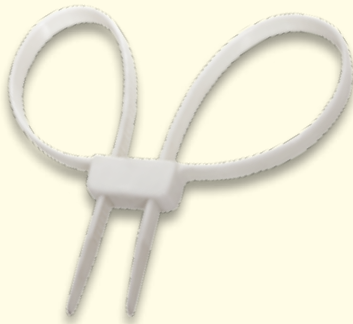

\$1⁹⁹
 ▲ HC-04

LEG CUFFS BY PEERLESS

- Nickel plated steel • Double safety lock for additional security
- Special made ditched jaws • Kick, pick, walk & run proof
- 15 inch linked, welded chain • Fits any size ankle • 2 keys



\$39⁹⁹
 ▲ HCP-702

Leg cuffs by FIRST CLASS an imported version

\$19⁹⁹ ▲ HC-03

PEERLESS 700 & 700P CHAIN CUFFS



Nickel Finish

Black Carbon Steel/Pentrate

- New spun rivet construction increases the strength and durability of all rivet points, particularly the single strand or jaw rivet point
- Profiled edges minimize the risk of tissue and nerve injury
- Continuously used by correctional officers, F.B.I. Agents, US Marshall Service Personnel, and the military
- Nickel Finish or Black in Carbon steel Pentrate
- 2 keys • Double locking
- Weight: 10 oz.

Lifetime Warranty for Manufacturer's Defects

\$29⁹⁹ ▲ HCP-701
 Black Carbon Steel/Pentrate

\$29⁹⁹ ▲ HCP-700
 Nickel Finish

WAIST HANDCUFF CHAIN



- Stainless steel
- Fits: up to 56"

\$39⁹⁹ each

▲ HC-05

LAW-N-FORCE HANDCUFFS

- Stainless steel • Double locking • Ratchet jaw • 2 keys
- LIFETIME WARRANTY**



COLORED HANDCUFFS

- Stainless steel • Double locking • Ratchet jaw • 2 keys



HC-11-O ORANGE HC-11-P PINK HC-11-Y YELLOW HC-11-R RED

HANDCUFF KEYS

THESE KEYS OPEN ALL HANDCUFFS FEATURED IN THIS CATALOG AND PEERLESS BRAND HANDCUFFS



KHC-02
\$3.99 ea



KHC-03
\$3.99 ea



KHC-04
\$4.99 ea

Able to use your own key



KHC-05
\$4.99 ea

Able to use your own key



KHC-06
\$4.99 ea



KHC-07
\$4.99 ea

Key ring holder

ASP CHAIN HANDCUFFS

ASP chain handcuffs provide a major advance in both the design and construction of wrist restraints. Frame geometry is the result of extensive computer modeling and simulation analysis. Strength potential has been maximized through use of an interlocking unitized frame. The cuff structure is forged from high strength stainless steel on custom built, high speed, progressive dies. Each restraint is then over molded with ordinance grade polymer under 75 tons of pressure. The lock assembly is unitized and replaceable.

- Flat contact surface
- Keyway on each side
- Hand welded stainless chain

HC-15
\$34.99

Includes 1 free nylon hand cuff holder (N-03)



All prices subject to change. Any pictorial or typographical errors subject to correction when an order is placed. Proof of occupation is required for purchase of any law enforcement items.

UAW WILL MATCH COMPETITORS PUBLISHED PRICES



LEATHER ID HOLDERS & WALLETS

\$14⁹⁹
ID-12

Basket weave leather wallet with shield badge and ID holder

RECESSED
BADGE
HOLDERS



\$14⁹⁹

Basket weave leather wallet and star badge and ID holder

ID-13



\$14⁹⁹

Plain leather wallet with shield badge and ID holder

ID-15



Plain leather wallet and star badge and ID holder

ID-16



\$14⁹⁹

RECESSED
BADGE
HOLDERS

\$14⁹⁹

RECESSED
BADGE HOLDER



\$14⁹⁹

RECESSED
BADGE HOLDER



ID-11: Basket weave shield badge and ID holder

ID-14: Plain leather shield badge and ID holder

PLAIN LEATHER: ID-19

BASKET WEAVE: ID-20

\$14⁹⁹

PLAIN LEATHER: ID-21
BASKET WEAVE: ID-22



\$14⁹⁹

ID-18: Basket weave round/star badge and ID holder
ID-23: Plain leather round/star badge and ID holder



UAW HIGH QUALITY DURABLE BATONS

Applications: Tactical training, night watchmen, security personnel, etc...



21" EXPANDABLE BATONS

Fully expands to 21 inches. Free nylon holder included.

\$24⁹⁹ BT-07 ▲



26" EXPANDABLE BATONS

Fully expands to 26 inches. Free nylon holder included.

\$19⁹⁹ BT-01 ▲



19½" STRAIGHT PLASTIC BATONS

- Light weight 12.9 oz • 1½" Diameter • Full 19½ inch long • Rubberized handle
- Shaft material: Plastic rubber coated

\$9⁹⁹ BT-12 ▲



24" SPIN HANDLE

Same aluminum baton used by the LAPD!

\$29⁹⁹ BT-03 ▲



24" FIXED HANDLE

- Solid steel encasing • Knurled grip handle has small ridges to aid in gripping

\$27⁹⁹ BT-02 ▲



24" PLASTIC HANDLE

- Durable enough for harsh training • Ideal for training centers • Lifetime warranty

\$9⁹⁹ BT-05 ▲

21" COLLAPSIBLE BATON

- Size: Extended: 21 inches
Closed: 12½"
- Weight: 19¾oz
- Diameter: ¾"
- Shaft Material: Black aluminum tube ASTM-B-429
- Handle surface: Foam rubber grip



\$19⁹⁹ BT-11 ▲

Our batons are only sold to Law Enforcement and Security Officers. You must provide proof of occupation/certification with your order.

All prices subject to change. Any pictorial or typographical errors subject to correction when an order is placed.

Proof of occupation is required for purchase of any law enforcement items.

UAW WILL MATCH COMPETITORS PUBLISHED PRICES

21" & 26" EXPANDABLE BATONS

Our batons are only sold to Law Enforcement and Security Officers. You must provide proof of occupation/certification with your order.



\$9⁹⁹ 21"
BT-08 ▲

• Easy to carry on duty belt • Expands from 8¼" to 21" with just a quick snap with of your wrist • Soft weather resistant foam style grip • Compact design for quick access and use • Locks into extended position

\$9⁹⁹ 26"
BT-09

21" GOLD EXPANDABLE BATON



\$9⁹⁹ 21"
BT-10 ▲

• Easy to carry on duty belt • Expands from 8¼" to 21" with just a quick snap with of your wrist • Soft weather resistant foam style grip • Compact design for quick access and use • Locks into extended position



ASP™ 21" & 26" EXPANDABLE BATONS



\$74⁹⁹ 21"
ASPB-21 ▲

• This ASP Baton is the most tactically sophisticated impact weapon currently available to law enforcement • Tested by the most elite federal teams, it has proven itself "virtually indestructible." • The first choice of the world's most tactically advanced exceptional workmanship & flawless function

\$79⁹⁹ 26"
ASPB-26

BASKET HOLDERS

SYNTHETIC HOLDERS

ASP™ BATON HOLDER



Expandable Baton Holder

\$9⁹⁹

◀ L-10



Expandable Baton Holder

\$9⁹⁹

◀ SL-10



• The ASP Rotating Side Break Scabbard fits all expandable ASP Batons • Black basket weave polymer construction • Retracted or expanded baton may be rapidly presented • Features adjustable belt loop adjustment with 360 degree rotation for added comfort

\$31⁹⁹ For 21" batons
ASPH-21

\$33⁹⁹ For 26" batons
ASPH-26

NYLON BATON HOLDERS

PLAIN LEATHER BATON HOLDERS

Expandable Baton Holder

See page 54 for more Nylon holders

\$7⁹⁹

▶ N-10



Ring Holder



\$3⁹⁹

◀ N-13

Expandable Baton Holder

\$9⁹⁹

▶ PL-10



Easy Access Baton Holder

(for left and right handed use)

\$9⁹⁹

▶ PL-25



Ring Baton Holder



\$3⁹⁹

▶ PL-13

2 PIECE PLASTIC BELT BUCKLE

These buckles are also airport friendly



\$2⁹⁹

BKL-01

▲ Fits any 2 1/4" belt

REPLACEMENT BELT BUCKLES

BRASS



\$2⁹⁹

▲ **BKL-03**

SLIVER



\$2⁹⁹

▲ **BKL-02**

Fits any 2 1/4" belt

LEATHER GLOVES

- Cut resistant
- Lined for maximum warmth
- Available in S - 3XL

GL-01



\$14⁹⁹

1 pair Size: S - 3XL

FINGERLESS LEATHER GLOVES

Unlined fingerless gloves featuring gel pads on fingers and palm made of premium cowhide.

\$9⁹⁹

GL-10



1 pair Size: S - 3XL

Lightweight unlined classic fingerless glove in supple cowhide, perforated panels and adjustable wrist strap.

\$6⁹⁹

GL-09



1 pair Size: S - 3XL

TWO TONE POLYESTER POLO SHIRTS WITH REFLECTIVE STRIPES

ID on front and back in black only

COMING SOON



\$9⁹⁹

PLAIN PS-69

Size: S - 5XL

\$14⁹⁹

SHERIFF PS-69SH

Call about adding your custom ID

\$14⁹⁹

SECURITY PS-69S

\$14⁹⁹

POLICE PS-69P

\$14⁹⁹

EVENT STAFF PS-69E

REVERSIBLE HOODED RAIN COAT WITH ID

- 100% Polyester 300D Oxford with Polyurethane waterproof coating
- Raincoat is reversible to dark navy with polyester taffeta lining.
- Black button front snaps and highly reflective striping.
- ID on front and back (in black text only)

PLAIN JS-49

COMING SOON

\$69⁹⁹

Size: S - 5XL



\$79⁹⁹

with IDs

Call about adding your custom ID

REFLECTIVE RAIN PANTS

- 100% Polyester
- Reflective striping
- Elastic waist

\$19⁹⁹

Size: S - 3XL

Green FP-01



SHERIFF JS-49SH SECURITY JS-49S POLICE JS-49P

All prices subject to change. Any pictorial or typographical errors subject to correction when an order is placed.

Proof of occupation is required for purchase of any law enforcement items.

UAW WILL MATCH COMPETITORS PUBLISHED PRICES

ID/BADGE LANYARDS SETS

- Text embroidered on flat poly webbing • Bottom has a strong metal spring-release clip that swivels to easily display either side of ID • Release clip separates bottom from top
- Top breakaway feature prevents possible strangulation and will not rub on your neck
- Size: 18"L x 3/4"W



Quick-release clasp

99¢ each

PLASTIC ID HOLDERS



25¢

each

IDH-02

Fits IDs: 2 3/4" x 4"

Lanyard colors:

Black, Navy Blue, Sand, Olive Drab

Text colors available:

Black, White, Gold, Royal Blue, Navy Blue, Red, Gray, Yellow, Green, Orange, Light Grey, Dark Grey

Specify lanyard and text color when ordering.



MULTI-FUNCTION TOOL

- Stainless steel folding pliers • Knife
- Socket and screw driver with 10 bits
- Nail tool • Bottle opener • Comes with a nylon carry case



\$9⁹⁹

MT-02

Socket and screw driver set with 10 bits

UAW MULTI TOOL & FLASHLIGHT

- Stainless steel folding pliers • Flashlight • Knife • Socket and screw driver with 10 bits
- Nail tool • Bottle opener
- Comes with a nylon carry case



\$39⁹⁹

MT-01

Socket and screw driver set with 10 bits

Tel: (877) 643-1100 ---- Toll Free
Fax: (877) 700-4477 ---- Toll Free

(818) 341-1500 (US & NON US calls)
(818) 341-0015 (US & NON US calls)

Phone Ordering Only
M-F 7:30am - 5:00pm PST
Sat 9am - 2pm PST

SHIRT STAYS

Keeps shirts neatly tucked



SST-01

Foot loop style
2 per box

SST-02

Shirt Holders
4 per box

SST-03

Y Style Stays
2 per box

▲ **\$6⁹⁹**

How to wear shirt stays

- 1 Dress yourself partially being sure that you are wearing socks that reach at least the mid-calf. Your undergarments should be on as well as the shirt you are planning to wear.
- 2 Clip the shirt stay onto your sock so that it is on the outer part of your leg. Repeat with another shirt stay on the other leg.
- 3 Fasten the other end of the shirt stay to the base of your shirt using the clip. Repeat on the other side as well. You should feel a slight bit of tension from the shirt stay. Otherwise, you will be easily un-tucked.
- 4 Pull up your pants and fasten your belt. Now you are fully dressed.

GUARD DOG PEPPER SPRAY



MSRP
\$14⁹⁹

\$5⁹⁹

GD-03

Size: 2 oz net weight

- Highest grade formula & laboratory tested for no-leak and optimum efficiency
- Easy twist-top makes it quickly accessible when needed - Just Twist and Shoot!

A Stronger and More Powerful 3 Key Ingredients formula!

Active Ingredients: •18% Oleoresin Capsicum (Red Pepper) causes the "burn" factor from the spray • CS Military Tear Gas causes inflammation in the eyes, nose, and mouth • Invisible UV Dye causes an "invisible" dye on the assailants which enables law enforcement to successfully identify the victim in the case the victim attempts to wash off the substance

3-IN-1 18% OC PEPPER SPRAY WITH BUILT-IN KEYCHAIN



MSRP
\$9⁹⁹

\$2⁹⁹

Size: ½ oz net weight

MK-01P ▼

MK-01R ▼



MK-01B ▲

All Our Pepper Sprays are made in the USA!

Check local laws and restrictions for use of pepper spray

SABRE PEPPER SPRAY

SABRE RED IS OVER SIX TIMES HOTTER THAN THE HOTTEST CHILI PEPPER!

- SABRE RED contains approximately 1.33% Major Capsaicinoids!
- SABRE RED contains 10% oleoresin capsicum
- Measures 2,000,000 Scoville Heat Units found to be up to 86% stronger than the competition
- 5x more shots per canister
- Contains UV Marking Dye for suspect identification
- 4 year expiration date up to 2 years longer than most other sprays



1.8 oz

▲ **MK-03**

\$11⁹⁹

EVERYDAY LOW PRICES



3.3 oz

MK-04 ▲

\$14⁹⁹

FIRST CLASS PEPPER SPRAY

Eliminator Foam Pepper Spray

Active Ingredients:
OLEORESIN CAPSICUM 15%



2.0 oz

FC-102

\$8⁹⁹



4.0 oz

FC-104

\$9⁹⁹

First Class Brand Pepper Spray

Active Ingredients:
OLEORESIN CAPSICUM 18%



2.0 oz

FC-03

\$8⁹⁹



4.0 oz

FC-04

\$9⁹⁹



16 oz

FC-16

\$29⁹⁹

All prices subject to change. Any pictorial or typographical errors subject to correction when an order is placed.

Proof of occupation is required for purchase of any law enforcement items.

UAW WILL MATCH COMPETITORS PUBLISHED PRICES

CASIO SHOCK & WATER RESISTANT TIME PIECES

Full descriptions of each watch available on our web site www.uniforms4all.com



DW6900-1V

\$59⁹⁹

◀ WAT-01



AMW320D-9EV

\$59⁹⁹

◀ WAT-06



DW9052-1V

\$59⁹⁹

◀ WAT-02



DW5600E-1V

\$49⁹⁹

◀ WAT-04



DB35H-1AV

\$29⁹⁹

◀ WAT-09



DW290-1V

\$29⁹⁹

◀ WAT-05



AMW320R-1EV

\$59⁹⁹

◀ WAT-07



AMW320R-7EV

\$59⁹⁹

◀ WAT-08



W87H-1V

\$29⁹⁹

◀ WAT-10



WV200A-1AV

\$49⁹⁹

◀ WAT-12



FE10-1A

\$24⁹⁹

◀ WAT-11



LW200-1AV

\$29⁹⁹

◀ WAT-13



LA11WB-1

\$14⁹⁹

◀ WAT-15



F91W-1

\$23⁹⁹

◀ WAT-14



MDV102-1AV

\$59⁹⁹

◀ WAT-16



W800H-1AV

\$19⁹⁹

◀ WAT-17





RYNO GEAR FOOTWEAR

8" TACTICAL PRO ZIPPER BOOTS



- Water resistant leather and durable nylon upper • Slip-resistant rubber outsole
- Side zipper for easy on/off • 6" or 8" ankle height with padded nylon tongue
- Sizes: 6-13 (full sizes only)

◀ **8" High:**
RY-11 (with regular toe)

~~\$199⁹⁹~~
\$49⁹⁹

ARIYA DRESS CASUAL SHOES



See our web site for full details on these brand name casual leather shoes

NEW

\$99⁹⁹

CARING FOR YOUR BOOTS:

- Cleaning the boots: Brush off any excess mud and wash them in clean warm water with a cloth
- Boots should never be forced dried as it will encourage the leather to dry out and crack
- Should the boots become excessively wet, stuff them with newspaper to draw out water. The newspaper should be replaced periodically.
- Boots can be dried by a gentle flow of air from a small fan or by placing them in an upright position in front of the refrigerator.
- After drying, you can use a waterproofing/conditioning substance if desired
- Prolonged application of liquid repellent may cause the leather to become overly flexible.

DANNER ARCADIA 8" TACTICAL BOOTS

- Ideal for action in warmer climates
- Water-resistant Leather
- Smart easy to wear boot (U.S.M.C approved)
- 1000 denier Cordura & a Gore-tex liner to deliver all round performance
- Rugged, Durable Vibram Kletterlift outsole



\$249⁹⁹

Men's Regular RY-15

Sizes: 7-13 (available in 1/2 sizes)

Men's Boots Wide RY-16

Sizes: 9-12 (wide full sizes only)

Women's Boots RY-17

Women's Sizes: 7-19 (available in 1/2 sizes)

8" STRIDER BOOTS



- Water resistant leather and durable nylon construction
- Side zipper for easy on/off
- 8" ankle height with padded nylon tongue
- Slip-resistant rubber outsole
- Sizes: 6-13 (full sizes only)

◀ ~~\$99⁹⁹~~
\$24⁹⁹
RY-03

TACTICAL PURSUIT SHOES

- Modeled for durability and speed
- Water resistant leather and durable nylon construction
- Slip-resistant rubber outsole
- Removable insole
- Sizes: 6-13 (full sizes only)



\$19⁹⁹ ~~\$79⁹⁹~~
RY-21

All prices subject to change. Any pictorial or typographical errors subject to correction when an order is placed. Proof of occupation is required for purchase of any law enforcement items.

8" TROOPER SIDE ZIP BOOT

UPPERBlack Oil Tanned Leather / 1000 Denier Nylon
 CONSTRUCTION.....Goodyear Storm Welt
 LININGDri-Lex(R) Aerospace(R)
 INSOLE.....Single Density Polyurethane Removable
 Footbed /Special EVA Cushion Flex
 MIDSOLE..... Shock Absorbing EVA
 SHANK Engineered Composite
 OUTSOLEGEN EX'M Dual Density Rubber Lug
 SPECIAL FEATURES: Heavy Duty YKK Side Zipper with Velcro Closer



8" High:
RY-7991

\$104⁹⁹



8" WATERPROOF SIDE ZIP BOOT

UPPERBlack Full Grain leather /Black Action Leather
 11200 Denier Nylon
 CONSTRUCTION.....Cement
 LININGTwo Zone Wicking Mesh / Thoro>dri Waterproof
 System, Blood Borne Pathogen Compliant
 INSOLE.....Removable Two Density Polyurethane "SHOCK
 ZONE" Footbed with Air Flow Vents
 SHANKEngineered Composite
 OUTSOLETwo Density Rubber with Integrated EVA
 Impact Pads
 SPECIAL FEATURES:Molded Rubber Heel Stabilizer. *Non-Metallic
 Construction.* Heavy Duty VKK Side Zipper



8" High:
RY-6219

\$83⁹⁹

Both approved by LAPD and LA Sheriff



Buy one pair of these boots and get 1 pair of Vital-ION SO-03 socks free!

5.11 TACTICAL 6" SIDE ZIP BOOT

- A.T.A.C. 6" boots are built with YKK side zippers
- Polishable full-grain leather toes
- Antibacterial and moisture-wicking lining
- 5.11 shock mitigation system and oil/slip resistant outsoles

Available sizes Regular: 4, 5, 6-12,13,14,15



6" High:
RY-12018

\$99⁹⁹



Buy one pair of these boots and get 1 pair of Vital-ION SO-03 socks free!



5.11 TACTICAL 8" SIDE ZIP BOOT

- A.T.A.C. 8" boots are built with YKK® side zippers
- Polishable full-grain leather toes
- Antibacterial and moisture-wicking lining
- 5.11s Shock Mitigation System and oil/slip resistant outsoles
- A.T.A.C. 8" boots also feature a hidden pocket at the top.

Available sizes:
Regular: 4, 5, 6-12,13,14,15

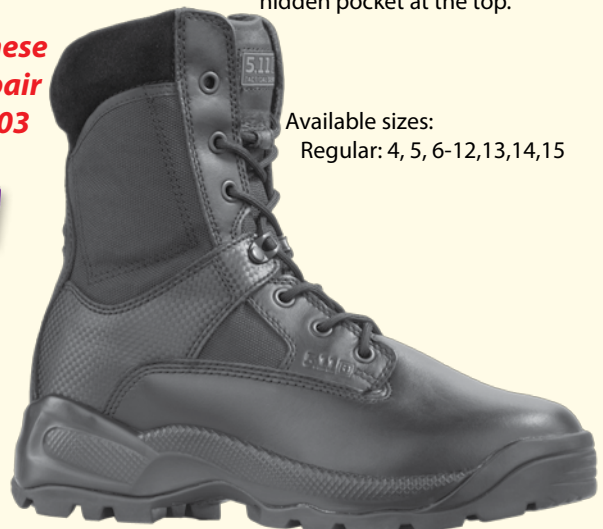

6" High:
RY-12001

\$109⁹⁹

LEATHER DRESS SHOES



~~\$89⁹⁹~~
\$29⁹⁹
 SH-01

- Professional appearance high quality Leather Dress shoes for formal wear.
- Cushioned lining keeps your feet comfortable
- Slip resistance rubber outsole
- Sizes: 6-13 (full sizes only)

HI-GLOSS OXFORD DRESS SHOES

~~\$69⁹⁹~~
\$19⁹⁹
 SH-03



The Oxford Dress Shoes have a high gloss upper that is perfect for formal wear.

- High gloss upper never needs to be shined
- Cushioned lining keeps your feet comfortable
- Slip-resistant polyurethane sole
- Sizes: 6-13 (full sizes only)

DIAMOND BLACK POLISH

Made with the finest waxes available to give a superb and lasting shine as well as nourishing and protecting the leather.



SOCKS

The soft bottom cushion your feet reducing fatigue and adding to your comfort.

3 pairs for only

S0-01 MEN'S QUARTER
\$4⁹⁹



AETREX CREW SOCKS

- Eliminates 99.9% of bacteria, fungi and odor
- Non-Binding yarn with Spandex hugs leg with no restriction
- Hand linked smooth toe seam for extra protection
- Moisture-Guard™ wicking system
- Extra cushioning for comfort

\$9⁹⁹ S0-02
 1 pair Size: M, L & XL



KIWI BLACK POLISH

Easily works into leather and seams using a cloth or brush.

- Extends the life of the shoes
- Gives a natural shine
- Protects with the multi-wax-formula
- 1 1/8 oz.



ANGELUS SHOE WAX POLISH

Angelus Shoe Wax Polish polishes and preserves all smooth leathers and restores color. Goes twice as far as ordinary shoe paste, and polishes twice as fast! It contains the highest grade of waxes and oils, as well as richer colors for restoring faded footwear.



• 3 FL. oz.

SHOE CARE KIT

Includes 1 wood dauber, 1 shine cloth, 2 tins of black wax, 1 100% horse hair brush and 1 storage bag.



All prices subject to change. Any pictorial or typographical errors subject to correction when an order is placed.

Proof of occupation is required for purchase of any law enforcement items.

UAW WILL MATCH COMPETITORS PUBLISHED PRICES

70 FLASHLIGHTS

MAGLITES® FLASHLIGHTS

The Maglite® flashlights are now available with the new MAGLED™ Technology. All Maglite LED flashlights feature Balanced Optics™, combining a highly refined reflector with a quality LED, for a brilliant adjustable beam, and an Intelligent Energy Source Management balancing high brightness with efficient power usage.



3-D Cell LED Flashlights



Size: 12¼" long 2" lens

- 3 Watt LED produces a powerful projecting beam that focuses simply by rotating the head
- Rugged, machined aluminum construction with knurled design
- Anodized inside and out for improved corrosion resistance
- Interchangeable Light Sourcing - use either the installed LED module or Krypton lamp (stored in the tailcap)
- 3 D Cell batteries not included

▲ FL-31 **\$29⁹⁹**

MAGLITES® - RECHARGEABLE FLASHLIGHT SYSTEM



Size: 12¼" long 2" lens

\$99⁹⁹

◀ FL-32

Includes:

- 12V DC Charger
- 120V AC convertor
- Car charger
- Car & home mounting brackets for multiple charging locations
- 5 cell NI-CAD battery

Charging unit



MAGLITES® - DUAL 3 C CELL & RECHARGEABLE LED FLASHLIGHT SYSTEM

• Maglite - ML125 • Output: 193 Lumens • Run time: 25 hours on high or 71 hours on low setting

• Designed to run on (3) C-Cell alkaline batteries or a NiMH rechargeable battery pack • Mag® Multi-Mode Electronic Switch (7 Modes) • NEW! Mag® Beam Alignment System - An adjustment mechanism allowing the user to align the LED module within the center of the focusing vortex • Rugged, machined aluminum construction • Anodized inside and out for improved corrosion resistance • Water and Shock Resistant • Sealed at both ends with high-grade rubber o-rings • Includes Portable Battery Charger, AC Converter and NiMH Battery Pack



Size: 11" long 2" lens



Includes charger system

\$89⁹⁹

▲ FL-67

Tel: (877) 643-1100 ---- Toll Free
Fax: (877) 700-4477 ---- Toll Free

(818) 341-1500 (US & NON US calls)
(818) 341-0015 (US & NON US calls)

Phone Ordering Only
M-F 7:30am - 5:00pm PST
Sat 9am - 2pm PST

5 WATT LED FLASHLIGHTS

- High-grade alluminum alloy with knurled grip • 3 mode switch allows you to choose between high output, low output or flashing output • Bulb: 5W LED • Output: 200 lumens • Run time low: 5 hours
- Run time: high: 2.5 hours • Size: 13¼" long, 2¼" lens Weight: 25 oz

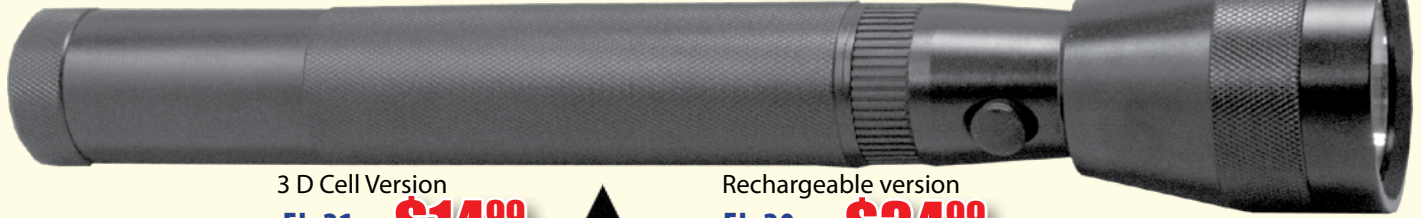

3 D Cell Version

FL-21 \$14⁹⁹

Rechargeable version

FL-20 \$34⁹⁹



Includes:

- 5 watt LED
- 12V DC car charger • 120V AC wall charger
- Rechargeable battery (FL-20 only)



BAT-40 \$9⁹⁹

Replacement battery only

3 & 5 WATT LED FLASHLIGHTS

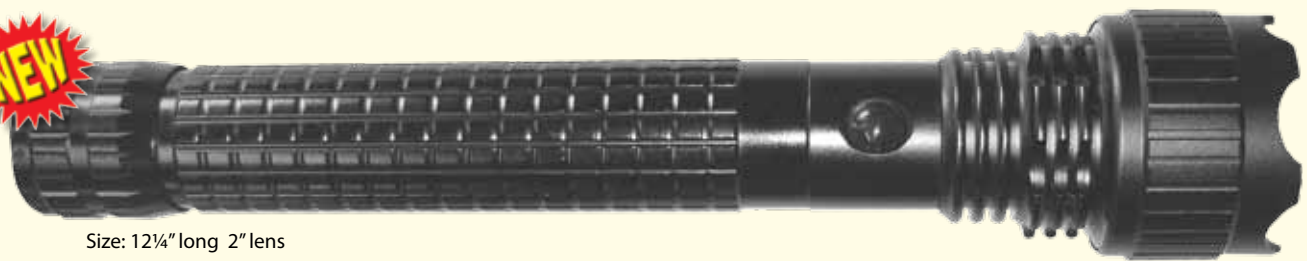

Size: 12¼" long 2" lens

\$34⁹⁹ FL-60 ▲

- 3W LED flashlight uses 3 C cell rechargeable batteries included with charger and case

\$19⁹⁹ FL-61

- 5W LED flashlight uses 3 D cell rechargeable batteries included with charger and case

\$14⁹⁹ FL-62

- 5W LED flashlight uses 3 C cell batteries included with case

2-D & 3-D CELL FLASHLIGHTS

- High-grade aluminum • Adjustable light projection • Extra bulb in tail cap • Light-weight knurled grip



▲ **FL-01** Size: 12" long 2" lens

\$9⁹⁹



▲ **FL-02** Size: 10¾" long 1¾" lens

\$8⁹⁹

Purchase the 2-D cell for roadside emergencies.



All prices subject to change. Any pictorial or typographical errors subject to correction when an order is placed. Proof of occupation is required for purchase of any law enforcement items.

UAW WILL MATCH COMPETITORS PUBLISHED PRICES

72 FLASHLIGHTS

2-AA CELL MINI LED MAGLITES®

- Features a powerful 3 Watt LED in a compact size
- Focusing beam lens
- Easily converts to candle mode by unscrewing the flashlight head
- Includes belt holder and 2 AA batteries

Size: 6½" long ¾" lens

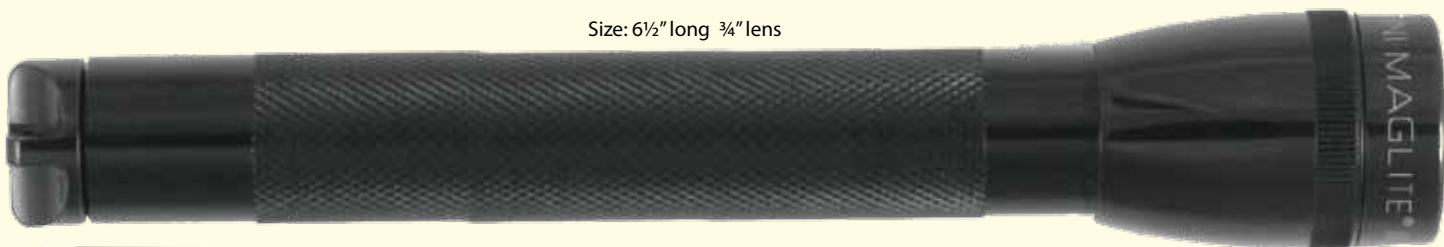

Nylon belt holder

▲ FL-33 **\$19⁹⁹**



6 LED ALUMINUM FLASHLIGHTS

- Side button turn on/off
- 6 LEDs
- Includes 2 lithium batteries & nylon case



Size: 5½" long ¾" lens

\$9⁹⁹

▲ FL-23

MULTI-FUNCTION SAFETY TOOL

- Highly visible bright beacon
- Visible to 550 yards
- Flash rate 60 per minute
- Requires 2AA batteries (not included)



\$9⁹⁹ each
FL-36

MAGLITE XL-100 TACTICAL LED LIGHT

Provides push-button tail cap switch coupled with the 5 different modes: Normal (adjustable brightness with memory), Strobe (adjustable rate). Signal (on/off with a twist of the wrist), SOS (morse code signal for distress) and Nite-Lite.

- Control 5 modes with your wrist
- Push-button tail cap
- Machined aluminum body
- Corrosion resistant
- Water and shock-resistant
- Both ends with high-grade rubber o-rings and lip seals
- ANSI/NEMA FL1-2009 compliant
- Uses 3 AAA batteries (included)
- 1" H x 1" D x 4-7/8" L. 4 oz.



Rotate left or right for variable power levels and access to different modes



\$39⁹⁹ FL-37



Tel: (877) 643-1100 ---- Toll Free
Fax: (877) 700-4477 ---- Toll Free

(818) 341-1500 (US & NON US calls)
(818) 341-0015 (US & NON US calls)

Phone Ordering Only
M-F 7:30am - 5:00pm PST
Sat 9am - 2pm PST

STREAMLIGHT 75813 STINGER DS® C4 LED FLASHLIGHT

- Dual Switch Technology – Access 3 variable lighting and strobe mode from tail or head switch
- Rechargeable battery • 50,000 hour lifetime C4® LED impervious to shock • Deep-dish parabolic reflector produces long range targeting beam with optimal peripheral illumination • 17,000 candela (peak beam intensity) and 180 lumens output • Runtime: High – Up to 2 hours; Medium – Up to 3.75 hours; Low – Up to 7.25 hours; Strobe – Up to 5.5 hours • Body: aircraft aluminum with non-slip rubberized comfort grip
- Unbreakable Polycarbonate lens with scratch-resistant coating • O-Ring sealed construction • 3-cell, 3.6 Volt Nickel cadmium sub-C battery is rechargeable up to 1000 times • Includes Anti-roll Ring and battery
- Fits existing Stinger chargers • 10 hours to recharge on 100V, 120V, 230V or 240V AC



Top Button



Rear Button

See web site for full information

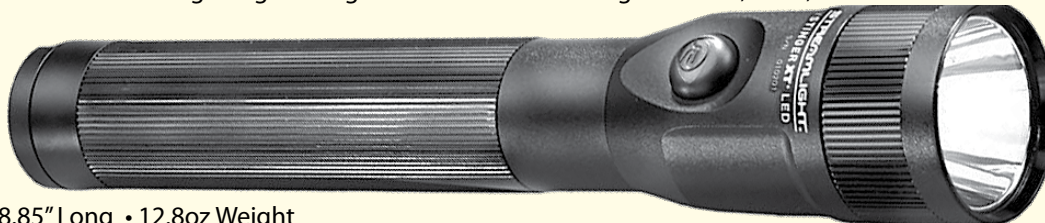

• 8.85" Long • 12.8oz Weight

Buy this flashlight and get a nylon holder free N-27

\$119⁹⁹ FL-75813

\$109⁹⁹ FL-75811

AC/DC Rechargeable Includes battery

AC Only Rechargeable Includes battery

FL-75175 Battery for above flashlight **\$19⁹⁹**



C4 LED UPGRADE KIT

- Making the light 2-3x brighter • Includes facecap assembly, retaining ring and C4 LED with switch assembly • Upgrade changes older LEDs to the newer super bright LEDs

\$24⁹⁹
FL-75768



STREAMLIGHT 75863 STINGER DS® C4 LED HP FLASHLIGHT

DUAL SWITCH TECHNOLOGY Access any of the 3 variable lighting modes and strobe via the end cap or the independently functioning top mounted switch

- High performance flashlight delivers very high intensity • Shock-proof • 50,000 hr. lifetime
- C4 LED increases the brightness w/ up to 3X more light intensity • Output: High: 48,000 candela (peak beam intensity); 200 lumens Medium: 24,000 candela (peak beam intensity); 100 lumens Low: 11,000 candela (peak beam intensity); 50 lumens • Deep-dish parabolic reflector produces a long range targeting beam w/ optimal peripheral illumination • Optimized electronics provides regulated intensity



\$129⁹⁹

FL-75863
AC/DC

\$119⁹⁹

FL-75861
AC Only

Charging Station



Buy this flashlight and get a nylon holder free N-27



All prices subject to change. Any pictorial or typographical errors subject to correction when an order is placed. Proof of occupation is required for purchase of any law enforcement items.

UAW WILL MATCH COMPETITORS PUBLISHED PRICES

LED FLASHLIGHTS - BRIGHT, STRONG, AFFORDABLE

THE NECESSITIES OF LIFE AT WORK, AT HOME, IN THE CAR . . .

TX-1 LED FLASHLIGHT

1 WATT LED Flashlight



- Machined aircraft aluminum body
- Intense 1 Watt LED
- Output: 45 lumens
- Continuous run time of 3 hours
- Includes 3 AAA batteries
- Size: 5 3/4" long 1" lens

▲ FL-26
\$9⁹⁹

TX-2 LED FLASHLIGHT

SUPER 3WATT FLASHLIGHT



- Rugged, black anodized finish provides resistance against corrosion
- Output: 100 lumens
- Rear button on-off
- Continuous run time of 2 hours
- Includes 2 CR123A batteries
- Size: 5 1/2" long 1" lens

▲ FL-25
\$9⁹⁹

FIRST CLASS LED RECHARGEABLE FLASHLIGHT



- Machined Aircraft Aluminum body
- Intense 3 Watts LED
- Output: 100 lumens
- Continuous run time of 3 hours
- 3.6 voltage Rechargeable Battery with wall charger system
- 3 Multi-function modes (high beam, low beam & rapid flasher) and a zoom lens feature



▶ FL-30 **\$29⁹⁹**

3W LED RECHARGEABLE FLASHLIGHT

- Output: 150 Lumens
- Size: 1 3/4" D x 10"L
- Material: Aluminum
- Batteries: rechargeable

\$29⁹⁹



▲ FL-40

(Unscrew ring to access recharging plug) →



3W LED FLASHLIGHT - 3 C CELL

- Output: 100 lumens • Material: Aluminum
- Batteries: 3 C cells not included • Size: 1 1/2"D x 9 3/4"L



\$8⁹⁹ ▲
FL-42

Fits our baton holders N-13 & L-13



3W LED FLASHLIGHT - 3 D CELL

- Output: 100 Lumens • Material: Aluminum •
- Batteries: 3 D cells not included • Size: 2"D x 12 1/2"L



\$9⁹⁹ ▲
FL-41



1 W LED MINI FLASHLIGHT

- LED 1 Watt • Material: Aluminum
- SIZE: 1"D x 4½" • Belt/Shirt clip • Batteries: 1X AA battery



3W LED FLASHLIGHT RECHARGEABLE

- Output: 100 lumens • Size: 1¼" D x 5 ¾" L
- Material: Aluminum • Belt/Shirt clip
- Includes: Battery and charger (up to 240 volts)



3W LED RECHARGEABLE FLASHLIGHT

- Output: 100 lumens • Size: 1¼"D x 6"L
- Material: Aluminum • Batteries: Rechargeable battery



EMERGENCY HANGING FLASHLIGHT

- LED Brightness: 13,000MCD
- SIZE: 13¾" L x 3¼" W x 2¼" D
- Material: Plastic with rubber grip
- Batteries: 600MAH NI-MH battery



32 LED HANGING FLASH LIGHT

- LED Brightness: 13,000MCD
- Size: 9¾" L x 2½" W x 2"D
- Material: ABS with rubber
- Batteries: 3xAA batteries



All prices subject to change. Any pictorial or typographical errors subject to correction when an order is placed.
Proof of occupation is required for purchase of any law enforcement items.

UAW WILL MATCH COMPETITORS PUBLISHED PRICES

76 FLASHLIGHTS

5.11 UC3.400 FLASHLIGHT



A lifetime of light - 5.11's Light For Life Flashlight features engineered polymer bodies that are crack and bend resistant. Internal components that are rated for 50,000 cycles (that's about 135 years if you discharge and charge the light daily). 5.11 flashlights are covered by a Lifetime Warranty. Flashlights are light enough to float and their construction is water resistant.



NO BATTERY TO REPLACE EVER



Charging Station ▶



RECHARGES IN ONLY 90 SECONDS

Style	Name	Program	1 Click	2 Clicks	Hold	Runtime	Charge	Length	Weight
53123	UC3.400 P2	Ramp	270 Lumens	Strobe	Ramp-up	20 Min @ 270 60 Min @ 90 Plus 60 Min emergency light	90 seconds	11½"	16 oz
53133	UC3.300 P2	Ramp	200 Lumens	Strobe	Ramp-up	13 Min @ 200 45 Min @ 70 Plus 15 Min emergency light	90 seconds	8¾"	10 oz

\$169⁹⁹

TGF-53123

\$159⁹⁹

TGF-53133

MINI LED FLASHLIGHT SETS WITH CASES

- High light output bulbs • Depress tail cap for brief illumination • High-grade aluminum body with knurled grip • Uses 2 lithium CR123A batteries (not included)



Size: 5" long 1" lens

REAR TURN ON/OFF



1 XENON FLASHLIGHT

FL-07 **\$9⁹⁹**

6 LED FLASHLIGHT

FL-17 **\$9⁹⁹**

**3W 1 LED FLASHLIGHT
EXTREMELY BRIGHT**

FL-16 **\$9⁹⁹**

100 lumens

Tel: (877) 643-1100 ---- Toll Free
Fax: (877) 700-4477 ---- Toll Free

(818) 341-1500 (US & NON US calls)
(818) 341-0015 (US & NON US calls)

Phone Ordering Only
M-F 7:30am - 5:00pm PST
Sat 9am - 2pm PST

PHOENIX STUN GUN FLASHLIGHT

- Rechargeable High Voltage Stun Gun with Flashlight
- 2,500,000 Volts • Durable ABS Plastic housing • Charged metal strips prevents an attacker from grabbing the stun gun • Size - 6.5" L X 1.8" W X 1" D • Built-in 7.2V rechargeable battery and LED light • Includes AC charging cable, nylon holder and wrist grip • Charge time 10 hours, use time 15 minutes

\$24⁹⁹

SG-03 ▶



RECHARGEABLE FLASHLIGHT AND STUN GUN

- 800,000 Volts
- Durable ABS plastic housing
- Slide on/off safety switch with separate firing button
- Built-in 7.2v rechargeable battery, LED light and slide in/out AC plug - charge time 10 hours use time 15 minutes
- Includes nylon holder
- Size: 5½"L x 2"W x 1"D

\$19⁹⁹

SG-01 ▶

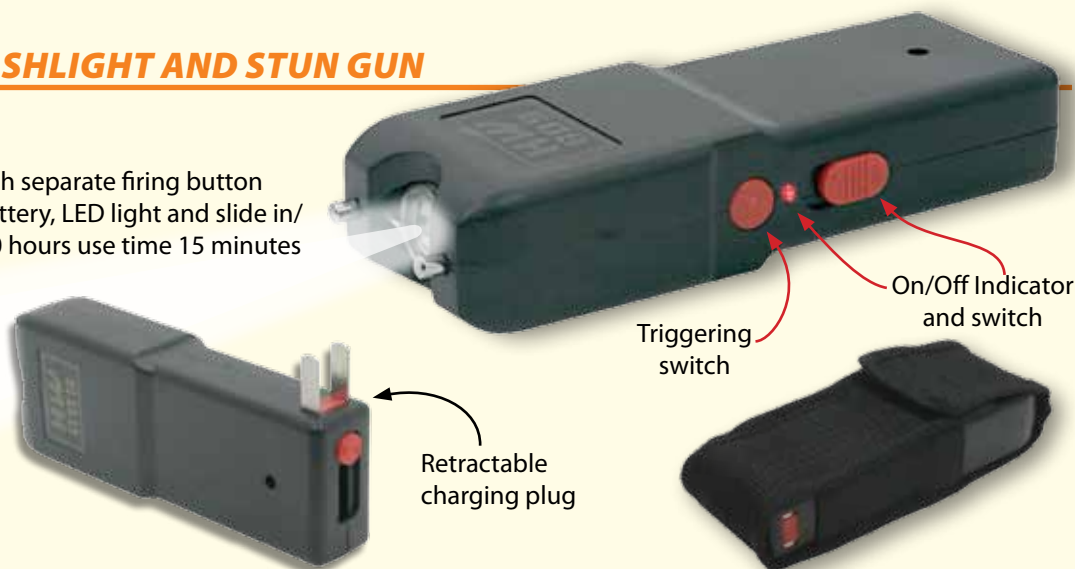

COMPACT RECHARGEABLE STUN GUN & FLASHLIGHT

- 800,000 volts
- Durable ABS plastic housing
- Slide on/off safety switch with separate firing button
- Smooth contour grip
- Built-in rechargeable battery, LED light and slide in/out AC plug - charge time 10 hours use time 15 minutes
- Includes nylon holder
- Size: 4½"L x 2½"W x 1½"D

Retractable charging plug

On/Off switch

Triggering switch

\$19⁹⁹

SG-02



All prices subject to change. Any pictorial or typographical errors subject to correction when an order is placed. Proof of occupation is required for purchase of any law enforcement items.

UAW WILL MATCH COMPETITORS PUBLISHED PRICES

SUPER ALKALINE BATTERIES



AAA size battery

BAT-08 ▲

99¢ Set of 4



AA size battery

BAT-09 ▲

99¢ Set of 4



C size battery

BAT-10 ▲

99¢ Each



D size battery

BAT-11 ▲

99¢ Each



9 Volt size battery

BAT-12 ▲

99¢ Each

REPLACEMENT BATTERIES



AA size battery

BAT-02
99¢



C size battery

BAT-32
\$1⁹⁹



D size battery

BAT-01
\$1⁹⁹



9 Volt size battery

BAT-03
\$3⁹⁹



Lithium

BAT-04
\$1⁹⁹

Use with the FL-30 flashlight
pictured on pages 74



\$9⁹⁹ ▲ BAT-13

Use with the FL-04 flashlights on pages 59 and
Rechargeable Maglite FL-32 on page 70



\$9⁹⁹ ▲ BAT-05

Replacements for
FL-40 flashlights

▲ BAT-40
\$9⁹⁹

Use with the FL-09
flashlight



\$9⁹⁹ ▲ BAT-14

Fits most Streamlight
model flashlights

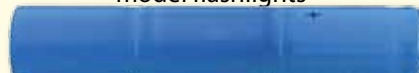

\$9⁹⁹ ▲ BAT-07

Replacements for
Stinger flashlights

▲ FL-75175
\$19⁹⁹



Item	Fits Radio Model#	Style	Description	Price
BAT-20	HT1000/GP900/MTX838/MTX9000/MTX8000	Motorola	NiMH 1800mAh	\$19.99
BAT-21	HT600/HT800/MT1000/MTX800/MTX900	Motorola	NiMH 1800mAh	\$19.99
BAT-22	HT750/HT1250/GP340/GP320/GP328/PRO5150	Motorola	NiMH 1500mAh	\$19.99
BAT-23	P110	Motorola	NiMH 1800mAh	\$19.99
BAT-24	P1225	Motorola	NiMH 1800mAh	\$29.99
BAT-25	GP88/GP300	Motorola	NiMH 1500mAh	\$19.99
BAT-26	XTS3000/XTS3500	Motorola	NiMH 1700mAh	\$24.99
BAT-27	XTN446	Motorola	NiMH 1500mAh	\$19.99
BAT-28	TK-260/360/270/370/2107/3107/UA100/UA200/UA01	UAW & Kenwood	NiMH 1800mAh	\$19.99
BAT-29	TK-250/TK-350	Kenwood	NiMH 1600mAh	\$19.99
BAT-30	TK-280/290/380/390/480	Kenwood	NiMH 1800mAh	\$19.99

Tel: (877) 643-1100 ---- Toll Free
Fax: (877) 700-4477 ---- Toll Free

(818) 341-1500 (US & NON US calls)
(818) 341-0015 (US & NON US calls)

Phone Ordering Only
M-F 7:30am - 5:00pm PST
Sat 9am - 2pm PST

SECURITY LOCK BOX

- Metal enclosure with steel double folded at front and back welded to the frame
- Externally and internally polyester epoxy resin Grey textured paint
- Welded studs on back for direct fixing of mounting plate
- Perforated door reinforcement
- Concealed and easily removable hinges allowing over 120° door opening.
- Polyurethane gasket and front rain gutter ensures high degree of protection



\$24⁹⁹

LKBOX-03

Size: 11³/₄W x 15³/₄H x 5⁷/₈ D

\$19⁹⁹

LKBOX-02

Size: 9³/₄ W x 11³/₄H x 5⁷/₈ D

WORK GLOVES

- Strong Shoulder Leather
- Rubberized Safety Cuff
- Size : 2 1/2" Starch Cuff



\$1⁹⁹ per pair **GL-04**



- High visibility backing
- Rubberized Safety Cuff
- Size : 2 1/2" Starch Cuff

\$5⁹⁹ per pair

GL-06

CABLE PROTECTORS



\$29⁹⁹

BAR-06



\$29⁹⁹

BAR-07

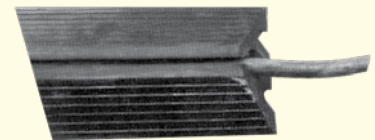

TRAFFIC CONE BAR

Place over traffic cones to cordon off an area for safety or any



Length: 78³/₄"
Loop: 3" opening

\$6⁹⁹ **BAR-05**



Size: 39¹/₄" x 5" x ³/₄"

All prices subject to change. Any pictorial or typographical errors subject to correction when an order is placed.
Proof of occupation is required for purchase of any law enforcement items.

UAW WILL MATCH COMPETITORS PUBLISHED PRICES

FOLDING KNIVES



- Made of #420 steel
- Blade Surface: Camouflage
- Includes nylon case
- Open length: 5½"
- Closed length: 4¾"

KN-01
\$9⁹⁹



- Made of #420 steel
- Blade Surface: Black satin
- Includes nylon case
- Open length: 6¾"
- Closed length: 4¾"

KN-02
\$9⁹⁹



- Made of #420 steel
- Blade Surface: Black satin
- Includes nylon case
- Open length: 8"
- Closed length: 4½"

KN-03
\$9⁹⁹

You must check your own state for laws and regulations on the use of knives.



- Made of #420 steel
- Blade Surface: Polished
- Includes nylon case
- Open length: 6¾"
- Closed length: 4"

KN-04
\$7⁹⁹



- Made of #420 steel
- Blade Surface: Black satin
- Includes nylon case
- Open length: 7¾"
- Closed length: 4½"

KN-05
\$9⁹⁹



KN-06
\$7⁹⁹

- Made of #420 steel
- Blade Surface: Polished
- Includes nylon case
- Open length: 7¼"
- Closed length: 4¼"



White Shell
KN-07

\$8⁹⁹

Wood grain
KN-09

\$8⁹⁹

- Made of #420 steel
- Blade Surface: Black satin
- Includes nylon case
- Open length: 7¾"
- Closed length: 4½"

KN-08
\$9⁹⁹

- Made of #420 steel
- Blade Surface: Flat Black Textured
- Includes nylon case

- Open length: 7¾"
- Closed length: 4½"
- Mini Flashlight

GARRETT SUPERWAND

The new Garrett SuperWand features an ergonomic grip to fit comfortably in every hand.

Detecting all metallic objects, the Garrett SuperWand is ideal for use in government facilities, security operations, hospitals, banks, and community events. Users can choose between an audible and silent vibrate/LED lights alarm signal. The easy one-touch button & three-color display operation uses red, green & amber LED lights. Because it automatically retunes, the Garrett Super Wand requires absolutely no adjusting. The rugged injection molded construction features a structurally separate coil for increased impact absorption, yet the Garret SuperWand is a light 16 ounces. Powered by a single 9V battery.



\$189⁹⁹ MD-20 ▲

Please call our toll-free number for special discounts when you purchase 50 units or more.

SCANNER - HANDHELD METAL DETECTOR

- Simple & convenient operation • Audio, LED and vibration alerts • Lightweight ABS structure • Large detection area
- Automatic battery check • Automatic reset switch for sensitivity change • Requires 9V battery not included • Size: 16¼" x 2½"

\$49⁹⁹ MD-01 ▶



HANDHELD METAL DETECTORS

- Small, lightweight and easy to use • Detects both ferrous and non-ferrous metal • Audible and visible alarms
- Requires 9V battery (not included) • Alerts when battery is low • Size: only 13¾" inches long!

\$19⁹⁹ MD-10 ▶

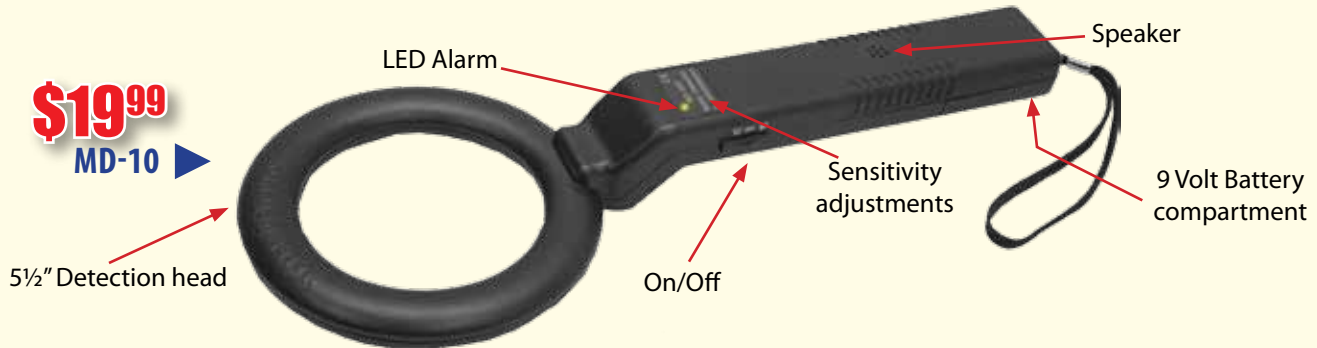

SCANNER - HANDHELD METAL DETECTOR

- High sensitivity • Simple and convenient operation • It can easily detect pin-sized metal articles (3.5cm to the probe).
- It with a large detecting area can complete the detection by moving from top to bottom, greatly improving the working efficiency.
- It has an independent battery low voltage system and the yellow light will be on
- It has double indication modes, namely sound & light and vibration to accurately and rapidly judge the metal position • With shielded damp-proof sensitivity adjusting hole, it seldom fails and is economic and durable • Can work for 40 hours continuously

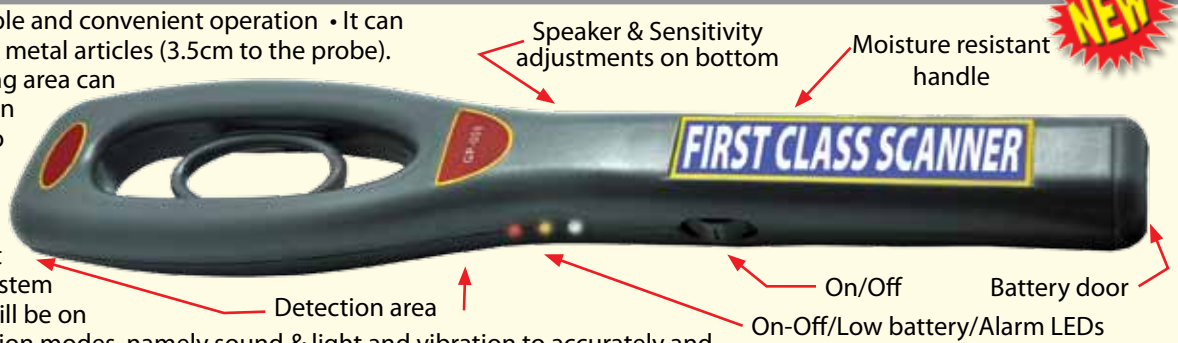

\$49⁹⁹ ▲ MD-02

All prices subject to change. Any pictorial or typographical errors subject to correction when an order is placed. Proof of occupation is required for purchase of any law enforcement items.

UAW WILL MATCH COMPETITORS PUBLISHED PRICES

THE GUARDSCAN SYSTEM

- ◆ **WHY YOUR AGENCY SHOULD HAVE OUR GUARDSCAN MANAGEMENT SYSTEM** ◆
 - ARE YOU LOSING CUSTOMERS?
 - DO YOU WANT TO INCREASE YOUR CUSTOMER BASE?
- ◆ **WE HAVE A SOLUTION FOR YOU!** ◆
 - PROVE THAT YOU OFFER THE BEST SERVICE WITH THE GUARDSCAN SET.

ATTRACT NEW CUSTOMERS & BRING EXISTING CUSTOMERS TO A NEW LEVEL OF PROFESSIONALISM WITH THE GUARDSCAN MANAGEMENT SYSTEM.

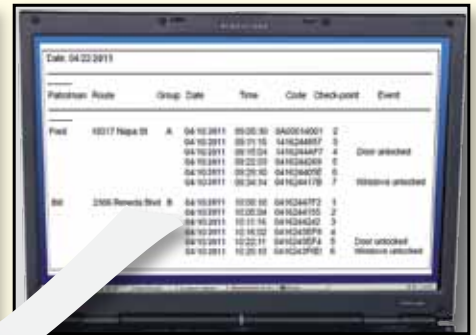

This system functions easily as a hand-held data terminal. You simply scan each RFID (radio frequency identification disc) tag you place at check points you choose on a patrol route. Guard accountability increases as each guard must scan the tags to validate each check point. By scanning the tag, the date, time, location and any other incidentals will be logged into the data terminal. Download the information from the remote scanner to your computer and print simple and comprehensive professional reports to be reviewed with current and potential clients.

Date: 04/22/2011

Patrol Tour Report

Patrolman	Route	Group	Date	Time	Code	Check-point	Event
Fred	18317 Napa St	A	04/10/2011	09:05:10	0A00014001	2	
			04/10/2011	09:11:15	1416244857	3	
			04/10/2011	09:15:04	1416244AF7	4	Door unlocked
			04/10/2011	09:22:03	0416244269	5	
			04/10/2011	09:29:10	041624405E	6	
Bill	2306 Reseda Blvd	B	04/10/2011	09:34:14	041624417B	7	Windows unlocked
			04/10/2011	10:00:10	04162447F2	1	
			04/10/2011	10:05:04	0416244155	2	
			04/10/2011	10:11:16	0416244242	3	
			04/10/2011	10:16:02	0416243EF8	4	
04/10/2011	10:22:11	0416243EF4	5	Door unlocked			
04/10/2011	10:29:10	0416243F6D	6	Windows unlocked			

FREE Patrol Manager software valued at \$99.95 when you buy your 1st set of The Guardscan Management System

THE GS1100 HANDHELD SCANNER SYSTEM

Set Includes:

- Remote Scanner • Leather holder • Belt clip for leather holder • 1 AA size battery • Patrol manager software (for 1st time buyer only) • USB data download cable • 4 RFID tags (*buy more below*)

New Features:

- Vibration feedback upon scanning of each RFID tag
- Single alkaline battery is easy to replace and lasts up to 50,000 scans
- Lightweight, only 5.4oz with battery

Upon receipt of your Guardscan Management System Set, scan each tag into your computer using your free software.



◀ **GS-1100**

MSRP \$499⁹⁵

PRICE REDUCTION NOW ONLY \$199⁹⁹



EVENT WALLET

Tags sold separately for each system

KP-1000 \$39⁹⁹

RFI-01 \$1⁹⁹

Strategically place tags at desired check-points.

UPGRADE TODAY FROM THE GS1000

GS1000 users can upgrade to the new GS1100 and keep their existing software.

- A M-09 Scanner case.....\$19.99
- B RFI-01 RFID tags..... \$1.99
- C RFI-03 Key Ring RFID tags \$2.99

Tel: (877) 643-1100 ---- Toll Free
Fax: (877) 700-4477 ---- Toll Free

(818) 341-1500 (US & NON US calls)
(818) 341-0015 (US & NON US calls)

Phone Ordering Only
 M-F 7:30am - 5:00pm PST
 Sat 9am - 2pm PST

GS3000 HANDHELD PATROL TOUR SYSTEM

ARE YOUR EMPLOYEES SLEEPING ON THE JOB? COMING LATE OR LEAVING EARLY? DOES ANYONE KNOW IF THEY ARE CHECKING EVERY IMPORTANT LOCATION? LET GUARDSCAN SOLVE ALL THESE AND MORE!

The handheld Patrol Tour System features the latest in memory chip technology. When tag is scanned it records the tag code, time and the date. The data can be downloaded to your computer. It is the ideal solution for companies wishing to track employees whose work duties require moving from place to place, such as security guard

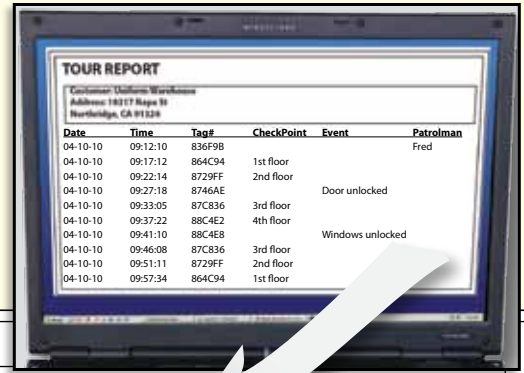

TOUR REPORT

Customer: Uniform Warehouse
Address: 18317 Napa St
Northridge, CA 91324

Date	Time	Tag#	CheckPoint	Event	Patrolman
04-10-10	09:12:10	836F9B			Fred
04-10-10	09:17:12	864C94	1st floor		
04-10-10	09:22:14	8729FF	2nd floor		
04-10-10	09:27:18	8746AE		Door unlocked	
04-10-10	09:33:05	87C836	3rd floor		
04-10-10	09:37:22	88C4E2	4th floor		
04-10-10	09:41:10	88C4E8		Windows unlocked	
04-10-10	09:46:08	87C836	3rd floor		
04-10-10	09:51:11	8729FF	2nd floor		
04-10-10	09:57:34	864C94	1st floor		

patrolling, policeman patrolling, remote equipment inspection, etc. The remote scanner records the date, time and tag ID when bought in contact with a button tag. Use the included Patrol Management Lite software to download and generate reports, which can be printed or exported to MS Word/Excel, PDF, JPG, and much more. The software is easy to learn and use!

- Durable stainless steel body with rubber grip is shock and water resistant
- Scanner records Date, Time, and ID information of each check point visited

- Built-in battery lasts up to 400,000 scans
- Weight: 11.3 oz
- Size: 5¾" H x 1½" L x 1½" W
- Easy to use software
- Replaceable CR123A 3V Lithium battery



MSRP: \$499.99

\$129⁹⁹

GS-3000 SCANNER ONLY

BUY 100+ SCANNERS AND SAVE 10%



MSRP: \$6.99

Tag & Holder

GS-3001 BASE UNIT

\$79⁹⁹

MSRP: \$149.99

GS3006 EVENT WALLET

- Compatible with the GS3000 Patrol system
- Durable wallet with convenient magnetic snap and set of 10 event tags
- Program up to 10 events



MSRP: \$69.99

\$49⁹⁹

GS-3006

GS-3007 \$3⁹⁹

MSRP: \$4.99

Tag Holder



GS-3003

99¢

MSRP: \$2.99

Tags sold separately for each system

GS-3004 \$3⁷⁹

Button Tags



GS-3002

\$2⁹⁹

MSRP: \$4.99

PATROL TOUR SYSTEM SET

\$199⁹⁹

GS-3000A

Includes: MSRP: \$999.99

- 1 - Remote scanner
- 1 - Base unit
- 10 - Button tags & holders
- 1 - Software CD
- 1 - USB transfer cable

All prices subject to change. Any pictorial or typographical errors subject to correction when an order is placed.

Proof of occupation is required for purchase of any law enforcement items.

UAW WILL MATCH COMPETITORS PUBLISHED PRICES

GARRETT PD 6500I WALKTHROUGH

The PD 6500i is the world's highest performing walk-through metal detector and leads the industry with superior pinpoint technology and unmatched discrimination and sensitivity features. Designed for maximum patron throughput without compromising safety, the PDi is the walk-through of choice for security professionals worldwide.

- Easy Assembly
- 33 Distinct Pinpoint Detection Zones
- Entry Facing Lights
- Overhead Control Unit
- Multi-dimensional Coil Design
- Audible and Visual Alarms
- Access Control Panel



The PD 6500i's Access Control Panel is

designed for use by authorized personnel with specific, multi-level security codes. It allows authorized users to change settings such as detection Program and Sensitivity. Security of the detector's settings is maintained with a non-resettable sequence code, which indicates every attempt at access to the settings. A tamper alarm sounds within 10 seconds after the Access Touch pad is pressed, unless a proper access code is entered.



The PD 6500i maintains all settings even when disconnected from power and does not require recalibration each time the unit is turned OFF and back ON. No battery is required for memory retention.

Suggested retail price: \$5,945.00

\$3,895⁹⁹
PD-6500I ▲

GARRETT MT 5500 WALKTHROUGH

The MT 5500 is one of the world's most popular walk-through metal detectors because it provides maximum throughput with unparalleled multi-dimensional scanning. The MT 5500 meets the demanding needs of security professionals worldwide who trust its ability to maintain a high flow rate with minimal alarms.

- Easy Assembly
- Multi-Dimensional Scanning
- Microprocessor Controlled
- Audible and Visual Alarms
- Detection Field
- Access Control Panel

The Access Control Panel is designed for use by authorized personnel with specific security codes. It allows authorized users to change settings such as



Program and Sensitivity. Security of the detector's settings is maintained with a non-resettable sequence code, which indicates every attempt at access to the settings. A tamper alarm sounds within 10 seconds after the Access touch pad is pressed unless a proper access code is entered.

The MT 5500 includes 20 standard programs, which are maintained in an electrically erasable non-volatile memory, for the ultimate in security application versatility. The unit maintains all settings even when disconnected from power and does not require recalibration when unit is turned OFF and back ON. No battery is required for memory retention.



Suggested retail price: \$4,995.80

\$3,495⁹⁹
MT-5500 ▲

DETE-KING IIID WALKTHROUGH METAL DETECTOR

Designed for security professionals that are looking for a full-featured metal detector at an unbeatable value. The WE002 exceeds or meets specifications of more expensive brand names. By using six overlapping detection zones, the multi-channel metal detector can detect with pinpoint accuracy the location of metal objects. Advanced microprocessor technology allows you to selectively adjust the sensitivity in each detection zone.

- Easy Assembly
- 6 Distinct Pinpoint Detection Zones
- Audible and Visual Alarms
- Overhead Control Unit
- 100 Sensitivity Levels

Compound circuit design allows visible count of people who have passed through. With the help of DSP technology, false alarms are minimized. Password protected access panel maintains security of all the detector's settings.



MSRP
\$3,000.95
\$1,999⁹⁹
MD-15 ▶

WALKTHROUGH UNIT RENTALS
\$499.99/week
Southern California area only.
Please call for availability.

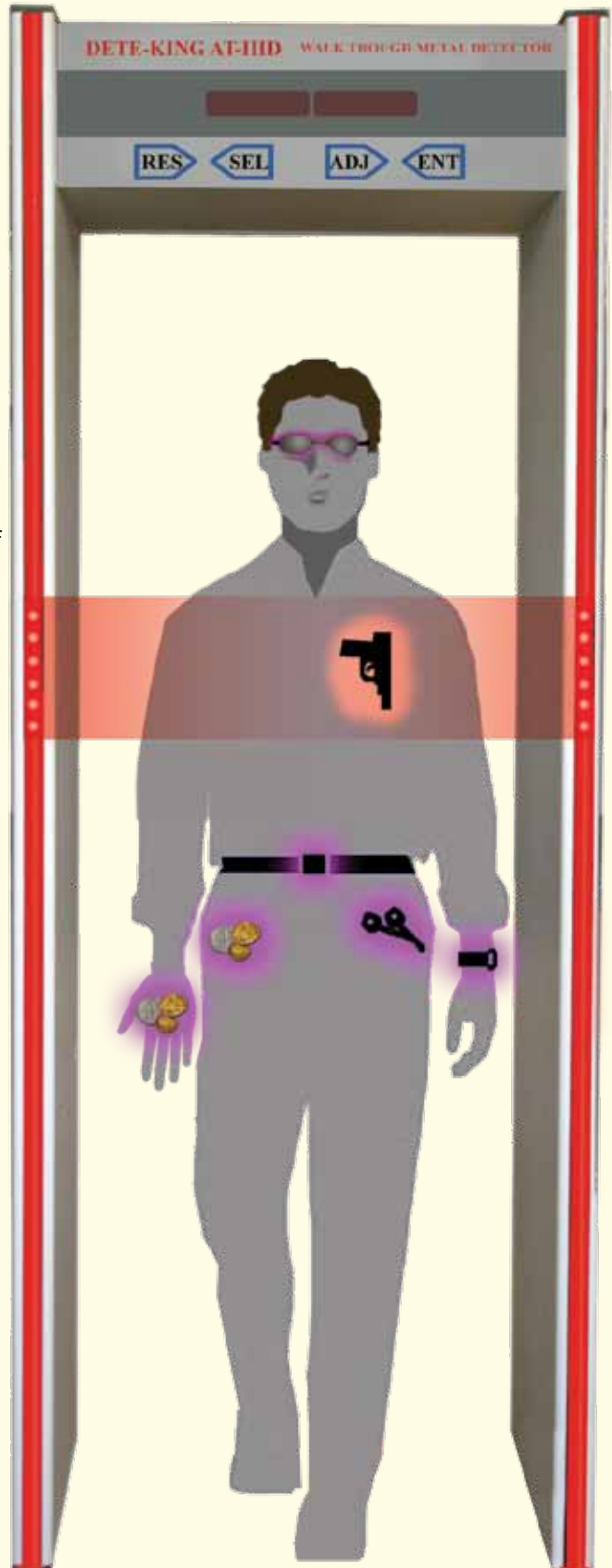

Door size: 77¾"H x 27¼"W x 19½"D
Frame size: 87½"H x 31½"W x 19½"D

*All prices subject to change. Any pictorial or typographical errors subject to correction when an order is placed.
Proof of occupation is required for purchase of any law enforcement items.*

UAW WILL MATCH COMPETITORS PUBLISHED PRICES

DESIGN YOUR OWN BADGE

IT'S SO EASY ANYONE CAN DO IT!

We at Uniform Warehouse are always looking for innovative ways to improve your experience with us. We are proud to introduce our high quality traditional heavy weight custom badges. They come in gold, silver or two tone and won't fade or tarnish. Never before has designing your own badge been so easy and intuitive. You create your own badge in 2 quick steps. Here's what you can do!

Choose a badge design...

Our professional pre-made designs have no minimum order requirement and no setup fee. Buy in bulk and save. Add \$19.99 USD for shipping of any quantity.

QUANTITY	1-2	3-5	6-12	13-24	25-49	50-99	100-199	200-299	300-499	500+
PRICE	39.99	29.99	27.99	23.99	20.99	17.99	15.99	13.99	12.99	10.99

1. DESIGN IT!

- Click on the **Build Your Badge** link on our web site www.uniforms4all.com
- Choose from our professional pre-made designs or your own for an extra fee
- Select a center seal from our list of over 80 or even use your logo for an extra fee
- Select the font type (Block or Times New Roman)
- Choose the text color (Black, Blue or Red)
- Indicate the desired text for each banner in your selected design



Badge design
PB-03

Center seal design
Seal-Flag

Font type
 Block Times Other

Text Color
Blue

Banner 1
TEXT HERE

Banner 2
TEXT HERE TEXT HERE

Banner 3
101



Choose from our list of designs

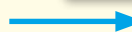

Simply enter your information!

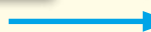

Your finished design!



2. ORDER IT!

We know you have many choices, but no one can beat our quality or our prices. Order your badge with the assurance that our badges come with a 100% Satisfaction Guarantee. Be assured that we always strive to meet your expectations. *(An art fee will apply for designs we do not offer)*

Tel: (877) 643-1100 ---- Toll Free
 Fax: (877) 700-4477 ---- Toll Free

(818) 341-1500 (US & NON US calls)
 (818) 341-0015 (US & NON US calls)

Phone Ordering Only
 M-F 7:30am - 5:00pm PST
 Sat 9am - 2pm PST

PB-01
2 1/2" x 3 3/8"



PB-02
2 1/2" x 3 3/8"



PB-03
2 1/2" x 3 3/8"



PB-04
2 1/2" x 3 3/8"



PB-13
2 1/4" x 3 1/4"



PB-14
2 1/4" x 3 1/4"



PB-05
2 1/4" x 3"



PB-06
2" x 3"



PB-15
2 1/4" x 3 1/4"



PB-16
2 1/4" x 3 1/4"



PB-17
2 1/4" x 3 1/4"



PB-18



QUANTITY	1-2	3-5	6-12	13-24	25-49	50-99	100-199	200-299	300-499	500+
PRICE	39.99	29.99	27.99	23.99	20.99	17.99	15.99	13.99	12.99	10.99

All prices subject to change. Any pictorial or typographical errors subject to correction when an order is placed.
Proof of occupation is required for purchase of any law enforcement items.

UAW WILL MATCH COMPETITORS PUBLISHED PRICES

DESIGN YOUR OWN CUSTOM BADGE

PB-19



PB-20



2 1/4" x 3 1/4"

PB-21



PB-22



PB-09



2 1/4" x 3 3/8"

PB-10



PB-24



2 1/2" x 3 3/8"

PB-23



PB-07



3" x 3"

PB-08



3" x 3"

PB-33



2 3/4" x 3"

PB-34



2 1/2" x 3"

QUANTITY	1-2	3-5	6-12	13-24	25-49	50-99	100-199	200-299	300-499	500+
PRICE	39.99	29.99	27.99	23.99	20.99	17.99	15.99	13.99	12.99	10.99

Tel: (877) 643-1100 ---- Toll Free
 Fax: (877) 700-4477 ---- Toll Free

(818) 341-1500 (US & NON US calls)
 (818) 341-0015 (US & NON US calls)

Phone Ordering Only
 M-F 7:30am - 5:00pm PST
 Sat 9am - 2pm PST

PB-11
3" x 3"



PB-12
3" x 3"



PB-27
3" x 3"



PB-25
3" x 3"



PB-26
3" x 3"



PB-28
3" x 3"



PB-29
3" x 3"



PB-30
3" x 3"



PB-31
3" x 3"



PB-32
3" x 3"

QUANTITY	1-2	3-5	6-12	13-24	25-49	50-99	100-199	200-299	300-499	500+
PRICE	39.99	29.99	27.99	23.99	20.99	17.99	15.99	13.99	12.99	10.99

All prices subject to change. Any pictorial or typographical errors subject to correction when an order is placed.
Proof of occupation is required for purchase of any law enforcement items.

UAW WILL MATCH COMPETITORS PUBLISHED PRICES

CHOOSE AN ALTERNATE SEAL

We offer these attractive center seals and many more online including country flag seals! All at no extra charge! Want a seal not shown? No problem! A \$99 extra charge applies to create your own custom seal.



Gold Scale (Black)



Gold Scale (Blue)



Gold Scale



Flag



U.S. Eagle (Gold)



U.S. Eagle (Silver)



Globe



Gold Star (Black)



Gold Star (Blue)



Gold Star (Gold)



Pride Eagle (Gold)



Pride Eagle (Silver)



Canada



Mexico



US Coat of Arms (Black)



US Coat of Arms (Blue)



US Code of Arms (Gold)



Your State Seal



EMT (Blue)



EMT (Silver)



EMT



Cross (First Aid)



Cross (Rescue)



Fire Truck



Christian Cross Gold/Silver



Star of David



Crescent Star



Bible Cross



Steeple



Prayer Hands



Fireman (Volunteer)



F.D. Red
(Also in Blue)



Fireman (Blue)



Fireman (Red)



FD Ranks
(All ranks Available
and in Blue)

CREATE YOUR OWN CUSTOM CENTER SEAL

Our staff artists can use your logo, custom design or even a sketch to create your very own custom seal.



A one time \$99⁰⁰ mold fee applies



CHOOSE YOUR TEXT AND FINISH

Put your company name, officer name or rank and badge number on any design.

A full color proof can be emailed to you for your approval on request.

Tel: (877) 643-1100 ---- Toll Free
Fax: (877) 700-4477 ---- Toll Free

(818) 341-1500 (US & NON US calls)
(818) 341-0015 (US & NON US calls)

Phone Ordering Only
M-F 7:30am - 5:00pm PST
Sat 9am - 2pm PST

OUR POPULAR STOCK BADGE DESIGNS

• High quality gold or silver rhodium electroplating • Hard enameled seals • Deluxe backings • Lacquered finish • Dark blue text

New Light Weight Badges Are 40% Lighter Than The Standard Delux Weight



Private Investigator
(Gold and silver)

3 3/8" x 2 1/4"



\$13⁹⁹ BA-01

Officer Private Security
(Gold and silver)

3 3/8" x 2 1/4"



\$13⁹⁹ BA-02

\$11⁹⁹ BA-02L
Light Weight

Security Private Officer
(Gold and silver)

3 3/8" x 2 1/4"



\$13⁹⁹ BA-03

Security Private Officer
(Gold)

3 3/8" x 2 1/4"



\$13⁹⁹ BA-04

Security Enforcement
Officer (Silver)

3" x 2"



\$9⁹⁹ BA-05

\$7⁹⁹ BA-05 L
Light Weight

Security Enforcement
Officer (Gold)

3" x 2"



\$9⁹⁹ BA-06

\$7⁹⁹ BA-06L
Light Weight

Security Officer
(Silver)

3 1/8" x 2 1/4"



\$9⁹⁹ BA-07

\$7⁹⁹ BA-07L
Light Weight

Security Officer
(Gold)

3 1/8" x 2 1/4"



\$9⁹⁹ BA-08

\$7⁹⁹ BA-08L
Light Weight

Firefighter Volunteer
Fire Dept. (Silver)

3 1/8" x 2 1/8"



\$14⁹⁹ BA-09

Firefighter Volunteer
Fire Dept. (Gold)

3 1/8" x 2 1/8"



\$14⁹⁹ BA-10

Security Private Officer
(Gold and silver)

3 3/8" x 2 1/4"



\$16⁹⁹ BA-11

Officer Private Security
(Gold and Silver)

3 3/8" x 2 1/2"



\$16⁹⁹ BA-12

All prices subject to change. Any pictorial or typographical errors subject to correction when an order is placed.

Proof of occupation is required for purchase of any law enforcement items.

UAW WILL MATCH COMPETITORS PUBLISHED PRICES

OUR POPULAR STOCK BADGE DESIGNS



High quality gold or silver rhodium electroplating • Hard enameled seals • Deluxe backings • Lacquered finish • Dark blue text

New Light Weight Badges Are 40% Lighter Than The Standard Deluxe Weight



Special Security Officer (Silver)
3" x 3"



\$9⁹⁹ BA-13

\$7⁹⁹ BA-13L
Light Weight

Special Security Officer (Gold)
3" x 3"



\$9⁹⁹ BA-14

\$7⁹⁹ BA-14L
Light Weight

Security Officer (Silver)
3" x 3"



\$9⁹⁹ BA-15

\$7⁹⁹ BA-15L
Light Weight

Security Officer (Gold)
3" x 3"



\$9⁹⁹ BA-16

\$7⁹⁹ BA-16L
Light Weight

Security Officer (Silver)
3³/₈" x 2¹/₄"



\$16⁹⁹ BA-17

Security Officer (Gold and silver)
3³/₈" x 2¹/₄"



\$16⁹⁹ BA-18

Security Private Officer (Silver)
3³/₈" x 2³/₈"



\$16⁹⁹ BA-19

Security Private Officer (Gold and silver)
3³/₈" x 2³/₈"



\$16⁹⁹ BA-20

Security Enforcement Officer (Gold and silver)
3³/₈" x 2³/₈"



\$16⁹⁹ BA-21

Security Enforcement Officer (Gold)
3³/₈" x 2³/₈"



\$16⁹⁹ BA-22

Emergency Medical Technician (Silver and blue)
3" x 2¹/₈"



\$14⁹⁹ BA-23

Emergency Medical Services (Gold and blue) (Silver and blue)
3" x 2¹/₈"



\$14⁹⁹ BA-24 BA-39

Tel: (877) 643-1100 ---- Toll Free
Fax: (877) 700-4477 ---- Toll Free

(818) 341-1500 (US & NON US calls)
(818) 341-0015 (US & NON US calls)

Phone Ordering Only
M-F 7:30am - 5:00pm PST
Sat 9am - 2pm PST

OUR POPULAR STOCK BADGE DESIGNS

• High quality gold or silver rhodium electroplating • Hard enameled seals • Deluxe backings • Lacquered finish • Dark blue text

Security Officer
(Silver)

3" x 3"



\$14⁹⁹

BA-25

Security Officer
(Gold)

3" x 3"



\$14⁹⁹

BA-26

Security Guard
(Silver)

3 3/8" x 2 3/4"



\$13⁹⁹

BA-27

Security Guard
(Gold)

3 3/8" x 2 3/4"



\$13⁹⁹

BA-28

Private Security Officer
(Silver)

3" x 3"



\$16⁹⁹

BA-29

Private Security Officer
(Gold)

3" x 3"



\$16⁹⁹

BA-30

Security Private Officer
(Silver)

3 3/8" x 2 3/4"



\$16⁹⁹

BA-31

Security Private Officer
(Gold and Silver)

3 3/8" x 2 3/4"



\$16⁹⁹

BA-32

Loss Prevention Officer
(Gold and Silver)

3 3/8" x 2 3/4"



\$16⁹⁹

BA-35

Supervisor Private Officer
(Gold and Silver)

3 3/8" x 2 1/2"



\$16⁹⁹

BA-36

Sergeant Private Officer
(Gold and Silver)

3 3/8" x 2 3/4"



\$16⁹⁹

BA-37

Officer Private Security
(Gold and Silver)

3 3/8" x 2 3/8"



\$16⁹⁹

BA-38

All prices subject to change. Any pictorial or typographical errors subject to correction when an order is placed.
Proof of occupation is required for purchase of any law enforcement items.

UAW WILL MATCH COMPETITORS PUBLISHED PRICES

OUR POPULAR STOCK BADGE DESIGNS

Motor Officer Traffic Control
(Gold and Silver)

3 1/2" x 2 1/2"



\$16⁹⁹ BA-40

Lieutenant Private Security
(Gold & Silver)

3 1/2" x 2 1/2"



\$16⁹⁹ BA-41

Captain Private Security
(Gold and Silver)

3 1/4" x 2 1/2"



\$16⁹⁹ BA-42

CHOOSE YOUR BADGE BACKING - SELECTIONS FOR FULL SIZE CUSTOM BADGES



PIN & SAFETY CATCH



WALLET/BELT CLIP



SCREW & CLUTCH



PERMANENT MOUNT
NO ATTACHMENT

CUSTOMIZED HIGH QUALITY TRADITIONAL BADGES



We at Uniform Warehouse are always looking for innovative ways to improve your experience with us. We are proud to provide our high quality traditional heavy weight custom badges. They come in gold or silver rhodium electro plating and won't fade or tarnish. Never before has designing your own badge been so easy and intuitive. You create your own badge in 2 quick steps. See our web site or pages 86 - 90 for full details.

Tel: (877) 643-1100 ---- Toll Free
Fax: (877) 700-4477 ---- Toll Free

(818) 341-1500 (US & NON US calls)
(818) 341-0015 (US & NON US calls)

Phone Ordering Only
M-F 7:30am - 5:00pm PST
Sat 9am - 2pm PST

MINIATURE BADGES & LAPEL PINS

Miniature Badge Pins By Popular Demand...

Our **NEW STOCK** miniature lapel pins are ¾" x 1". They have a standard lapel pin clutch back.

\$4⁹⁹

LPB-01
Pride Eagle (Gold)

LP-01

\$4⁹⁹

LPB-02
Liberty Bell (Gold)

LP-02

\$4⁹⁹

LPB-03
Flag (Blue)

LP-03



Mini Badge Pins 1" x ¾"
For custom versions of these lapel pins contact our art department.



Lapel Pins 1" x 1"

Custom Lapel Pins:

Size: 1" Mold fee: \$99⁰⁰ Production time: 4 weeks upon approval

QUANTITY	100-149	150-499	500-999	1000-2999	3000+
PRICE	\$3.95ea	\$2.85ea	\$1.95ea	\$1.49ea	\$1.09ea

Size: 1¼" Mold fee: \$99⁰⁰ Production time: 4 weeks upon approval

QUANTITY	100-149	150-499	500-999	1000-2999	3000+
PRICE	\$4.25ea	\$3.25ea	\$2.15ea	\$1.65ea	\$1.00ea

Size: 1¾" Mold fee: \$99⁰⁰ Production time: 4 weeks upon approval

QUANTITY	100-149	150-499	500-999	1000-2999	3000+
PRICE	\$4.69ea	\$3.69ea	\$2.13ea	\$1.56ea	\$1.19ea

POCKET BADGES

2¾"

3¾"

MINIATURE BADGE ON A LUCITE OR BRUSHED METAL POCKET HOLDER
(Badge is attached to holder)

MPB-01

MPB-02

Choose from our over 30 different badge styles in gold or silver.
See page 96 or our web site for all the mini badge choices.

Price includes the Mini-badge. Orders may be placed directly by phone or on our web site.

Pocket clip

QUANTITY	1-2	3-5	6-12	13-24	25-49	50-99	100-199	200-299	300-499	500 & Up
PRICE	39.99	29.99	27.99	24.99	22.99	18.99	16.99	15.99	14.99	12.99

All prices subject to change. Any pictorial or typographical errors subject to correction when an order is placed.
Proof of occupation is required for purchase of any law enforcement items.

UAW WILL MATCH COMPETITORS PUBLISHED PRICES

MINIATURE SIZE BADGES

By Popular Demand...

The same high quality as our full size badges. All have a standard pin backing.



Create your miniature badges on our web site the same easy way as our full size ones.

- 1) Choose your base
- 2) Choose your text
- 3) Choose your seal



Use our Buildyourbadge.com web site for fast accurate service.

QUANTITY	1-2	3-5	6-12	13-24	25-49	50-99	100-199	200-299	300-499	500+
PRICE	29.99	24.99	22.99	19.99	17.99	15.99	13.99	11.99	9.99	8.99

Tel: (877) 643-1100 ---- Toll Free
 Fax: (877) 700-4477 ---- Toll Free

(818) 341-1500 (US & NON US calls)
 (818) 341-0015 (US & NON US calls)

Phone Ordering Only
 M-F 7:30am - 5:00pm PST
 Sat 9am - 2pm PST

DESIGN YOUR OWN EMBLEM FOR AN UNBELIEVABLY LOW PRICE.

IT'S SO EASY ANYONE CAN DO IT!

At Uniform Warehouse, we are always looking for new and innovative ways to improve your experience with us. We are proud to introduce our custom emblems. Never before has designing your own emblem been so easy and intuitive. You can do it in a few quick steps!

1. DESIGN IT!

- Start with your own sketch and work with our talented professional design staff

or...

- Choose from our many shapes and designs on the next few pages and mix & match them to create your own perfect emblem

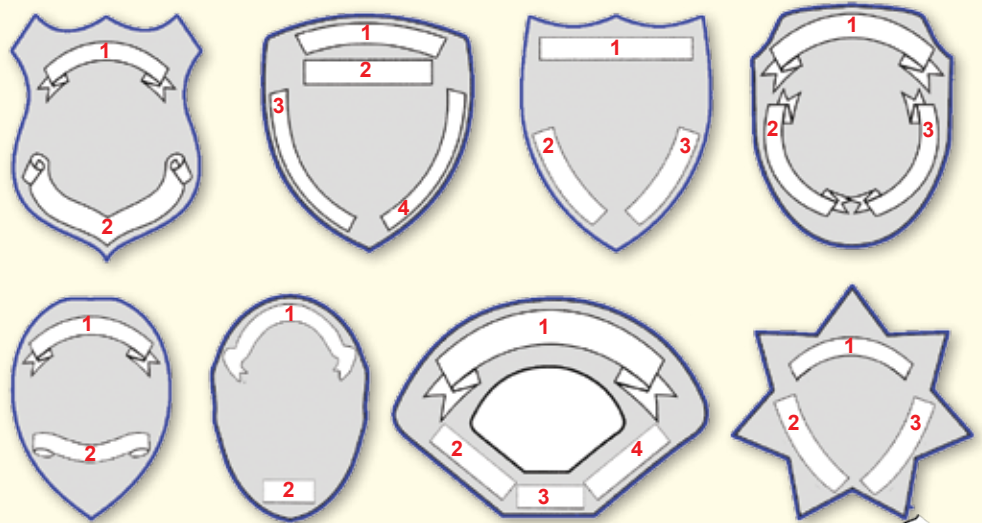
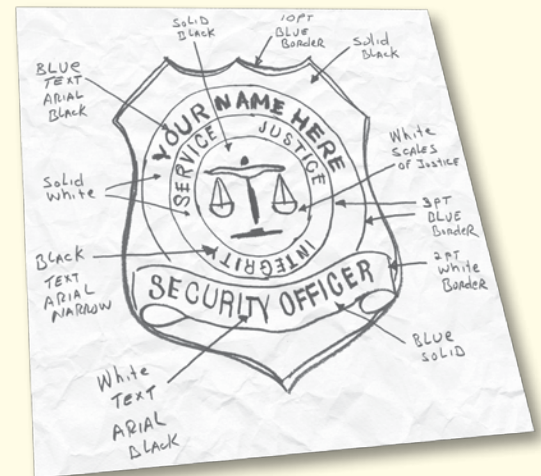

You then ...

LOOK ONLINE
for a complete selection

- Select a design and font type (Block or Times New Roman)
- Choose your text colors (Black, Blue, Red, Gold...)
- Indicate the desired text for each ribbon in your selected design

2. ORDER IT!

We know you have many options, but no one can beat our quality or prices. Order your emblem with the assurance that our emblems come with a 100% Satisfaction Guarantee. (An art fee may apply)

All prices subject to change. Any pictorial or typographical errors subject to correction when an order is placed.
Proof of occupation is required for purchase of any law enforcement items.

UAW WILL MATCH COMPETITORS PUBLISHED PRICES

CHOOSE FROM ONE OF OUR POPULAR DESIGN TEMPLATES:

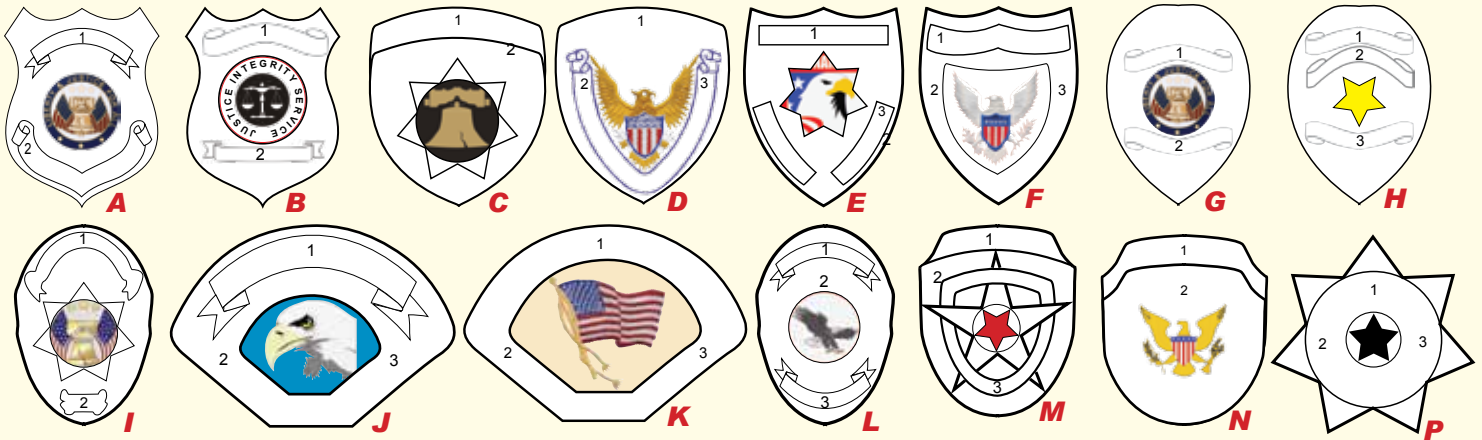

ARTWORK FEE: Use our talented staff artists to create your emblem. The artwork preparation fee is only \$75. It ensures you get the most professional looking product at the lowest possible price.

FOR YOUR CONVENIENCE: Call for details on how we can store and automatically reorder your custom patches. That way you never run out. Your patches are always in stock. Your garment orders can then be tailored and delivered quickly.

HEAT SEAL: A backing that allows you to simply use a hot iron to adhere your patches to most articles of clothing.

PRICE PER EMBLEM FOR 35-85% EMBROIDERY

Quantity Approx. Sizes	20	50	100	200	300	500	1000	2000	3000	Heat Seal (Add. each)
2½" x 2½"	4.49	2.09	1.79	1.29	1.09	.99	.69	.65	.55	.10
3" x 3"	4.79	2.89	1.99	1.39	1.25	1.09	.79	.70	.65	.15
3½" x 3½"	5.39	3.09	2.19	1.49	1.29	1.15	.89	.80	.70	.19
4" x 4"	5.99	3.29	2.29	1.59	1.35	1.22	.99	.90	.80	.25
4½" x 4½"	6.49	3.49	2.39	1.69	1.39	1.25	1.05	1.00	.90	.29
5" x 5"	6.99	3.59	2.49	1.85	1.75	1.29	1.15	1.09	1.00	.39
5½" x 5½"	7.59	3.69	2.69	1.99	1.95	1.45	1.25	1.20	1.09	.49

PRICE PER EMBLEM FOR 100% EMBROIDERY

Quantity Approx. Sizes	20	50	100	200	300	500	1000	2000	3000	Heat Seal (Add. each)
2½" x 2½"	4.59	2.39	1.89	1.35	1.15	1.05	.75	.70	.58	.10
3" x 3"	4.89	2.49	2.09	1.45	1.29	1.15	.85	.75	.62	.15
3½" x 3½"	5.49	3.25	2.29	1.55	1.35	1.19	.93	.82	.72	.19
4" x 4"	6.09	3.49	2.39	1.65	1.49	1.29	1.03	.92	.82	.25
4½" x 4½"	6.59	3.60	2.49	1.75	1.55	1.35	1.15	1.10	1.02	.29
5" x 5"	7.09	3.70	2.59	1.90	1.95	1.45	1.33	1.24	1.16	.39
5½" x 5½"	7.69	3.80	2.79	2.15	2.05	1.49	1.4	1.29	1.21	.49



Background is solid material in one color.



**35-85%
EMBROIDERY
SAMPLES**

**100%
EMBROIDERY
SAMPLES**

Entire image is stitched in color.



ALSO CHECKOUT OUR WEB SITE AT WWW.UNIFORMS4ALL.COM

Tel: (877) 643-1100 ---- Toll Free
Fax: (877) 700-4477 ---- Toll Free

(818) 341-1500 (US & NON US calls)
(818) 341-0015 (US & NON US calls)

Phone Ordering Only
M-F 7:30am - 5:00pm PST
Sat 9am - 2pm PST

OR CHOOSE FROM ONE OF OUR MANY DESIGNER LAYOUTS



CP-03



CP-05



CP-06



CP-07



CP-09



CP-11



CP-12



CP-13



CP-14



CP-15



CP-16



CP-17



CP-18



CP-19



CP-21



CP-27



CP-28



CP-30



CP-32



CP-36



CP-38



CP-39



CP-41



CP-40



CP-34



CP-37



CP-42



CP-43



CP-44



CP-45



CP-46



CP-47



CP-48



CP-50



CP-51



CP-52



CP-53



CP-101



CP-60

The numbers on this page are design numbers not product order numbers. Choose a design and give the number to the artist when discussing creating your own emblem.

All prices subject to change. Any pictorial or typographical errors subject to correction when an order is placed. Proof of occupation is required for purchase of any law enforcement items.

UAW WILL MATCH COMPETITORS PUBLISHED PRICES

SHOULDER EMBLEMS

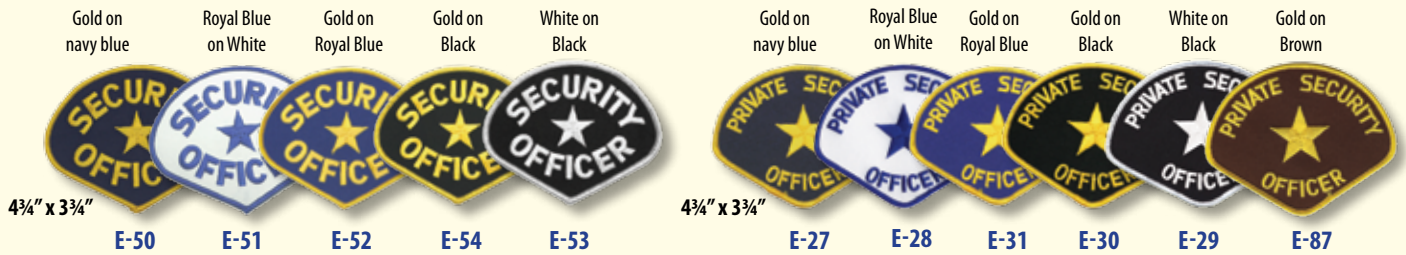

99¢ each



99¢ each

LOOK ONLINE 
for a complete selection

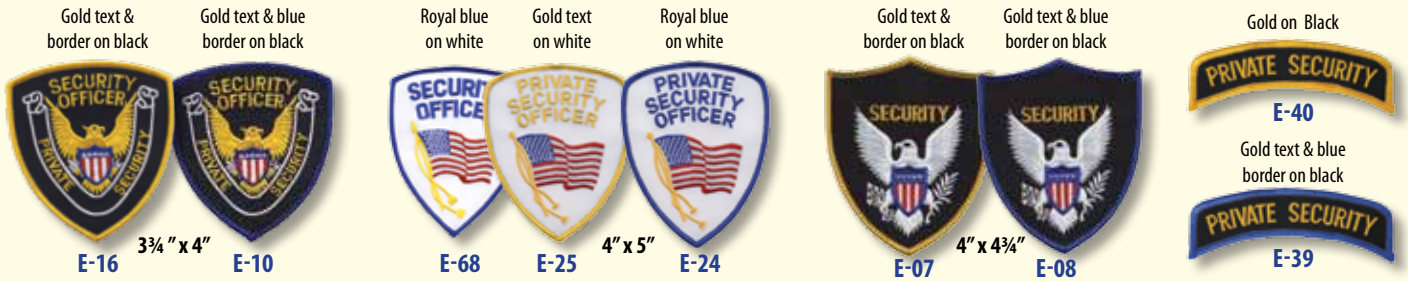

CHEST/CAP EMBLEMS



99¢ each

CHEST EMBLEMS



LAW ENFORCEMENT EMBLEMS*

MOTOR ESCORT EMBLEMS



\$199 each



GOLD 2-1/4" X 1-1/8" E-42



MOTOR WINGS - GOLD 2 3/4" X 1 1/4" E-85



FACING RIGHT 2-1/4" X 1-3/4" E-44



GREY 2-1/4" X 1-1/8" E-43



MOTOR WINGS - SILVER 2 3/4" X 1 1/4" E-86



FACING LEFT 2-1/4" X 1-3/4" E-45

*Proof of occupation required for these purchases.

SHERIFF EMBLEMS*

CA DEPT OF CORRECTIONS*



\$199 each

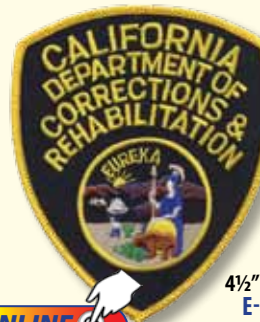

\$199 each

LOS ANGELES POLICE*

LOOK ONLINE for a complete selection



\$199 each



EMT EMBLEMS



\$199 each



PUBLIC SAFETY EMBLEMS



99¢ each



NEW



\$299 each



All prices subject to change. Any pictorial or typographical errors subject to correction when an order is placed. Proof of occupation is required for purchase of any law enforcement items.

UAW WILL MATCH COMPETITORS PUBLISHED PRICES

CHEST/CAP EMBLEMS



E-103

E-104

\$1.99 each
2½" x 2½"



E-105

E-106



E-107

E-108

LARGE EMBROIDERED CUSTOM EMBLEMS

WE OFFER HIGH QUALITY CUSTOM VERSIONS OF OUR LARGE TEXT EMBLEMS

*Price per emblem

*These emblems are text only.



LOOK ONLINE
for a complete selection

SIZE	6-10	11-20	21-50	51-100	101-200	201-500	501-1000	1001-2000	2001-3000	3001+
10X2	\$14.99	\$9.99	\$7.99	\$5.49	\$4.49	\$2.92	\$1.90	\$1.62	\$1.38	\$1.17
10X3	\$15.99	\$10.99	\$8.49	\$5.99	\$4.99	\$3.25	\$2.11	\$1.79	\$1.52	\$1.29
10X4	\$16.99	\$11.99	\$8.99	\$6.49	\$5.49	\$3.57	\$2.32	\$1.97	\$1.67	\$1.42
10X5	\$17.99	\$12.99	\$9.49	\$6.99	\$5.99	\$3.90	\$2.53	\$2.15	\$1.83	\$1.56
11X2	\$15.99	\$10.99	\$8.49	\$5.99	\$4.99	\$3.25	\$2.11	\$1.79	\$1.52	\$1.29
11X3	\$16.99	\$11.99	\$9.49	\$6.99	\$5.99	\$3.90	\$2.53	\$2.15	\$1.83	\$1.56
11X4	\$17.99	\$12.99	\$9.99	\$7.49	\$6.49	\$4.22	\$2.74	\$2.33	\$1.98	\$1.68
11X5	\$18.99	\$13.49	\$10.49	\$7.99	\$6.99	\$4.55	\$2.96	\$2.51	\$2.13	\$1.81
12X2	\$16.99	\$11.99	\$9.49	\$6.99	\$5.99	\$3.90	\$2.53	\$2.15	\$1.83	\$1.56
12X3	\$17.99	\$12.99	\$10.49	\$7.99	\$6.99	\$4.55	\$2.95	\$2.51	\$2.13	\$1.81
12X4	\$18.99	\$13.99	\$10.99	\$8.49	\$7.49	\$4.87	\$3.16	\$2.69	\$2.29	\$1.95
12X5	\$19.99	\$14.49	\$11.49	\$8.99	\$7.99	\$5.19	\$3.38	\$2.87	\$2.44	\$2.07
13X2	\$17.99	\$12.99	\$10.49	\$7.99	\$6.99	\$4.55	\$2.95	\$2.51	\$2.13	\$1.81
13X3	\$18.99	\$13.99	\$10.99	\$8.49	\$7.49	\$4.87	\$3.16	\$2.69	\$2.29	\$1.95
13X4	\$19.99	\$14.99	\$11.49	\$9.49	\$8.49	\$5.52	\$3.59	\$3.05	\$2.59	\$2.20
13X5	\$20.99	\$15.99	\$11.49	\$9.99	\$8.99	\$5.85	\$3.80	\$3.23	\$2.75	\$2.34
14X2	\$18.99	\$13.99	\$10.99	\$8.49	\$7.49	\$4.87	\$3.16	\$2.69	\$2.29	\$1.95
14X3	\$19.99	\$14.99	\$11.49	\$9.49	\$8.49	\$5.52	\$3.59	\$3.05	\$2.59	\$2.20
14X4	\$20.99	\$15.99	\$11.99	\$9.99	\$8.99	\$5.85	\$3.80	\$3.23	\$2.75	\$2.34
14X5	\$21.99	\$16.49	\$12.49	\$9.49	\$8.49	\$5.52	\$3.59	\$3.05	\$2.59	\$2.20

Tel: (877) 643-1100 ---- Toll Free
Fax: (877) 700-4477 ---- Toll Free

(818) 341-1500 (US & NON US calls)
(818) 341-0015 (US & NON US calls)

Phone Ordering Only
M-F 7:30am - 5:00pm PST
Sat 9am - 2pm PST

LARGE EMBROIDERED STOCK EMBLEMS

(Limited items now available in Spanish)

Proof of occupation is required for all law enforcement emblems.



GOLD E-35

\$3⁹⁹ each



BLUE E-80



WHITE E-36

All these emblems: 11" x 4"
All lettering is 3" high



GOLD E-79



RED E-75



GOLD ON BROWN E-46



BLUE E-47

*For a complete selection
LOOK ONLINE*



GOLD E-78



GOLD ON BROWN E-81



WHITE E-76

\$2⁴⁹ each



WHITE ON BLACK E-200



GOLD ON BLACK E-100



YELLOW ON NAVY BLUE E-23



WHITE ON NAVY BLUE E-32

SLIP-ON EPAULETS FOR SHIRTS & JACKETS

High quality slip on style epaulets for shirts and jackets.

Size: 4" x 2 1/4"



Gold on black E-67

\$4⁹⁹ per pair

Call for volume discount



Silver on black E-66

CUSTOMIZE YOUR OWN EPAULETS

Size: 4" x 2 1/4"



ECEP-02
Gold on black Plain



ECEP-04
Gold on black Plain w/ Flag



ECEP-05
Silver on black w/Flag



ECEP-03
Silver on black Plain

Custom Epaulets	10 pcs	25 pcs	50 pcs	
Price	\$7.49	\$5.49	\$4.90	per pair

All prices subject to change. Any pictorial or typographical errors subject to correction when an order is placed.

Proof of occupation is required for purchase of any law enforcement items.

UAW WILL MATCH COMPETITORS PUBLISHED PRICES

CHOOSE FROM OUR VARIETY OF RANK CHEVRONS

**99¢
each**



STAFF SGT. CHEVRONS

4 3/4" x 3 1/2"



**\$1.99
each**



**For a complete selection
LOOK ONLINE**

Tel: (877) 643-1100 ---- Toll Free
Fax: (877) 700-4477 ---- Toll Free

(818) 341-1500 (US & NON US calls)
(818) 341-0015 (US & NON US calls)

Phone Ordering Only
M-F 7:30am - 5:00pm PST
Sat 9am - 2pm PST

LAPD RANK CHEVRONS

• Los Angeles Police Dept. Spec • Silver Gray Stripe on Black • Sold in pairs - Priced as a pair

\$2.99
per pair



EC-69
SILVER/BLACK
3" x 3 1/2"

EC-45
SILVER/BLACK
3 1/2" x 3 1/8"

EC-46
SILVER/BLACK
3 3/4" x 3 1/8"

EC-47
SILVER/BLACK
4" x 3 1/8"

EC-48
SILVER/BLACK
4" x 3 1/8"

EC-49
SILVER/BLACK
4" x 3 1/8"

EC-50
SILVER/BLACK
4" x 3 1/8"

CHOOSE FROM OUR VARIETY OF HASHMARKS

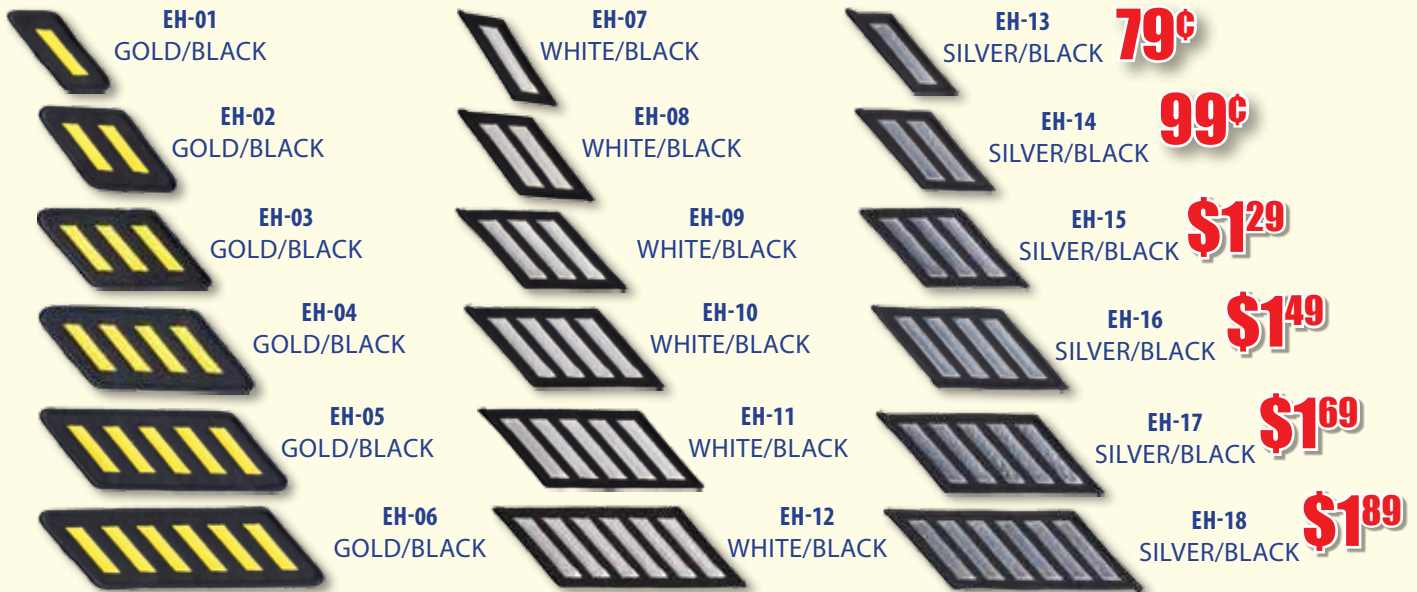

EH-01
GOLD/BLACK

EH-02
GOLD/BLACK

EH-03
GOLD/BLACK

EH-04
GOLD/BLACK

EH-05
GOLD/BLACK

EH-06
GOLD/BLACK

EH-07
WHITE/BLACK

EH-08
WHITE/BLACK

EH-09
WHITE/BLACK

EH-10
WHITE/BLACK

EH-11
WHITE/BLACK

EH-12
WHITE/BLACK

EH-13
SILVER/BLACK

EH-14
SILVER/BLACK

EH-15
SILVER/BLACK

EH-16
SILVER/BLACK

EH-17
SILVER/BLACK

EH-18
SILVER/BLACK

79¢

99¢

\$1.29

\$1.49

\$1.69

\$1.89

For a complete selection
LOOK ONLINE



EH-19
BLUE/TAN
YELLOW LINE

79¢

EH-20
BLUE/TAN
YELLOW LINE

99¢

EH-21
BLUE/TAN
YELLOW LINE

\$1.29

EH-22
BLUE/TAN
YELLOW LINE

\$1.49

EH-23
BLUE/TAN
YELLOW LINE

\$1.69

EH-24
BLUE/TAN
YELLOW LINE

\$1.89

All prices subject to change. Any pictorial or typographical errors subject to correction when an order is placed.
Proof of occupation is required for purchase of any law enforcement items.

UAW WILL MATCH COMPETITORS PUBLISHED PRICES

INSIGNIAS AND ACCESSORIES

Drill Whistle



\$1⁹⁹ ea WH-03 Gold WH-01 Silver

Snake Whistle Chains



\$1⁹⁹ ea IN-07 Gold IN-10 Silver

Linked Whistle Chains



\$1⁹⁹ ea IN-09 Gold IN-08 Silver

Whistle Hook with Clutch back

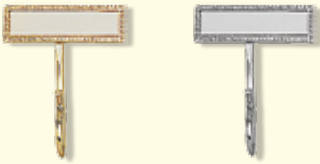

\$1⁹⁹ ea HK-01 Gold HK-02 Silver

Handcuff Tie Clip

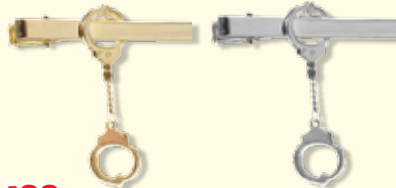

\$1⁹⁹ ea IN-19 Gold IN-20 Silver

Plain Tie Clip



\$1⁹⁹ ea IN-39 Gold IN-30 Silver

Large Sgt. Chevrons 1" x 3/4"



99¢ ea IN-15 Gold IN-16 Silver

Small Sgt. Chevrons 3/4" x 3/4"

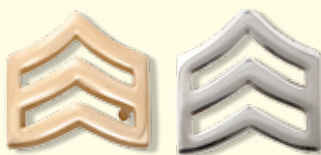

99¢ ea IN-23 Gold IN-24 Silver

Lieutenant Bars

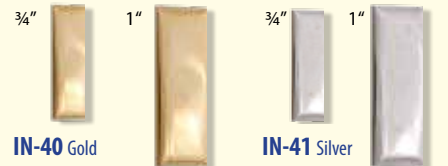

99¢ ea IN-40 Gold IN-21 Gold IN-41 Silver IN-22 Silver

Large Corporal Chevrons 1" x 3/4"



99¢ ea IN-17 Gold IN-18 Silver

Small Corporal Chevrons 1" x 1/2"



99¢ ea IN-25 Gold IN-26 Silver

Private Stripe 3/4" Long



\$1⁹⁹ ea

Major Pins

1 1/8" x 1"

1" x 3/4"



\$1⁹⁹ ea IN-27 Gold IN-28 Silver IN-88 Gold IN-89 Silver

Large Captain Bars 1" x 1"



99¢ ea IN-13 Gold IN-14 Silver

Small Captain Bars 3/4" x 3/4"



99¢ ea IN-03 Gold IN-04 Silver

Ribbon Flag 1" high



99¢ ea US-02

Rectangle Flag

1 3/4" x 1/4"



\$1⁹⁹ ea US-04

1 1/2" x 3/8"



\$1⁹⁹ ea



Rectangle Flag

1" x 3/4"











































99¢ ea US-01

Wavy Flag 3/4" x 3/4"



99¢ ea US-03

INSIGNIA AND ACCESSORIES

<p>Police Pin 3/8"</p> <p> IN-52 Gold</p> <p> IN-53 Silver</p> <p>\$199 ea</p>	<p>Officer Pin - 1/4"</p> <p> IN-54 Gold</p> <p> IN-55 Silver</p> <p>\$199 ea</p>	<p>Deputy Pin - 1/4"</p> <p> IN-56 Gold</p> <p> IN-57 Silver</p> <p>\$199 ea</p>	
<p>Sheriff Pin 1/4"</p> <p> IN-58 Gold</p> <p> IN-59 Silver</p> <p>\$199 ea</p>	<p>Chief Pin - 3/8"</p> <p> IN-60 Gold</p> <p> IN-61 Silver</p> <p>\$199 ea</p>	<p>Security Pin - 1/4"</p> <p> IN-05 Gold</p> <p> IN-06 Silver</p> <p>\$199 ea</p>	
<p>SO Pin - 1/2"</p> <p> IN-50 Gold</p> <p> IN-51 Silver</p> <p>99c ea</p> <p>HOT ITEM</p>	<p>PD Pin - 1/2"</p> <p> IN-62 Gold</p> <p> IN-63 Silver</p> <p>\$199 ea</p>	<p>FD Pin - 3/8"</p> <p> IN-64 Gold</p> <p> IN-65 Silver</p> <p>\$199 ea</p>	<p>K-9 Pin - 1/2"</p> <p> IN-66 Gold</p> <p> IN-67 Silver</p> <p>\$199 ea</p>
<p>SP Pin - 1/2"</p> <p> IN-68 Gold</p> <p> IN-69 Silver</p> <p>\$199 ea</p>	<p>Swat Pin - 3/8"</p> <p> IN-70 Gold</p> <p> IN-71 Silver</p> <p>\$199 ea</p>	<p>EMT Pin - 3/8"</p> <p> IN-72 Gold</p> <p> IN-73 Silver</p> <p>\$199 ea</p>	<p>EMS Pin - 3/8"</p> <p> IN-74 Gold</p> <p> IN-75 Silver</p> <p>\$199 ea</p>
<p>Fire Bugle - Lieutenant - 3/4"</p> <p> IN-76 Gold</p> <p> IN-77 Silver</p> <p>\$199 ea</p>	<p>Fire Bugle - Captain 1 - 3/4"</p> <p> IN-78 Gold</p> <p> IN-79 Silver</p> <p>\$199 ea</p>	<p>Fire Bugle - Captain 2 - 3/4"</p> <p> IN-80 Gold</p> <p> IN-81 Silver</p> <p>\$199 ea</p>	
<p>Fire Bugle - Asst. Chief - 3/4"</p> <p> IN-82 Gold</p> <p> IN-83 Silver</p> <p>\$199 ea</p>	<p>Fire Bugle - Dept. Chief - 3/4"</p> <p> IN-84 Gold</p> <p> IN-85 Silver</p> <p>\$199 ea</p>	<p>Fire Bugle - Chief - 3/4"</p> <p> IN-86 Gold</p> <p> IN-87 Silver</p> <p>\$199 ea</p>	

All prices subject to change. Any pictorial or typographical errors subject to correction when an order is placed.

Proof of occupation is required for purchase of any law enforcement items.

UAW WILL MATCH COMPETITORS PUBLISHED PRICES

OFFICER RANK INSIGNIAS

Large & Small Single Captain Stars

½" x ½" ¼" x ¼"

IN-01 Gold IN-02 Silver IN-11 Gold IN-12 Silver

99¢ ea

Two Stars

IN-32 Gold IN-33 Silver

\$2.99 ea 1" Long

Three Stars

IN-34 Gold IN-35 Silver

\$2.99 ea 2" Long

Four Stars

IN-36 Gold IN-37 Silver

\$2.99 ea 2 1/8" Long

Five Stars

IN-42 Gold IN-43 Silver

\$2.99 ea 1 1/8" Diameter

Blank Name Tags w/ back clutch

NT-01 Gold NT-02 Silver

\$2.99 ea We engrave see page 109-110

Security Hat Badge (Gold)

1 1/2" x 2 1/2"

\$14.99

Security Officer Hat Badge (Gold)

2 3/4" x 2 1/2"

BA-34 **\$14.99**

Mourning Band

Stretches to fit your badge

MB-01 **\$1.99**

Motor Officer Pins - 1 1/4" x 1"

IN-95G Gold

\$2.99 ea

IN-96S Silver

For a complete selection **LOOK ONLINE**

CUSTOM EMBROIDERED NAMETAPES

Can be tailored on your shirts or jackets.

- Nametape is 1" high X 8 1/2" long
- Lettering size: 1-line is 3/4"
- Lettering size: 2-line is 3/8"

\$5.99 ea

Tape colors available:

Black, Navy Blue, Sand, Olive Drab

Text colors available:

Black, White, Gold, Light Blue, Navy Blue, Red, Gray, Yellow, Green, Orange, Light Grey, Dark Grey

Specify tape color and text color when ordering.

Minimum order is 2 nametapes with same lettering.

NEW ITEMS



Tape color	Black	Navy Blue	Sand	Olive Drab
1 Line	NT-30B	NT-30N	NT-30S	NT-30G
2 Lines	NT-40B	NT-40N	NT-40S	NT-40G

Tel: (877) 643-1100 ---- Toll Free
Fax: (877) 700-4477 ---- Toll Free

(818) 341-1500 (US & NON US calls)
(818) 341-0015 (US & NON US calls)

Phone Ordering Only
 M-F 7:30am - 5:00pm PST
 Sat 9am - 2pm PST

TWO TONE ENGRAVED NAME TAGS

Our two tone name tags have a brushed silver border with a polished gold center.

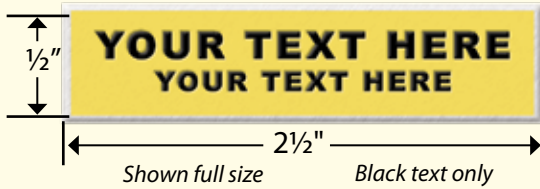

\$7⁹⁹
Each

GOLD/Silver	Pin Back	Clutch Back	Magnet Back
	NT-19G	NT-20G	NT-21G

Production time: 2 days to 1 week

ENGRAVED CROSS NAME TAGS AND TIE TACKS

A very simple and inexpensive way to add a consistent identity to all of your personnel.



NT-22G: GOLD

\$8⁹⁹
Each



IN-90: GOLD

\$4⁹⁹
Each



NT-23S: SILVER



IN-91: SILVER

ENGRAVED "SERVING SINCE" NAME TAGS

These name tags have a polished gold surface.

We can engrave your one or two lines of text and the required date on these name tags.

GOLD	Pin Back	Clutch Back	Magnet Back
	NT-13G	NT-14G	NT-15G
SILVER	Pin Back	Clutch Back	Magnet Back
	NT-16S	NT-17S	NT-18S



Production time is 2 days to 1 week

\$9⁹⁹
Each

PATRIOTIC ENGRAVED NAME TAGS WITH USA FLAG

These name tags have a polished gold or silver surface and smooth rounded edges.

We can engrave your one or two lines of text on these patriotic name tags.

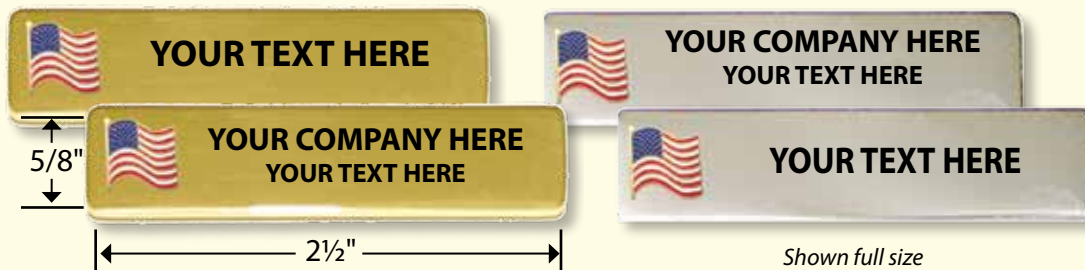

5/8" X 2 1/2" with US Flag

GOLD	Pin Back	Clutch Back	Magnet Back
	NT-07G	NT-08G	NT-09G
SILVER	Pin Back	Clutch Back	Magnet Back
	NT-10S	NT-11S	NT-12S

\$6⁹⁹
Each

Black text only

Production time is 1 week

All prices subject to change. Any pictorial or typographical errors subject to correction when an order is placed.

Proof of occupation is required for purchase of any law enforcement items.

UAW WILL MATCH COMPETITORS PUBLISHED PRICES

ENGRAVED NAME TAGS

We can engrave your one or two lines of text on these name tags.

\$6⁹⁹
Each

5/8" X 2 1/2"

Production time is 2 days - 1 week



GOLD	Pin Back	Clutch Back	Magnate Back
	NT-01G	NT-04G	NT-03G
SILVER	Pin Back	Clutch Back	Magnate Back
	NT-02S	NT-05S	NT-06S

PORTABLE SECURITY BOOTH

Perfect for: ➤ Security/Guard Personnel ➤ Parking Booth
 ➤ Perimeter Security ➤ Cashier Booth ➤ Guard Booth ➤ Ticket Booth
 ➤ Car wash attendant Booth ➤ School Security



- Anodized finish is resistant to rusting or surface deterioration
- Insulated wood panels
- Outside Dimensions: 4'W x 5'L x 7 1/4'H
- Sliding windows on three sides allow greater flexibility
- 1-3/4" thick anodized swing door with lock provides additional security • 34" window sill height makes transactions fast and convenient
- Option of electrical outlet for appliances (Electrical wiring required)

MSRP \$4000⁰⁰

\$1,999⁹⁹

+ Shipping and Handling Charges

SB-06

This durable and convenient portable booth comes pre-assembled. Please call 1-877-643-1100 (8am-5pm PST Mon-Fri) for shipping cost to your location.



Call about adding electricity and air conditioning to this booth.

Call for complete information on our new line of security booths.

Tel: (877) 643-1100 ---- Toll Free
 Fax: (877) 700-4477 ---- Toll Free

(818) 341-1500 (US & NON US calls)
 (818) 341-0015 (US & NON US calls)

Phone Ordering Only
 M-F 7:30am - 5:00pm PST
 Sat 9am - 2pm PST



CALL OR EMAIL US TO DISCUSS YOUR NEEDS
 INFO@UNIFORMS4ALL.COM

We offer a variety of custom lettering. Our new heat press designs are a great option!

MINIMUM ORDER
 12 minimum items per order. Costs vary depending on design details and colors.

Stitches \ Quantity	12-35	36-71	72-99	100-999	1000+
0-5999	\$4.99	\$3.99	\$2.99	\$1.99	\$1.50
6000-8999	\$5.99	\$4.99	\$3.99	\$2.50	\$2.19
9000-12,999	\$6.99	\$5.99	\$4.99	\$3.50	\$2.99
13,000-14,999	\$7.99	\$6.99	\$5.99	\$4.50	\$3.50
15,000-19000	\$8.99	\$7.99	\$6.99	\$4.99	\$4.50

BASIC SERVICES

- All designs** must be approved by the customer via email or fax.
- Digitizing setup fee** is based on complexity of the design and number of colors chosen
- Setup cost** is based on the complexity of the design and the number of colors
- Placement** at every location on a garment is a separate charge.
- Beanies/Ball caps:** \$8.99 price includes the beanie or cap. Call for details.
- Production time:** most orders ready to ship in 7 business days.
- Customized orders** can not be returned or exchanged. All sales are final.
- All customized orders:** we recommend dry cleaning for longer use.
- Proof of occupation** is required for all law enforcement requests.

NO FREE SAMPLES



SILK SCREEN SERVICES

Add your company name, officer rank and name, or customized identifications on SHIRTS and JACKETS.



Location \ Quantity*	12-24	25-50	51-100	100-300	300-1,000
Front/Chest Only	\$5.99	\$4.99	\$3.99	\$2.99	\$1.99
Back Only	\$5.99	\$4.99	\$3.99	\$2.99	\$1.99
Both	\$9.99	\$8.99	\$5.99	\$4.99	\$2.99

- All designs** must be approved (by the customer via email or fax).
- Setup cost** A one time fee of \$50.00 for each size. Black or White inks only. Other colors can be used at additional costs.
- Placement** every location on a garment is a separate charge.
- Sizes available:** Front: up to 3" H x 5" W Back: up to 6" H x 12" W Size(s) determines the final price
- Production time:** most orders ready to ship in 7 business days.
- Customized orders** can not be returned or exchanged. All sales are final
- Proof of occupation** is required for all law enforcement requests.

MINIMUM ORDER
 12 minimum items per order. Costs vary depending on design details and colors.

NO FREE SAMPLES

All prices subject to change. Any pictorial or typographical errors subject to correction when an order is placed. Proof of occupation is required for purchase of any law enforcement items.

WE WILL MATCH COMPETITORS PUBLISHED PRICES

UHF/VHF NARROW BAND RADIOS

Heavy duty commercial programmable radio incorporates the latest advanced technology. The radio comes pre-programmed and can be reprogrammed to your specification by purchasing the programming cable and downloading the free software from our web site. Features 16 channels. Comes with antenna, wrist loop, belt clip, battery, charger & adapter.

Standard Specification:

- Frequency: Available in UHF (450-470 MHz) or VHF (136-174 MHz)
- RF Power: 5W
- Range: 2 to 3 miles
- 7.2v 1500mAh Li-ion battery
- Compatible with most 2 prong Kenwood headsets and accessories



\$99⁹⁹



Lithium-ion Battery



Charger

- UANB-400 UHF NARROW BAND***
- UANB-401 VHF NARROW BAND***

* Complies with FCC narrowband requirements. The FCC has mandated that all non-federal public safety licensees using wideband radio systems migrate to narrowband by January 1, 2013

Also available as replacement parts

- Lithium-ion Charger: UAC-400 \$19.99**
- Lithium-ion Battery: BAT-400 \$19.99**

RAPID LI-ION BATTERY CHARGING STATIONS

• This station will charge UAW UA400 & UA401 radios • Heavy duty steel construction • Indicator LED changes color when radio is completely charged • Charge time: Approx 3 hours for standard Li-ion 1500mAh battery • Input: AC 110V, Output: DC 12V, 500-600Ma

6 radio charging station



\$129⁹⁹

UAC-08



8 radio charging station

\$149⁹⁹

UAC-09



RADIO HOLDERS



SYNTHETIC LEATHER

▲ **SL-11**

\$9⁹⁹



BASKET WEAVE LEATHER

▲ **L-11**

\$9⁹⁹



PLAIN LEATHER

▲ **P-11**

\$9⁹⁹



UNIVERSAL HOLDER

NYLON N-26

BW LEATHER L-26

SYNTHETIC LEATHER SL-26

\$9⁹⁹



NYLON

▲ **N-25**

\$9⁹⁹

Tel: (877) 643-1100 ---- Toll Free
Fax: (877) 700-4477 ---- Toll Free

(818) 341-1500 (US & NON US calls)
(818) 341-0015 (US & NON US calls)

Phone Ordering Only
 M-F 7:30am - 5:00pm PST
 Sat 9am - 2pm PST

COMPACT PROGRAMMABLE UHF/VHF RADIO



- Compact size
- Output Power 5W/1W
- Range: 2 to 3 miles
- 15 Channels plus 1 Scan Channel
- CTCSS/DTCS
- Computer Programmable
- Frequency Range: 450-470 MHz
- 7.2v 1100mAh Li-ion battery
- Compatible with most 2 prong Kenwood headsets and accessories
 - Low Battery Warning
 - Includes Desktop charger, Battery, Antenna & Belt Clip
 - Dimension : 4" H x 2" W x 1" D (exclusive of antenna)

\$79⁹⁹

◀ **UHF: UA-300**
VHF: UA-301



\$149⁹⁹

▶ **Charger: UAC-306**

Note: The UAW Radio comes pre-programmed. If you wish to re-program the UAW Radio, please purchase the programming cable and download the free software from our web site

Also available as replacement parts

1 Charger: UAC-300 for UA-300 & 301	\$19.99
6 Charger: UAC-306 for UA-300 & 301	\$149.99
Battery: BAT-300	\$19.99
Programming cable: UAW-C	\$9.99
Radio software CD: UAW-S	\$9.99

COMMERCIAL PROGRAMMABLE UHF/VHF 2-WAY RADIO



Designed for heavy duty use. The radio comes pre-programmed and can be reprogrammed to your specification by purchasing the programming cable and downloading the free software from our web site. Includes 1500 mAh battery, desktop charger, antenna and belt clip.

Specifications:

- Frequency: 450-470 MHz(UHF), 150-174MHz(VHF)
- Compatible with most 2 prong Kenwood headsets & accessories
- 16 channels
- Built in tone signaling - CTCSS/DTCS
- Range: 2 to 3 miles
- RF Power: 5 watts



▶ **Charger Unit**



▶ **Battery**

Also available as replacement parts

Charger: UAC-01	\$19.99
Battery: BAT-100	\$19.99
Programming cable: UAW-C	\$9.99
Radio software CD: UAW-S	\$9.99*

*Software also available as a free download form our web site

◀ **UHF UA-500 NARROW BAND**
VHF UA-501 NARROW BAND

MSRP \$259⁹⁵
\$69⁹⁹ each



RAPID 6 NIMH BATTERY CHARGING STATION

- This recharging station will charge up to 6 UAW UA01, UA100/200/500/501 radios at the same time
- Heavy duty steel construction
- Indicator LED changes color when radio is completely charged
- Charge time: Approx 3 hours for standard NiMH 1500mAh battery
- Input: AC 110V, Output: DC 12V, 500-600mA
- Dimensions: 12" W x 9 1/2" D x 4" H



▶ **UAC-05**
\$99⁹⁹

All prices subject to change. Any pictorial or typographical errors subject to correction when an order is placed.

Proof of occupation is required for purchase of any law enforcement items.

UAW WILL MATCH ALL COMPETITORS PUBLISHED PRICES

MOTOROLA PROFESSIONAL UHF RADIOS

• Designed for everyday heavy duty use • 450-470 MHz • Allows for total private communication • Compatible with most other UHF radios • Includes desktop charger, battery and belt clip

	2 Channel	8 Channel	16 Channel
Range	Up to 250,000 square feet (20 floors)	Up to 250,000 square feet (20 floors)	Up to 350,000 square feet (30 floors)
Battery life	Up to 12 hours	Up to 12 hours	Up to 18.5 hours
Power	2 Watts	2 Watts	4 Watts



- ▲ **2 Channel** MOT-01 **\$239⁹⁹**
- 8 Channel** MOT-02 **\$269⁹⁹**
- 16 Channel** MOT-03 **\$319⁹⁹**



NEW

Free! Your choice of head set or mic.
 UA-22 or UA-19
 (see pages 114 & 116)

RADIO SPEAKER MICROPHONES

LIGHTWEIGHT REMOTE SPEAKER MIC

• Fits UAW and 2 prong Kenwood radios • Strain relief cable for maximum durability • 360 swivel clip • 3.5mm accessory jack

UA-18: Fits UAW & most 2 prong Kenwood radios
UA-19: Fits most 2 prong Motorola radios

\$12⁹⁹ each



HEAVY DUTY REMOTE SPEAKER MIC

• Strain relief cable for maximum durability • 360° swivel clip • 3.5mm accessory jack

UA-16

Fits UAW & most 2 prong Kenwood radios

UA-17

Fits most 2 prong Motorola radios

\$19⁹⁹ each



MED DUTY REMOTE SPEAKER MIC

• Fits UAW and 2 prong Kenwood radios • Strain relief cable for maximum durability • 360 swivel clip • 3.5mm accessory jack

UA-28

Fits UAW & most 2 prong Kenwood radios

\$17⁹⁹ each



HEADSET ADAPTORS

Adapter allows you to use 2 prong Motorola earphones on Motorola radios with different jacks.

Fits Motorola radios:

HT750, HT1250, HT1500XLS, MTX8250LS, MTX950, MTX9250, EX500, EX600, GL200, GP140, GP320, GP340, GP344, GP380, GP388, GP640, GP680, GP1280, PRO5150, PRO7150



\$10⁹⁹ each
UA-20

Fits Motorola radios:

HT1000, MT2000, MTS2000, MTX838, MTX9000, MTX-LS, XTS2500, XTS3000, XTS3500 and XTS5000 and EF Johnson radios



\$19⁹⁹ each
UA-21

Fits Kenwood radios:

TK-280/380/480



\$19⁹⁹ each
UA-24

Tel: (877) 643-1100 ---- Toll Free
Fax: (877) 700-4477 ---- Toll Free

(818) 341-1500 (US & NON US calls)
(818) 341-0015 (US & NON US calls)

Phone Ordering Only
 M-F 7:30am - 5:00pm PST
 Sat 9am - 2pm PST

RADIO HEADSETS

EAR HANGER EARPHONE WITH VOX/PTT LAPEL MICROPHONE

- Adjustable earphone with in-line microphone
- Small PTT/VOX Switch (Choose between voice operation or push to talk)



\$10⁹⁹

UA-32

Fits UAW & most 2-prong Kenwood radios

UA-33

Fits most 2-prong Motorola radios

TACTICAL THROAT MIC WITH SURVEILLANCE EARPIECE

- Has surveillance style clear tube earphone
- Large lapel PTT with metal clip
- Highly sensitive vibration sensor uses induction to pick up voice signals through vibrations in the neck
- Ideal for loud environments



\$19⁹⁹

UA-30

Fits UAW & most 2-prong Kenwood radios

UA-31

Fits most 2-prong Motorola radios

LISTEN ONLY EAR HANGER EARPIECE

- Adjustable Ear Hanger Earphone
- Works with remote speaker microphones
- 3.5mm plug



\$10⁹⁹

UA-29

Fits UAW mics & most speaker mics with 3.5mm accessory jack

SURVEILLANCE EARPHONE WITH LAPEL MICROPHONE

- Fits HT1000 and XTS Series radios
- Works with radio transceivers
- Discreet lapel microphone with built-in push-to-talk (PTT) button
- Surveillance style clear tube earphone
- Lightweight, durable and highly concealable



\$24⁹⁹

UA-34

Fits HT1000 and XTS series Motorola radios

EARHANGER LAPEL MICROPHONE

- Fits HT1000 and XTS Series radios
- Discreet lapel microphone with built-in push-to-talk (PTT) button



\$19⁹⁹

UA-35

Fits HT1000 and XTS series Motorola radios

LIGHTWEIGHT REMOTE SPEAKER MICROPHONE

- Lightweight Remote Speaker Mic
- Fits HT1000 and XTS Series radios
- Fits UAW and 2 prong Kenwood radios
- Strain relief cable for maximum durability
- 360 swivel clip
- 3.5mm accessory jack



\$19⁹⁹

UA-36

RADIO HEADSET CONNECTOR CHART

Connectors	Manufacturer	Radio Models	Connectors	Manufacturer	Radio Models
2-Prong	UAW/Kenwood	UA300, UA301, UA400, UA401, UA500, UA501, TK-272/372, TK373, TK3100, Pro Talk XLS, TK-3131, TK259/359, TK250/360, TK270/370, TK2100/3100, TK2160/3160/3101, TK2102/3102, TK2170/3170/3173, TK2200/3200, TK3201	Multi-Prong	Motorola	GP900, GP9000, HT1000, MT1500, MT2000, MTS2000, MTX8000, MTX838, MTX900, MTX9000, MTX960, MTXLS, PR1500, XTS1500, XTS2000, XTS2500, XTS3000, XTS3500, XTS5000
2-Prong	Motorola	GP300, SP50, P110, P1225, LTS2000, CP88, CP125, CP150, CP200, CT150, CT250, CT450, GP308, P080, P2000, PRO3150, P040, P080, GP68, GP88, PR400, BPR40, GP350	3.5mm Listen Only		Motorola, Vertex & UAW speaker mics

All prices subject to change. Any pictorial or typographical errors subject to correction when an order is placed.

Proof of occupation is required for purchase of any law enforcement items.

UAW WILL MATCH ALL COMPETITORS PUBLISHED PRICES

RADIO HEADSETS

SURVEILLANCE EARPHONE WITH LAPEL MICROPHONE

- Discreet lapel microphone with built-in push-to-talk (PTT) button
- Surveillance style clear tube earphone
- Lightweight, durable and highly concealable



Fits UAW & most 2-prong Kenwood radios **UA-04** **\$11⁹⁹**
 Fits most 2-prong Motorola radios **UA-22** **\$11⁹⁹**

EARPHONE WITH BOOM MICROPHONE

- Adjustable earphone with flexible boom arm microphone
- In-line PTT button with clothing clip



Fits UAW & most 2-prong Kenwood radios **UA-05** **\$10⁹⁹**

EARHANGER WITH LAPEL MICROPHONE

- Discreet lapel microphone with built-in push-to-talk (PTT) button



Fits UAW & most 2-prong Kenwood radios **UA-02** **\$10⁹⁹**
 Fits most 2-prong Motorola radios **UA-23**

EARPHONE WITH LAPEL MICROPHONE

- Discreet lapel microphone with built-in push-to-talk (PTT) button
- Rugged polyurethane cable for maximum durability



Fits UAW & most 2-prong Kenwood radios **UA-06** **\$9⁹⁹**
 Fits most 2 prong Motorola radios **UA-07**

D-LOOP EARPHONE WITH BOOM MICROPHONE

- D-loop earphone with flexible boom arm microphone
- Discreet lapel microphone with built-in push-to-talk (PTT) button
- Rugged polyurethane cable for maximum durability



Fits UAW & most 2-prong Kenwood radios **UA-08** **\$10⁹⁹**
 Fits most 2 prong Motorola radios **UA-09**

LISTEN ONLY SURVEILLANCE EARPIECE

- Surveillance style clear tube earphone
- Works with remote speaker microphones
- 3.5mm plug



Fits UAW & most remote speakers with 3.5mm jacks **UA-10** **\$10⁹⁹**
 Fits most remote speakers with 2.5mm jacks **UA-38**

3-WIRE SURVEILLANCE EARPIECE

- Includes earphone, microphone and barrel PTT (push-to-talk) remote
- Surveillance style clear earphones
- Can be worn on lapel or sleeve
- Clip provides cable retention cut strain on earphone



Fits UAW & most 2-prong Kenwood radios **UA-11** **\$19⁹⁹**
 Fits most 2 prong Motorola radios **UA-12**

HEADSET WITH BOOM MICROPHONE

- Includes headset, boom microphone and in-line PTT button with clothing clip.



Fits UAW & most 2-prong Kenwood radios **UA-37** **\$9⁹⁹**

D-LOOP EARPHONE WITH LAPEL MICROPHONE

- D-loop earphone can be worn on either right or left ear
- Discreet lapel microphone with built-in push-to-talk (PTT) button
- Rugged polyurethane cable for maximum durability



Fits UAW & most 2-prong Kenwood radios **UA-14** **\$9⁹⁹**
 Fits most 2 prong Motorola radios **UA-15**

REPLACEMENT RADIO BATTERIES



- Replacement Battery for UAW Radio UA01/UA100/UA200/UA500/UA501
- NiMH 1500mAh

BAT-100
\$19⁹⁹



- Replacement Battery for Motorola Radio P110
- NiMH 1800 mAh

BAT-23
\$19⁹⁹



- Replacement battery for Motorola Radio HT1000/GP900/MTX838/MTX9000/MTX8000
- NiMH 1800 mAh

BAT-20
\$19⁹⁹



- Replacement Battery for Motorola Radio XTS3000/XTS3500
- NiMH 1700 mAh

BAT-26
\$24⁹⁹

- Replacement Battery for Kenwood Radio TK-250/TK-350
- NiMH 1600mAh



BAT-29
\$19⁹⁹

- Replacement Battery for UAW UA01/UA100/UA200 & Kenwood TK-260/360/270/370/2107/3107
- NiMH 1800 mAh



BAT-28
\$19⁹⁹

- Replacement Battery for Motorola Radio HT750/HT1250/GP340/GP320/GP328/PRO5150
- NiMH 1500 mAh



BAT-22
\$19⁹⁹



RADIO BAT-100
\$19⁹⁹

Fits only
UA-100/UA-200

- Replacement Battery for Motorola Radio GP88/GP300
- NiMH 1500 mAh



BAT-25
\$19⁹⁹

- Replacement Battery for Motorola Radio P1225
- NiMH 1800 mAh



BAT-24
\$29⁹⁹

- Replacement Battery for Motorola Radio XTN446
- NiMH 1500 mAh



BAT-27
\$19⁹⁹



BAT-1014
\$19⁹⁹

Use with Guardscan
GS1000

- Replacement Battery for Motorola Radio HT600/HT800/MT1000/MTX800/MTX900



BAT-21
\$19⁹⁹

- Replacement Battery for Kenwood Radio TK-280/290/380/390/480
- NiMH 1800mAh



BAT-30
\$19⁹⁹

- Replacement Battery for UA300 /301
- Li-ion 1100mAh



BAT-300
\$19⁹⁹



BAT-31
\$19⁹⁹

- Replacement Battery for Motorola CP 200
- NiHm 1600mAh

Item	Fits Radio Model#	Style	Description	Price
BAT-20	HT1000/GP900/MTX838/MTX9000/MTX8000	Motorola	NiMH 1800mAh	\$19.99
BAT-21	HT600/HT800/MT1000/MTX800/MTX900	Motorola	NiMH 1800mAh	\$19.99
BAT-22	HT750/HT1250/GP340/GP320/GP328/PRO5150	Motorola	NiMH 1500mAh	\$19.99
BAT-23	P110	Motorola	NiMH 1800mAh	\$19.99
BAT-24	P1225	Motorola	NiMH 1800mAh	\$29.99
BAT-25	GP88/GP300	Motorola	NiMH 1500mAh	\$19.99
BAT-26	XTS3000/XTS3500	Motorola	NiMH 1700mAh	\$24.99
BAT-27	XTN446/XTN446/XV1100/XV2100 XV2600/XU1100/XU2100/XU2600	Motorola	NiMH 1500mAh	\$19.99
BAT-28	TK-260/360/270/370/2107/3107/VA100/VA200/VA01	UAW & Kenwood	NiMH 1800mAh	\$19.99
BAT-29	TK-250/TK-350	Kenwood	NiMH 1600mAh	\$19.99
BAT-30	TK-280/290/380/390/480	Kenwood	NiMH 1800mAh	\$19.99
BAT-31	CP-200	Motorola	NiMH 1600mAh	\$19.99



All prices subject to change. Any pictorial or typographical errors subject to correction when an order is placed.

Proof of occupation is required for purchase of any law enforcement items.

UAW WILL MATCH ALL COMPETITORS PUBLISHED PRICES

STREAMLINED ULTRA SERIES HIGH INTENSITY

Incredible warning power! These LEDs are 20% brighter than standard LEDs

55" STREAMLINED ULTRA LED LIGHTBAR



- 26 High intensity LED modules
- Ultra slim profile and clear lens for stealth look
- Choose from 12 flash patterns
- Built-in amber arrowstick and brake lights on back

**NOW AVAILABLE IN SIZES UP TO 82"!
SEE OUR WEB SITE!**

46" STREAMLINED ULTRA LED LIGHTBARS



Lightbars are subject to oversize shipping cost



7 BUTTON CONTROL BOX



MSRP \$1979⁹⁹
PRICE REDUCTION NOW ONLY
\$499⁹⁹

Amber only
 Other colors available at \$39⁰⁰ extra

- 22 High intensity LED modules
- Ultra slim profile and clear lens for stealth look
- Choose from 12 flash patterns
- Built-in amber arrowstick on the back
- 2 LED take-down lights and 2 LED alley lights
- Includes gutter mounting kit and 7 button control box
- 12 foot power cord (12V DC)
- Size: 46"L x 12"W x 1.78"H



LED COLOR	ITEM #
	Amber LED-4005
	Red LED-4006
	Red/Blue LED-4007
	Green LED-4008
	Blue LED-4009

Replacement LED modules available in these colors:

A R B G □ \$29⁰⁰each LEM-10

Please specify color when ordering

Tel: (877) 643-1100 --- Toll Free
Fax: (877) 700-4477 --- Toll Free

(818) 341-1500 (US & NON US calls)
(818) 341-0015 (US & NON US calls)

Phone Ordering Only
 M-F 7:30am - 5:00pm PST
 Sat 9am - 2pm PST

TENSITY LED TOW TRUCK LIGHTS

ter than linear LEDs! The brightest LEDs on the market!

ULTRA LED LIGHTBARS

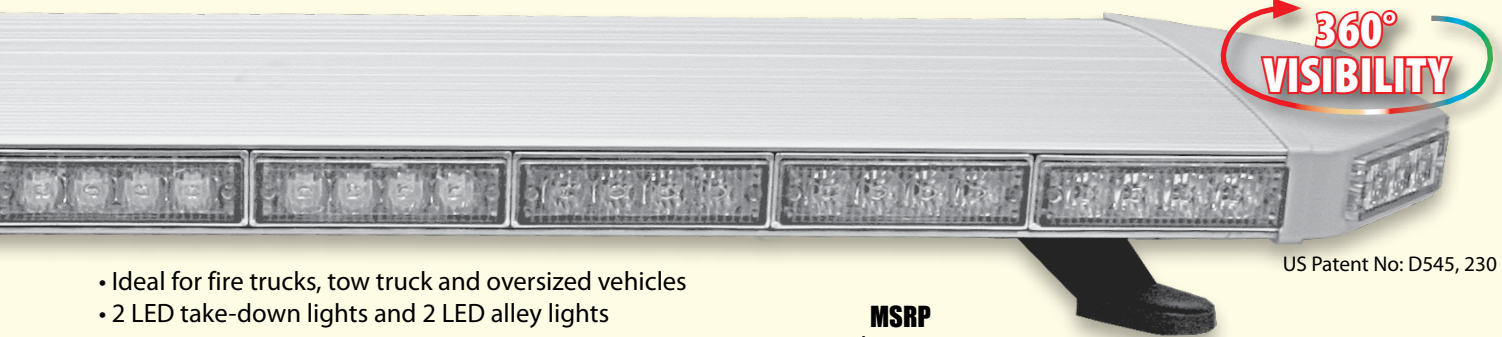

US Patent No: D545, 230

- Ideal for fire trucks, tow truck and oversized vehicles
- 2 LED take-down lights and 2 LED alley lights
- Includes universal gutter mounting kit and 7 button control box
- 12 foot power cord (12V DC)
- Size: 55"L x 12"W x 1.78"H

**VERY BRIGHT!
VERY AFFORDABLE!**

**MSRP
\$2605⁹⁹**

**PRICE REDUCTION
NOW ONLY
\$699⁹⁹**

Amber only

Other colors available at
\$49.⁰⁰ extra



7 BUTTON CONTROL BOX



LED COLOR	55" Version ITEM #
	Amber LED-4605
	Red LED-4606
	Red/Blue LED-4607
	Green LED-4608
	Blue LED-4609

Replacement LED modules available in these colors:

A R B G C \$29.⁰⁰each

27" & 18" STREAMLINED ULTRA MINI LED LIGHTBARS



Shown with lights turned off

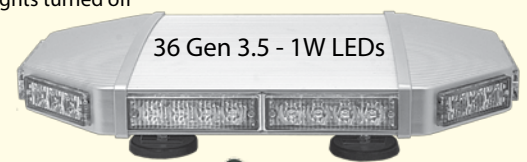

US Patent No: D545, 230



**MSRP
\$895⁹⁹**
**PRICE REDUCTION
NOW ONLY
\$299⁹⁹**

Amber only
Other colors available at
\$29.⁰⁰ extra

LED COLOR	ITEM #
Amber	LED-4055
Red	LED-4056
Red/Blue	LED-4057
Green	LED-4058
Blue	LED-4059

These lights use a cigarette adaptor plug

**PRICE REDUCTION
NOW ONLY
\$199⁹⁹**

Amber only
Other colors available at
\$29.⁰⁰ extra

LED COLOR	ITEM #
Amber	LED-4025
Red	LED-4026
Red/Blue	LED-4027
Green	LED-4028
Blue	LED-4029

- 14 High intensity LED modules
- Ultra slim profile and clear lens for stealth look
- Selectable flash patterns
- 2 LED alley lights
- Includes magnetic mount and 4 button control box
- Size: 27"L x 12"W x 1.78"H
- 12 foot power cord with cigarette adapter (12V DC)



- 10 High intensity LED modules
- Ultra slim profile and clear lens for stealth look
- Selectable flash patterns
- 2 LED alley lights
- Includes magnetic mount and 2 button control switch
- Size: 18"L x 12"W x 1.78"H
- 12 foot power cord with cigarette adapter (12V DC)

Lightbars are subject to oversize shipping cost

All prices subject to change. Any pictorial or typographical errors subject to correction when an order is placed. Proof of occupation is required for purchase of any law enforcement items.

UAW WILL MATCH COMPETITORS PUBLISHED PRICES

Shown with lights off

Front View

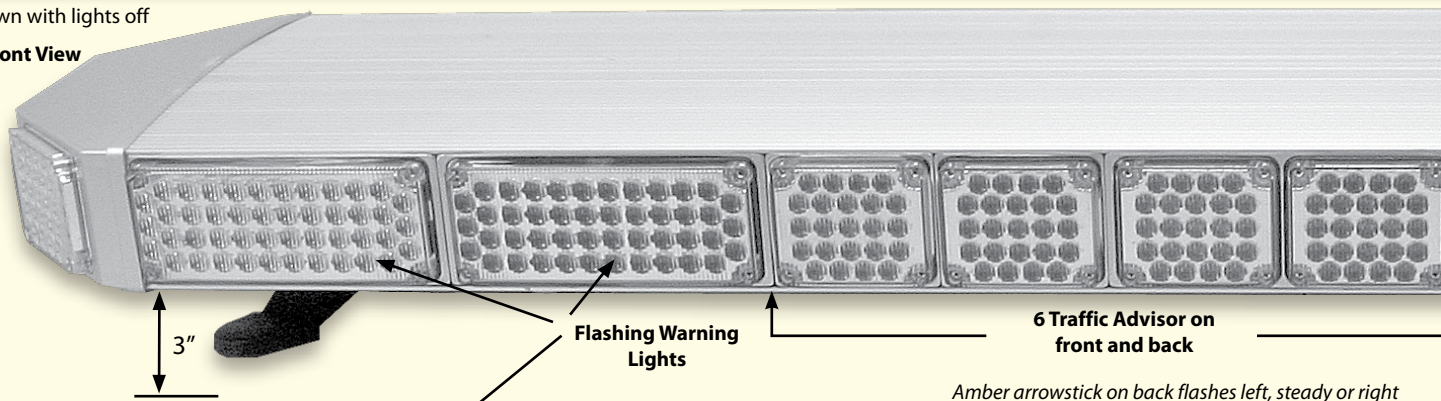

Flashing Warning Lights

6 Traffic Advisor on front and back

Amber arrowstick on back flashes left, steady or right

Rear View

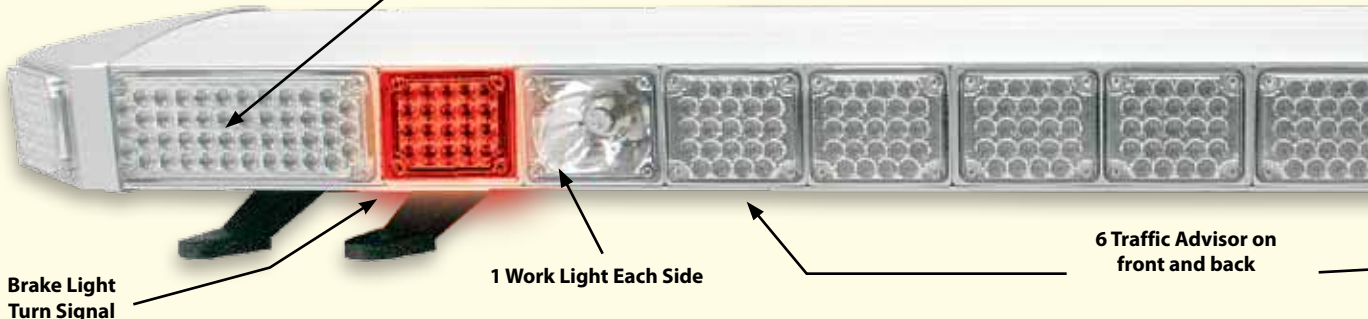

Brake Light Turn Signal

1 Work Light Each Side

6 Traffic Advisor on front and back

The Opti-Range series features clear lenses and clear LEDs to give an inconspicuous appearance when turned off. At the flick of a switch, the LEDs warn and illuminate with high intensity color light.

- 24 LED modules with 12 selectable flash patterns
- Built-in amber arrow stick
- 2 halogen take-down lights on front
- 2 halogen alley lights, each controlled independently
- Narrow side reflectors for increased visibility
- Aerodynamic design
- Hard anodized finish
- Gutter style mounting kit & 7 button control box
- 12 foot power cord
- Power: 12V DC

46" OPTI-RANGE STEALTH LED LIGHTBAR

16 modules

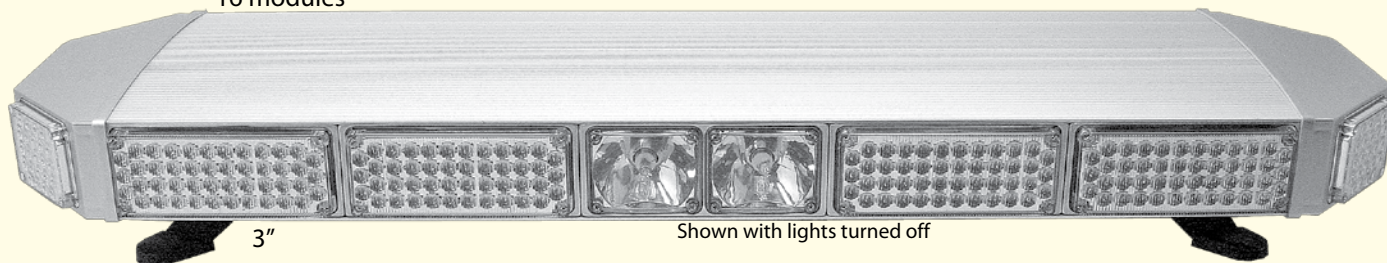

Shown with lights turned off

Lightbars are subject to oversize shipping cost

7 BUTTON CONTROL BOX



MSRP \$899⁹⁹
PRICE REDUCTION NOW ONLY
\$399⁹⁹

360° VISIBILITY

Amber only
 Other colors available at \$39⁰⁰ extra

- 16 LED modules with 12 selectable flash patterns
- Built-in amber arrowstick
- 2 halogen take-down lights on front
- 2 halogen alley lights, each controlled independently
- Narrow side reflectors for increased visibility
- Aerodynamic design with hard anodized finish
- Includes universal mounting kit and 7 button control box
- Size: 45½"L x 12"W x 3½"H x • 12 foot power cord • Power: 12V DC

LED COLOR	46" Version ITEM #
	Amber LED-65
	Red LED-66
	Red/Blue LED-67
	Green LED-68
	Blue LED-69

Tel: (877) 643-1100 ---- Toll Free
 Fax: (877) 700-4477 ---- Toll Free

(818) 341-1500 (US & NON US calls)
 (818) 341-0015 (US & NON US calls)

Phone Ordering Only
 M-F 7:30am - 5:00pm PST
 Sat 9am - 2pm PST

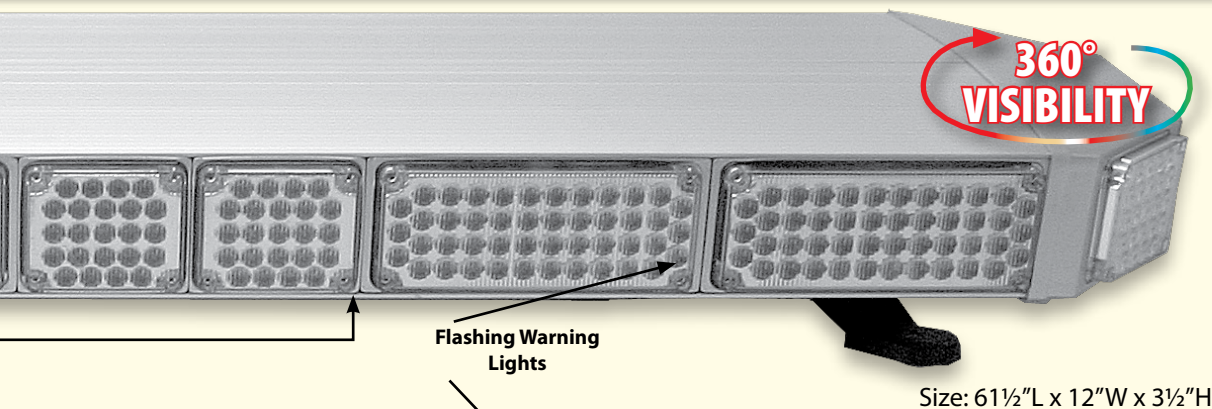

Size: 61½" L x 12" W x 3½" H



MSRP \$1299⁹⁹
PRICE REDUCTION NOW ONLY
\$499⁹⁹

Amber only
 Other colors available at \$49⁰⁰ extra

7 BUTTON CONTROL BOX



LED COLOR	60" Version ITEM #
	Amber LEDTOW-65
	Red LEDTOW-66
	Red/Blue LEDTOW-67
	Green LEDTOW-68
	Blue LEDTOW-69

22" OPTI-RANGE STEALTH MINI-LED LIGHTBAR

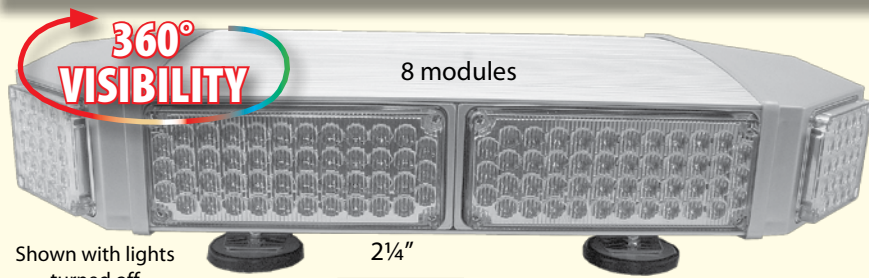

- 8 LED modules with automatic alternating flash pattern
- Light is clear when off for a stealthy look
- 2 halogen alley lights, each side with separate controls
- 12 foot cord with cigarette adapter (12V DC)
- Steadfast magnetic mount
- Includes 3 button control box
- Size: 22½" L x 12 ½" W x 3½" H



MSRP \$399⁹⁹
PRICE REDUCTION NOW ONLY
\$199⁹⁹

Amber only
 Other colors available at \$29⁰⁰ extra

3 BUTTON CONTROL BOX



LED COLOR	22" Version ITEM #
	Amber LED-55
	Red LED-56
	Red/Blue LED-57
	Green LED-58
	Blue LED-59

Replacement LED modules available in these colors: \$14⁹⁹ each LEM-03	Replacement lenses available <input type="checkbox"/> Clear \$4⁹⁹ each LEM-01 Please specify front or side when ordering
---	---

All prices subject to change. Any pictorial or typographical errors subject to correction when an order is placed.
 Proof of occupation is required for purchase of any law enforcement items.

UAW WILL MATCH COMPETITORS PUBLISHED PRICES

Lightbars are subject to oversize shipping cost



- Ideal for tow trucks, fire trucks and oversized vehicles
- 30 of the brightest LEDs on the market
- 12 selectable flash patterns
- Aerodynamic design with hard anodized finish
- 2 rear lights for instant workspace lighting

- Directional traffic system on the front and rear activates three warning patterns (left, right and center flashing)
- Includes 7 button control box and gutter style universal mounting kit
- Includes 12 foot power cord (hard wired only)
- Power: 12V DC

45" OPTI-RANGE STEALTH ULTRA LIGHTBARS

Size: 45½"L x 12"W x 4½"H

Lightbars are subject to oversize shipping cost

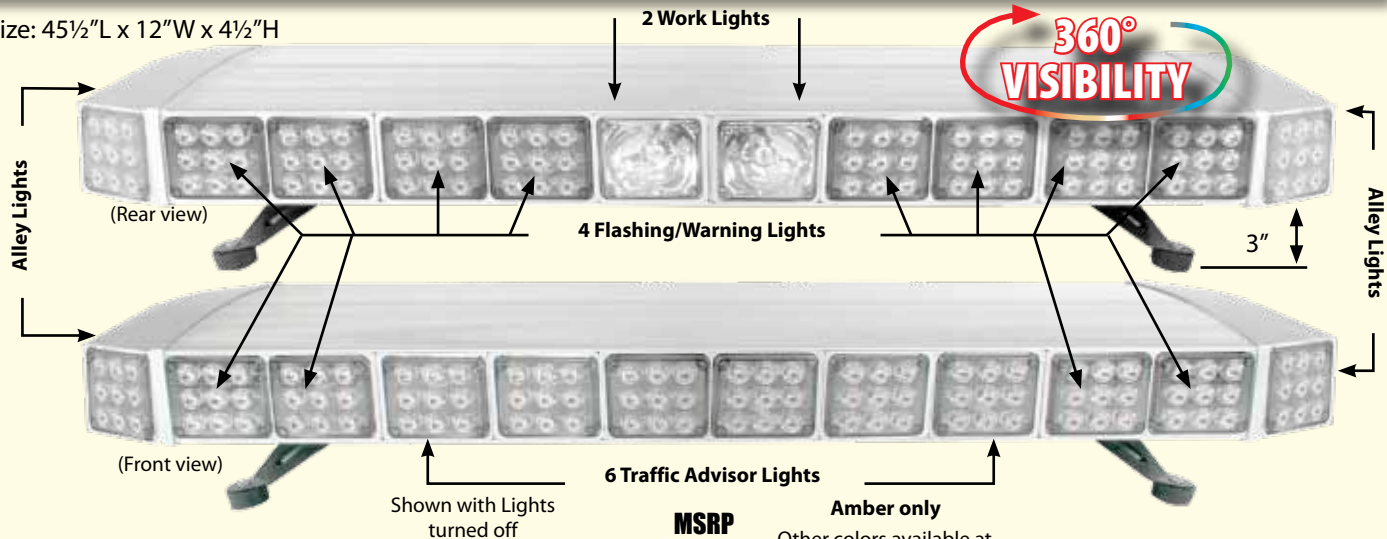

- 22 of the brightest LEDs on the market
- 12 selectable flash patterns
- Aerodynamic design with hard anodized finish
- 2 steady alley lights, 1 each side with separate controls
- Directional traffic system on rear only
- Includes 7 button control box, universal mounting kit and 12ft cord
- Power: 12V DC

MSRP \$2049⁹⁹
PRICE REDUCTION NOW ONLY
\$599⁹⁹

Amber only
 Other colors available at \$39.00 extra

LED COLOR	ITEM #
	Amber LED-165
	Blue LED-169
	Red LED-166
	Red/Blue LED-167

Replacement modules: LEM-05
 Indicate color when placing order.

Tel: (877) 643-1100 --- Toll Free
 Fax: (877) 700-4477 --- Toll Free

(818) 341-1500 (US & NON US calls)
 (818) 341-0015 (US & NON US calls)

Phone Ordering Only
 M-F 7:30am - 5:00pm PST
 Sat 9am - 2pm PST

Size: 62"L x 4½"H x 12"W

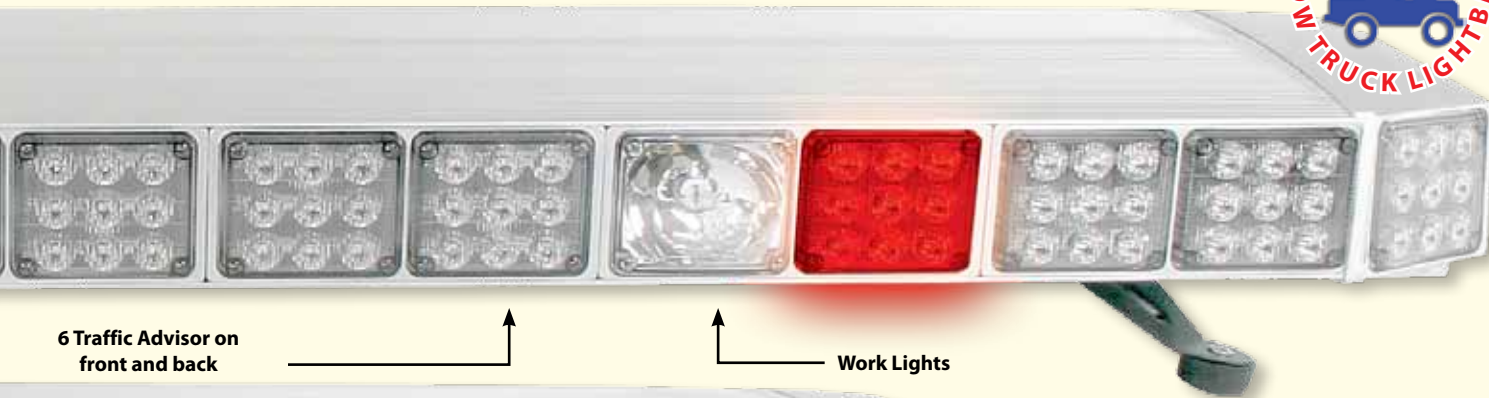

6 Traffic Advisor on front and back

Work Lights



3"

MSRP \$2940⁹⁹



Amber only
Other colors available at \$59⁰⁰ extra



7 BUTTON CONTROL BOX



LED COLOR	LENS COLOR	ITEM #
	Clear	LED-265
	Clear	LED-266
	Clear	LED-267
	Clear	LED-268

22" OPTI-RANGE STEALTH ULTRA MINI LED LIGHTBAR WITH TAKE DOWN LIGHTS

- 10 LED modules with automatic alternating flash pattern
- 2 front mounted halogen take down lights
- Light is clear when off for a stealthy look
- 1 halogen alley light on each side with separate controls
- 12 foot cord with cigarette adapter (12V DC)
- Steadfast magnetic mount
- Includes 3 button control box
- Size: 22½"L x 12½"W x 3½"H

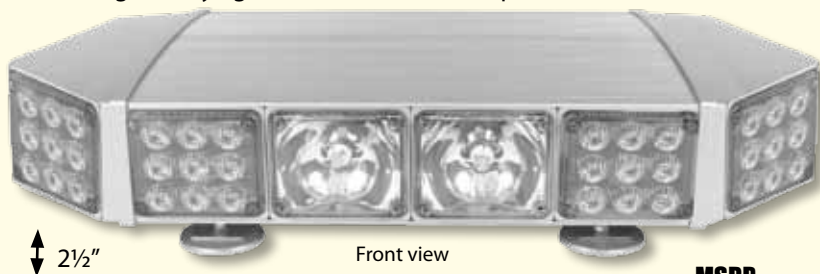

2½"

Front view

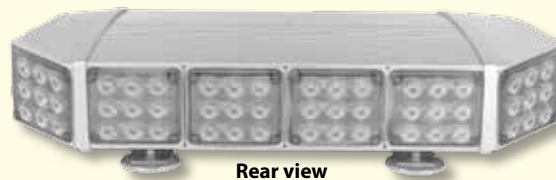

Rear view

Lights shown turned off

MSRP \$1389⁹⁹



Amber only
Other colors available at \$29⁰⁰ extra

Replacement LED lenses available in these colors:
A R B G C
\$29⁹⁹ each LEM-05
Specify front, corner or rear

Replacement halogen lenses available in these colors:
A R B G C
\$4⁹⁹ each LEN-05
Please specify color and front or corner when ordering

LED COLOR	LENS COLOR	ITEM #
	Clear	LED-150
	Clear	LED-151
	Clear	LED-152
	Clear	LED-153
	Clear	LED-154

Call for specific module replacements

All prices subject to change. Any pictorial or typographical errors subject to correction when an order is placed.

Proof of occupation is required for purchase of any law enforcement items.

UAW WILL MATCH COMPETITORS PUBLISHED PRICES

Lightbars are subject to oversize shipping cost

- 22 new 20% brighter modules with 4 LEDs in each front and back module and 3 LEDs in each end module
- Ultra slim profile with clear lens for a stealth look
- Choose from 12 popular flash patterns
- Built-in amber arrowstick lights on the back
- 2 LED take-down lights
- Includes universal gutter style mount kit and 7 button control box
- Ideal for fire trucks, tow trucks and oversized vehicles
- 12 foot power cord (12V DC) (hard wired only)
- 1.78"H x 12"W x 47"L

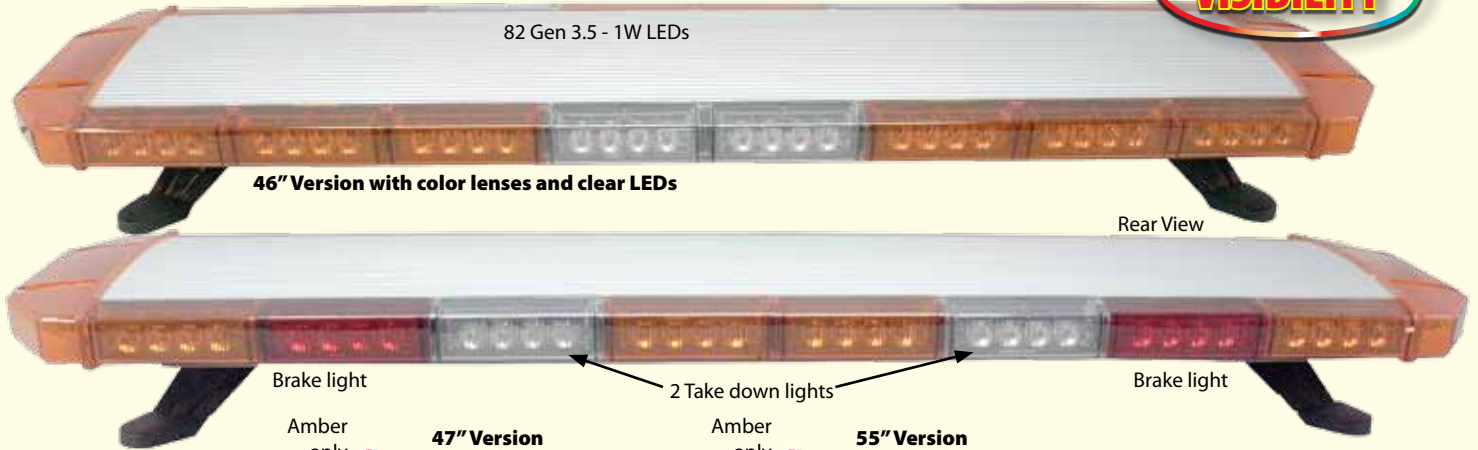

46" Version with color lenses and clear LEDs

Brake light

2 Take down lights

Rear View

Brake light

Amber only

47" Version

\$499⁹⁹

Other colors add \$49⁰⁰

Amber only

55" Version

\$699⁹⁹

Other colors add \$49⁰⁰



LENS COLOR	LED Color	ITEM #
Amber	Clear	LEDTOW-5000A
Red	Clear	LEDTOW-5000R
Blue	Clear	LEDTOW-5000B
Green	Clear	LEDTOW-5000G
Blue/Red	Clear	LEDTOW-5000RB

LENS COLOR	LED Color	ITEM #
Amber	Clear	LEDTOW-5605A
Red	Clear	LEDTOW-5605R
Blue	Clear	LEDTOW-5605B
Green	Clear	LEDTOW-5605G
Blue/Red	Clear	LEDTOW-5605RB



34 Gen 3.5 - 1W LEDs



27" Version

50 Gen 3.5 - 1W LEDs

27" Version

Amber only

\$299⁹⁹

Other colors add \$29⁰⁰

LENS COLOR	LED Color	ITEM #
Amber	Clear	LED-5050A
Red	Clear	LED-5050R
Blue	Clear	LED-5050B
Green	Clear	LED-5050G
Blue/Red	Clear	LED-5050RB



15" Version

15" Version

Amber only

\$229⁹⁹

Other colors add \$29⁰⁰

LENS COLOR	LED Color	ITEM #
Amber	Clear	LED-5015A
Red	Clear	LED-5015R
Blue	Clear	LED-5015B
Green	Clear	LED-5015G
Blue/Red	Clear	LED-5015RB

Lightbars are subject to oversize shipping cost



Call for other available color configurations and replacement parts



Tel: (877) 643-1100 ---- Toll Free
Fax: (877) 700-4477 ---- Toll Free

(818) 341-1500 (US & NON US calls)
(818) 341-0015 (US & NON US calls)

Phone Ordering Only
 M-F 7:30am - 5:00pm PST
 Sat 9am - 2pm PST

D LIGHTBARS



Front View LED-5605 55" version

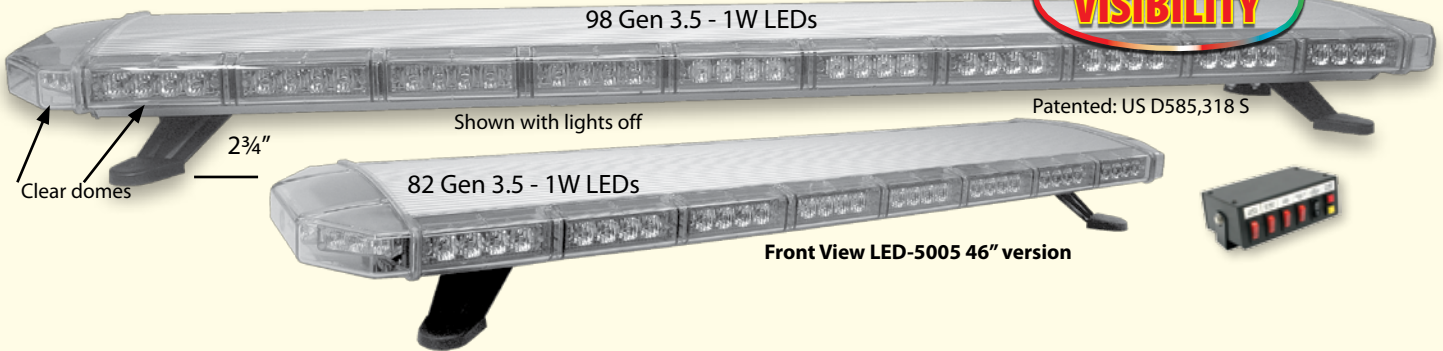

- New 20% brighter LED modules with 4 LEDs (front & Back)
- Ultra slim profile with clear lens for a stealth look
- Choose from 12 selectable flash patterns
- Built-in amber arrowstick lights on the back flashes left, center in or right

- 2 LED take-down lights and 2 LED alley lights
- Includes gutter mounting kit and 7 button control box
- Ideal for fire trucks, tow trucks and oversized vehicles
- 12 foot power cord (12V DC) (27" & 15" lights use a cigarette adaptor plug)

Amber only **\$699⁹⁹** 98 Gen 3.5 - 1W LEDs
Other colors add \$79⁰⁰

COLOR	ITEM #
Amber	LED-5605
Red	LED-5606
Red/Blue	LED-5607
Green	LED-5608
Blue	LED-5609

Amber only **\$499⁹⁹** 82 Gen 3.5 - 1W LEDs
Other colors add \$49⁰⁰

COLOR	ITEM #
Amber	LED-5005
Red	LED-5006
Red/Blue	LED-5007
Green	LED-5008
Blue	LED-5009

Amber only
Other colors add \$29⁰⁰

27" Version

COLOR	ITEM #
Amber	LED-5055
Red	LED-5056
Red/Blue	LED-5057
Green	LED-5058
Blue	LED-5059

2 smaller lights use a cigarette adaptor plug

Amber only
Other colors add \$29⁰⁰

15" Version

COLOR	ITEM #
Amber	LED-5025
Red	LED-5026
Red/Blue	LED-5027
Green	LED-5028
Blue	LED-5029

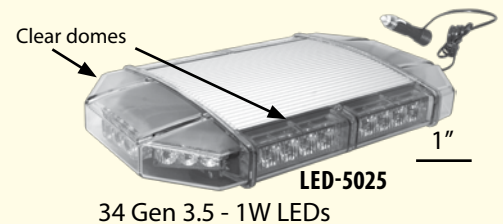

All prices subject to change. Any pictorial or typographical errors subject to correction when an order is placed.
Proof of occupation is required for purchase of any law enforcement items.

UAW WILL MATCH COMPETITORS PUBLISHED PRICES

Lightbars are subject to oversize shipping cost

INTERCHANGEABLE LED MODULES AND LENSES



COLOR LENS AND CLEAR LEDES 82 Gen 3.5 - 1W LEDs **CLEAR LENS AND COLOR LED**

LEM-12CA
Amber Lens & Clear LEDs

LEM-12CR
Red Lens & Clear LEDs

LEM-12CG
Green Lens & Clear LEDs

LEM-12CC
Clear Lens & Clear LEDs

LEM-12CB
Blue Lens & Clear LEDs

LEM-12AC
Amber LEDs & Clear Lens

LEM-12BC
Blue LEDs & Clear Lens

LEM-12GC
Green LEDs & Clear Lens

LEM-12RC
Red LEDs & Clear Lens

LEM-08
Clear LEDs & Clear Lens

Customize your own lightbar!

\$29⁹⁹ EACH

A SMALL CUSTOMIZATION FEE PER LIGHTBAR WILL APPLY

All modules are fully water resistant

\$19⁹⁹ EACH

BLACK STREAMLINED LINEAR GENERATION 3.5 LED LIGHTBARS

- 26 High intensity linear GEN 3.5 LED modules
- Ultra slim profile and clear lens for stealth look
- Choose from many flash patterns
- Built-in amber arrowstick and break lights on back



- Ideal for fire trucks, tow truck and oversized vehicles
- 2 LED take-down lights and 2 LED alley lights
- Includes gutter style mounting kit and 7 button control box
- 12 foot power cord (12V DC) (2 smaller lights use a cigarette adaptor plug)

360° VISIBILITY

26 modules - 156 Gen 3.5 LEDs

Each module has 6 Gen 3.5 LEDs

Amber arrowstick on back flashes left, center, right

Shown with lights turned off

US Patent No: D545, 230

Lightbars are subject to oversize shipping cost

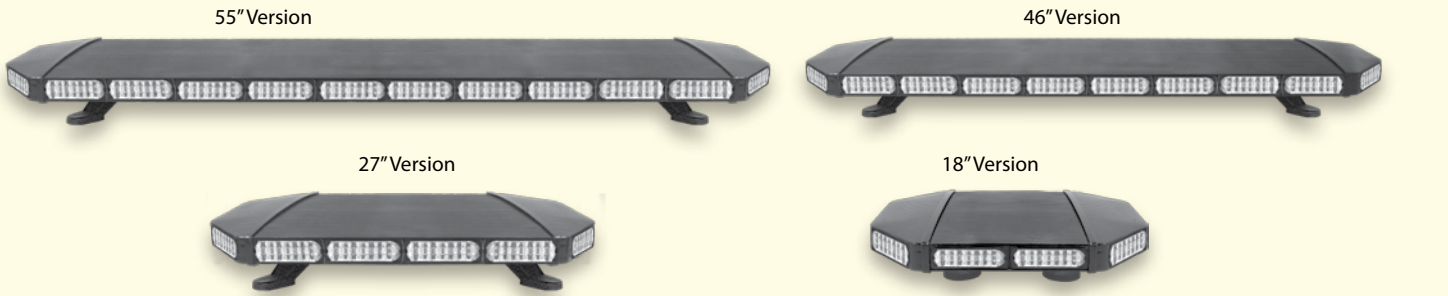

55" Version		46" Version		27" Version		18" Version	
COLOR	ITEM #	COLOR	ITEM #	COLOR	ITEM #	COLOR	ITEM #
Amber only	\$799⁹⁹	Amber only	\$599⁹⁹	Amber only	\$389⁹⁹	Amber only	\$279⁹⁹
26 modules 156 LEDs		22 modules 132 LEDs		14 modules 84 LEDs		10 modules 60 LEDs	
Amber	LED-6605	Amber	LED-6005	Amber	LED-6055	Amber	LED-6025
Red	LED-6606	Red	LED-6006	Red	LED-6056	Red	LED-6026
Red/Blue	LED-6607	Red/Blue	LED-6007	Red/Blue	LED-6057	Red/Blue	LED-6027
Green	LED-6608	Green	LED-6008	Green	LED-6058	Green	LED-6028
Blue	LED-6609	Blue	LED-6009	Blue	LED-6059	Blue	LED-6029
Other colors add \$79 ⁰⁰		Other colors add \$39 ⁰⁰		Other colors add \$29 ⁰⁰		Other colors add \$19 ⁰⁰	

Also available in a silver version. Please see our web site for full details

Tel: (877) 643-1100 --- Toll Free
Fax: (877) 700-4477 --- Toll Free

(818) 341-1500 (US & NON US calls)
(818) 341-0015 (US & NON US calls)

Phone Ordering Only
M-F 7:30am - 5:00pm PST
Sat 9am - 2pm PST

48" HUSKY HALOGEN ROTATING LIGHTBARS

- 5 halogen rotators with speed of 130 FPM
- 2 take-down lights and 2 alley lights
- Additional lower flashing lights on front and back for increased visibility
- Includes 5 button control box, 12 foot cord and gutter style mounting kit
- Size: 48"L x 12"W 7"H
- Power: 12V DC



MSRP
\$499⁹⁹
PRICE REDUCTION
NOW ONLY
\$199⁹⁹

Amber only
Other colors available at
\$39.⁰⁰ extra

INCLUDED HARDWARE

UNIVERSAL MOUNTING KIT

5 BUTTON CONTROL BOX



Replacement domes available in these colors:



\$19⁹⁹ each
DOM-02

Replacement large filters available in these colors:



\$9⁹⁹ each
LFL-01

Replacement end lenses available in these colors:

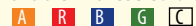

\$4⁹⁹ each
LEN-03

Please specify color when ordering

All prices subject to change. Any pictorial or typographical errors subject to correction when an order is placed.
Proof of occupation is required for purchase of any law enforcement items.

UAW WILL MATCH COMPETITORS PUBLISHED PRICES

Lightbars are subject to oversize shipping cost

Front View

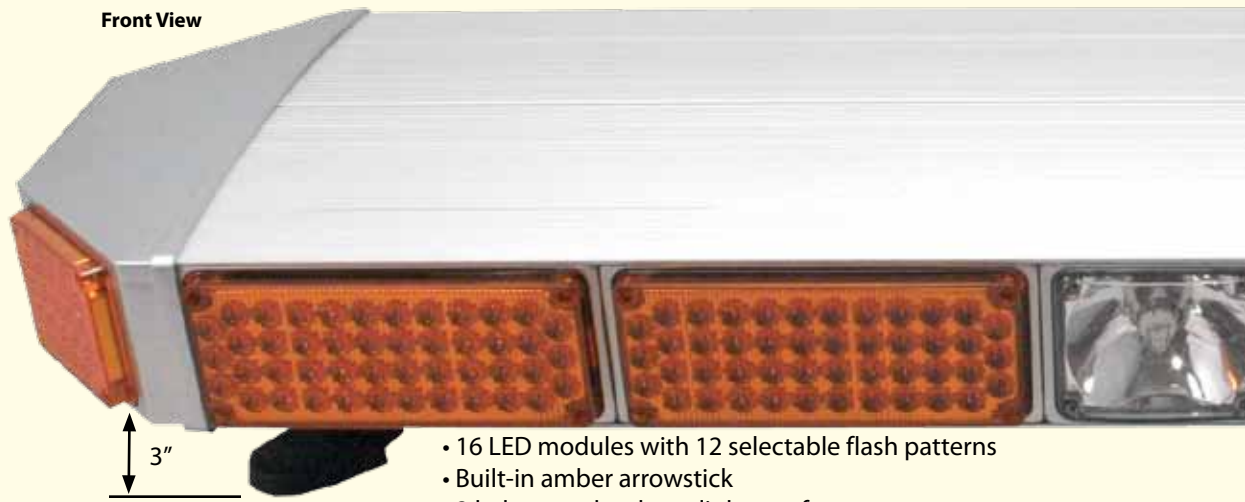

MSRP
\$899⁹⁹



Amber only

Other colors available at
\$39⁰⁰ extra

3"

- 16 LED modules with 12 selectable flash patterns
- Built-in amber arrowstick
- 2 halogen take-down lights on front
- 2 halogen alley lights on each side controlled independently
- 12 foot power cable



Rear View

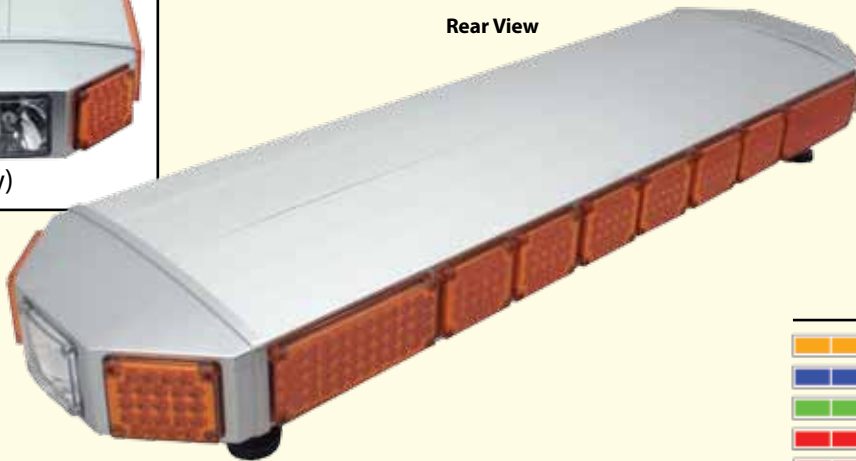

7 BUTTON CONTROL BOX



LENS COLOR	ITEM #
	Amber LED-60
	Blue LED-63
	Green LED-64
	Red LED-62
	Red/Blue LED-61

22" OPTI-RANGE LED LIGHTBAR

Lights turned off



- 8 LED modules with alternating flash pattern
- 2 halogen alley lights on each side with separate controls
- 12 foot cord with cigarette adapter
- Steadfast magnetic mount
- Includes 3 button control box
- Size: 22 1/2"L x 12 1/2"W x 3 1/2"H



LED-50

2 1/4"

MSRP
\$399⁹⁹



Amber only
Other colors available at
\$19⁰⁰ extra

3 BUTTON CONTROL BOX



Replacement lenses available in these colors:



Replacement LED modules available in these colors:

Clear
\$29⁹⁹ each LEM-03
Please specify front or side when ordering

LED COLOR ITEM #

	Amber LED-50
	Red LED-53
	Red/Blue LED-52
	Green LED-51
	Blue LED-54

Lightbars are subject to oversize shipping cost

Tel: (877) 643-1100 ---- Toll Free
Fax: (877) 700-4477 ---- Toll Free

(818) 341-1500 (US & NON US calls)
(818) 341-0015 (US & NON US calls)

Phone Ordering Only
M-F 7:30am - 5:00pm PST
Sat 9am - 2pm PST

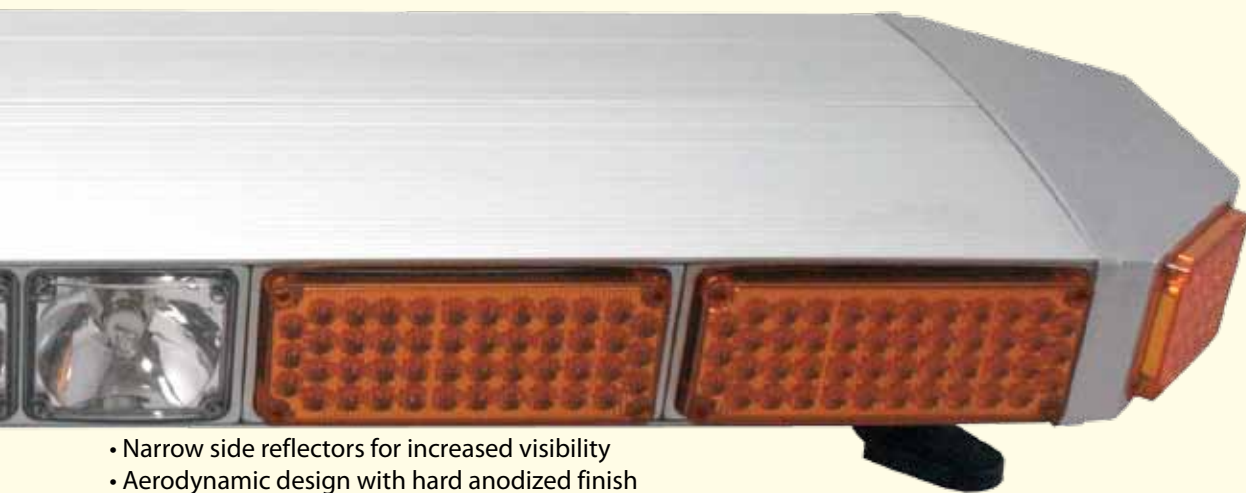

- Narrow side reflectors for increased visibility
- Aerodynamic design with hard anodized finish
- Includes gutter style mounting kit and 7 button control box
- Size: 45½"L x 12"W x 3½"H
- Power: 12V DC



46" OPTI-RANGE LED LIGHTBAR WITH SPEAKER & SIREN



2¾"

- 16 LED modules with 12 selectable flash patterns
- Built-in amber arrowstick
- Narrow side reflectors for increased visibility
- Front mounted 100 watt speaker
- Aerodynamic design with hard anodized finish
- Includes universal mounting kit, 7 button control box and 6 function siren
- 12 foot power cable
- Power: 12V DC
- Size: 45½"L x 3½"H x 12"W

MSRP \$999⁹⁹
PRICE REDUCTION NOW ONLY
\$499⁹⁹

Amber only
 Other colors available at \$39⁰⁰ extra

7 BUTTON CONTROL BOX



LENS COLOR ITEM #

	Amber	LED-160
	Blue	LED-161
	Green	LED-162
	Red	LED-163
	Red/Blue	LED-164



OPTI-RANGE SERIES REPLACEMENT PARTS

UNIVERSAL MOUNTING KIT

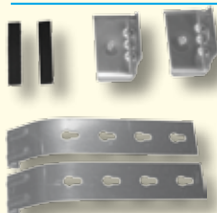

\$29⁹⁹/Set
 MOKIT

Replacement LED modules		Replacement lenses		
SQUARE & CORNER	RECTANGLE	SQUARE	RECTANGLE	CORNER
LEM-03 A	LEM-04 A	LEN-01 A	LEN-02 A	LEN-03 A
LEM-03 R	LEM-04 R	LEN-01 R	LEN-02 R	LEN-03 R
LEM-03 B	LEM-04 B	LEN-01 B	LEN-02 B	LEN-03 B
LEM-03 G	LEM-04 G	LEN-01 G	LEN-02 G	LEN-03 G
LEM-03 C	LEM-04 C	LEN-01 C	LEN-02 C	LEN-03 C

\$29⁹⁹ each

\$4⁹⁹ each

7 BUTTON CONTROL BOX



COB0-06
\$29⁹⁹ each

3 BUTTON CONTROL BOX



COB0-03
\$19⁹⁹ each

All prices subject to change. Any pictorial or typographical errors subject to correction when an order is placed.
 Proof of occupation is required for purchase of any law enforcement items.

UAW WILL MATCH COMPETITORS PUBLISHED PRICES

Lightbars are subject to oversize shipping cost

THE BRIGHTEST LIGHTS ON THE MARKET

46" OPTI-RANGE STROBE LIGHTBARS

Features strobe lights in the front, halogen traffic advisors on the rear and additional strobe lights on each side.

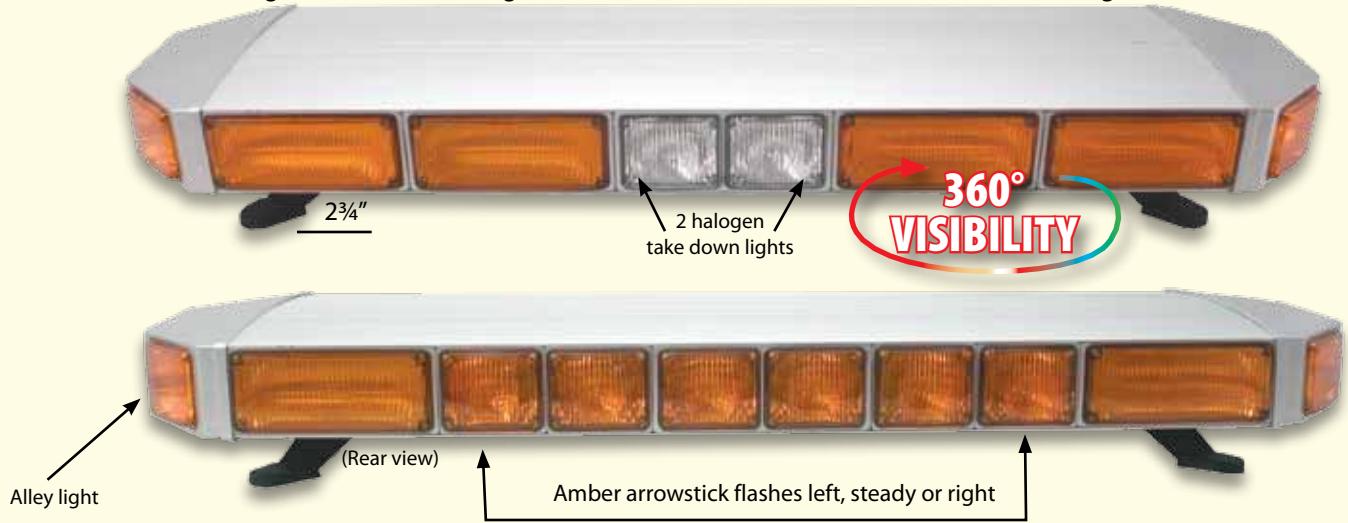

- Strobe light for maximum warning power
- 2 halogen take-down lights and 2 alley lights
- Halogen arrowstick in the back
- Aerodynamic design with anodized finish
- Includes 6 button control box, 12 foot cord and universal mounting kit
- Size: 45 1/2" L x 12" W x 30 1/2" H
- Rapid quad flash pattern
- Power: 12V DC

MSRP
\$1209⁹⁹
PRICE REDUCTION NOW ONLY
\$399⁹⁹

Amber only
Other colors available at
\$39.00 extra

6 BUTTON CONTROL BOX



LENS COLOR	ITEM #
	Amber LBS-90
	Blue LBS-94
	Green LBS-96
	Red LBS-92
	Red/Blue LBS-91

Replacement lenses available in these colors:

\$4⁹⁹ each LEM-04
 Specify front, corner or rear

22" OPTI-RANGE MINI STROBE LIGHTBARS

- Strobe lights in the front, rear and sides for maximum warning power
- Rapid quad flash pattern
- 12 foot cord with cigarette adapter
- Steadfast magnetic mount
- 2 halogen alley lights on each controlled independently
- Includes 3 button control box
- Size: 22 1/2" L x 12 1/2" W x 3 1/2" H
- Power: 12V DC

MSRP
\$499⁹⁹
PRICE REDUCTION NOW ONLY
\$199⁹⁹

Amber only
Other colors available at
\$29.00 extra



LENS COLOR	ITEM #
	Amber LBS-50
	Blue LBS-55
	Green LBS-53
	Red LBS-56
	Red/Blue LBS-54

INCLUDED HARDWARE



Replacement strobe modules available:
\$29⁹⁹ each STM-01
 Replacement lenses available in these colors

\$4⁹⁹ each LEM-04
 Please specify color and front, corner or side when ordering

Lightbars are subject to oversize shipping cost

Tel: (877) 643-1100 --- Toll Free
Fax: (877) 700-4477 --- Toll Free

(818) 341-1500 (US & NON US calls)
(818) 341-0015 (US & NON US calls)

Phone Ordering Only
 M-F 7:30am - 5:00pm PST
 Sat 9am - 2pm PST

OPTI-RANGE HALOGEN LIGHTBAR

These lightbars feature halogen lights in the front, complimented by halogen arrowstick on the back with additional halogen lights on each side

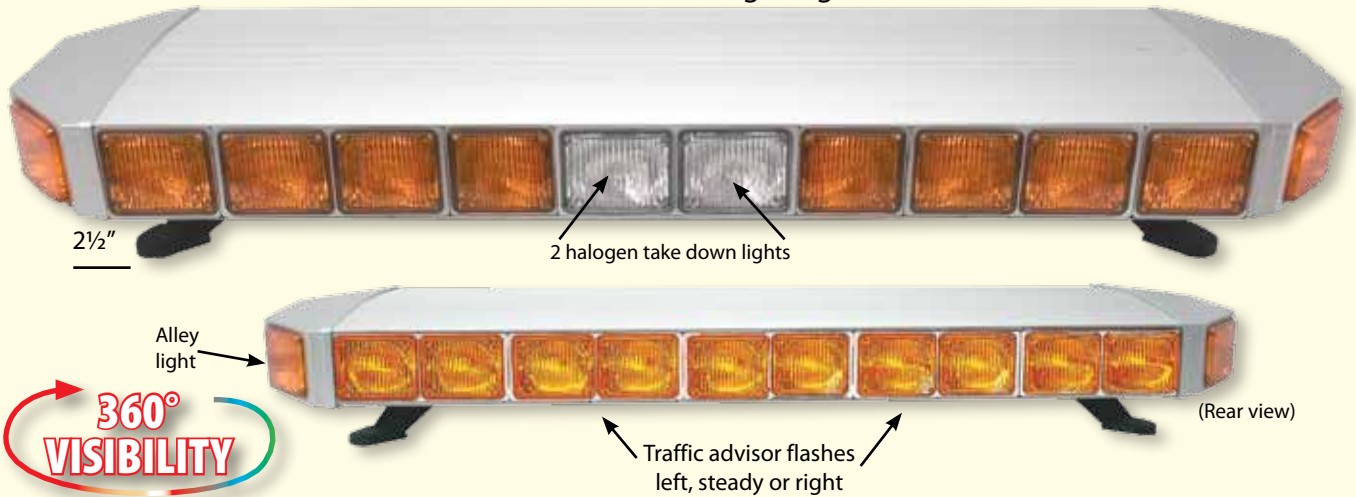

- Automatic alternating flash pattern
- 2 halogen take-down lights and 2 alley lights
- Traffic advisor in the back
- Built-in amber arrowstick
- Power: 12V DC

- Aerodynamic design with anodized finish
- Includes 6 button control box, 12 foot cord and universal mounting kit
- Size: 45½" L x 12" W x 3½" H

LENS COLOR	ITEM #
	Amber LBH-60
	Red LBH-62
	Red/Blue LBH-64
	Green LBH-66
	Blue LBH-63

Replacement lenses available in these colors:
A R B G
 \$4⁹⁹ each
 LEN-05
 Please specify color and front or corner when ordering

MSRP \$469⁹⁹
PRICE REDUCTION NOW ONLY
\$299⁹⁹
 Amber only
 Other colors available at \$39.⁰⁰ extra

22" OPTI-RANGE MINI HALOGEN LIGHTBARS

- Rapidly alternating halogen flashers in the front and rear for maximum visibility
- 12 foot cord with cigarette lighter adapter
- Steadfast magnetic mount

- 2 alley lights on each side controlled independently
- Includes 3 button control box
- Size: 22½" L x 12½" W x 3½" H
- Power: 12V DC



MSRP \$299⁹⁹
PRICE REDUCTION NOW ONLY
\$169⁹⁹

Amber only
 Other colors available at \$29.⁰⁰ extra

Replacement lenses available in these colors
A R B G
 \$4⁹⁹ each LEN-02
 Please specify color and front, corner or side when ordering

INCLUDED HARDWARE



Lightbars are subject to oversize shipping cost

All prices subject to change. Any pictorial or typographical errors subject to correction when an order is placed.
 Proof of occupation is required for purchase of any law enforcement items.

UAW WILL MATCH COMPETITORS PUBLISHED PRICES

48" HUSKY HALOGEN ROTATING LIGHTBARS WITH SPEAKER COMPARTMENT

- 4 halogen rotators with speed of 130 FPM
- 2 alley lights and additional lower flashing lights on front and back for increased visibility
- Speaker compartment
- Includes 4 button control box, 12 foot cord and universal mounting kit
- Size: 48"L x 12"W 7"H



MSRP
\$499⁹⁹
PRICE REDUCTION NOW ONLY
\$199⁹⁹

Amber only
Other colors available at
\$39⁰⁰ extra

INCLUDED HARDWARE

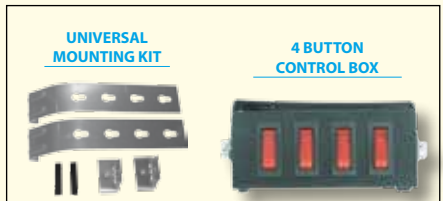

<p>Replacement domes available in these colors:</p> <p>A R B G C</p> <p>\$19⁹⁹ each DOM-02</p>	<p>Replacement large filters available in these colors:</p> <p>A R B G C</p> <p>\$9⁹⁹ each LFL-01</p> <p>Please specify color when ordering</p>	<p>Replacement end lenses available in these colors:</p> <p>A R B G C</p> <p>\$4⁹⁹ each LEN-03</p>
--	---	--

8 HEAD HALOGEN ARROW STICK



- Eight halogen lamps drawing a total of 80 W at 6.4A
- Includes universal mounting kit
- 2 button control box (On/Off, Right, Left, Warning Flash)
- 12 foot long power cord
- For internal or external use
- Size: 32 3/4" L x 3 3/4" W x 2 3/8" H



\$99⁹⁵
LBH-200
Amber Only

Lightbars are subject to oversize shipping cost

44" HALOGEN ROTATING LIGHTBARS WITH SPEAKER COMPARTMENT

- 4 halogen rotators
- 2 alley lights, each controlled independently
- Includes 5 button control box, 12 foot power cord (hard wired only) and gutter style mounting kit

- Speaker compartment for compact speaker (not included)
- Size: 44"L x 6"H 12"W
- Power: 12V DC

MSRP \$499⁹⁹
PRICE REDUCTION NOW ONLY
\$179⁹⁹

Amber only
 Other colors available at \$39.00 extra

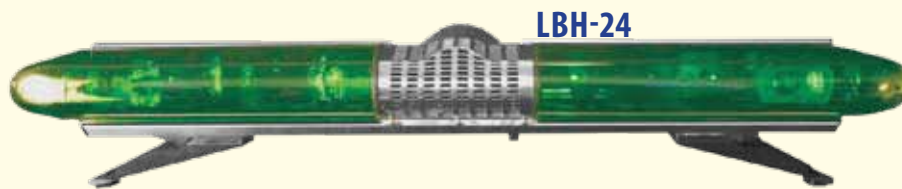

INCLUDED HARDWARE

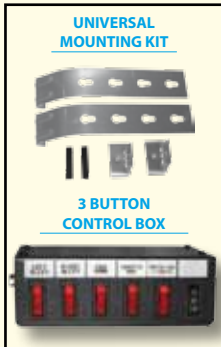

Replacement domes available in these colors:

A R B G C
\$19⁹⁹ each
 DOM-04

Replacement filters available in these colors:

A R B G C
\$9⁹⁹ each
 LFL-01

Please specify color when ordering

24" MINI HALOGEN ROTATING LIGHTBARS

MSRP \$149⁹⁹
Amber only
 Other colors available at \$19.00 extra

PRICE REDUCTION NOW ONLY
\$69⁹⁹

- 2 halogen rotators with speed of 130 RPM
- Steadfast magnetic mount
- Includes a 9 ft cord with cigarette plug
- Size: 24"L x 12"W 5"H
- One touch switch
- Power: 12V DC



Replacement domes available in these colors:

A R B G C
\$14⁹⁹ each
 DOM-05

Replacement filters available in these colors:

A R B G C
\$9⁹⁹ each
 LFL-02

Please specify color when ordering

All prices subject to change. Any pictorial or typographical errors subject to correction when an order is placed. Proof of occupation is required for purchase of any law enforcement items.

UAW WILL MATCH COMPETITORS PUBLISHED PRICES

Lightbars are subject to oversize shipping cost

134 LIGHT BARS

24" MINI HALOGEN ROTATING LIGHTBARS

- Ideal for small vehicles • Size: 24"L x 12"W x 6½"H
- 2 halogen rotators with speed of 130 RPM
- Diamond shape mirrors for higher visibility
- 10,000 CP • Steadfast Magnetic Mount ©
- Includes a 9 ft coiled 12V DC cord cigarette plug featuring an protective fuse adaptor with one touch switch
- Power: 12V DC



\$69⁹⁹
Amber only
Other colors add \$19⁰⁰

LBH-05AA AMBER BOTH ENDS

LBH-05BB BLUE BOTH ENDS

LBH-05RR RED BOTH ENDS

LBH-05GG GREEN BOTH ENDS

LBH-05RB RED & BLUE **LBH-05AA** AMBER BOTH ENDS

LBH-05GA GREEN & AMBER

LBH-05RW RED & WHITE



MINI GENERATION 3.5 LED LIGHTBARS



- 6 LED modules with automatic alternating flash pattern
- Cigarette adapter (12V DC) • Steadfast magnetic mount
- Includes 2 button control box • Size: 11¾"L x 7"W x 2¾"H

Call for other available colors and replacement parts

\$139⁹⁹

Other colors add \$19⁰⁰



LED-13A AMBER **LED-13B BLUE** **LED-13R RED**
LED-13G GREEN **LED-13C CLEAR**

Lightbars are subject to oversize shipping cost

2 GENERATION 3 LED BEACON LIGHTS

- Generation 3 LEDs • Built in 12V cigarette power adaptor
- 100,000 hour life span • Double flash pattern of 120 FPM • UV stabilized lenses resist fading
- Includes colored lens with a clear outer protective lens 10 feet of cable • Includes magnetic mount

Red  **LED-140R** Green  **LED-140G** Blue  **LED-140B**

Amber  **LED-140A** Red Blue  **LED-140RB**

\$39⁹⁹
Each

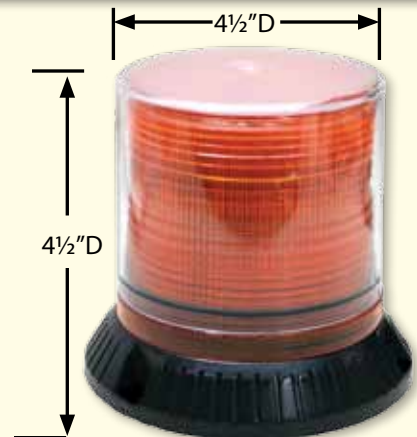

Tel: (877) 643-1100 ---- Toll Free
Fax: (877) 700-4477 ---- Toll Free

(818) 341-1500 (US & NON US calls)
(818) 341-0015 (US & NON US calls)

Phone Ordering Only
M-F 7:30am - 5:00pm PST
Sat 9am - 2pm PST

STREAMLINED ULTRA SLIM GEN 3.5 LED LIGHTBARS

- All High intensity Gen 3.5 LED modules
- Ultra slim profile and clear lens for stealth look
- Choose from many flash patterns
- Built-in amber arrowstick and brake lights on back
- Ideal for fire trucks, tow truck and oversized vehicles
- 2 LED take-down lights and 2 LED alley lights
- Includes gutter style mounting kit and control box
- 12 foot power cord (12V DC) (27" & 18" lights use a cigarette adaptor plug)

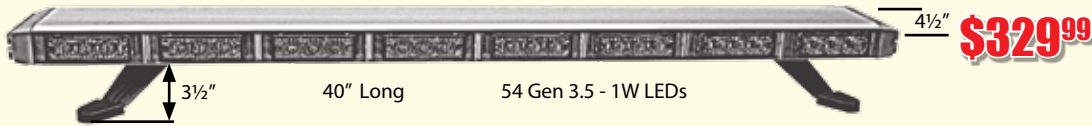
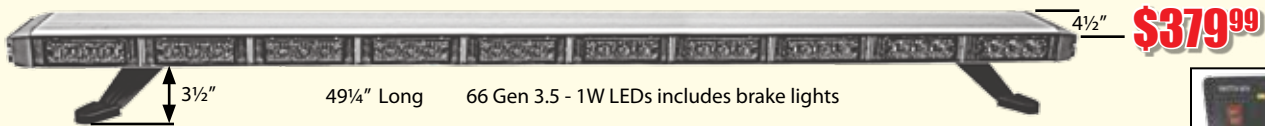
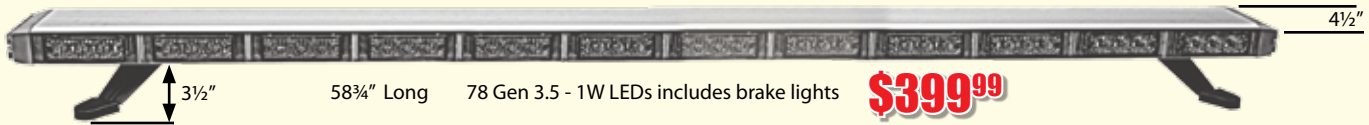

Version	Amber only	Item #	Version	Amber only	Item #	Version	Amber only	Item #	Version	Amber only	Item #
58 3/4" Version	Amber only	LED-7012A	49 1/4" Version	Amber only	LED-7010A	40" Version	Amber only	LED-7008A	30 1/2" Version	Amber only	LED-7006A
Red	Red	LED-7012R	Red	Red	LED-7010R	Red	Red	LED-7008R	Red	Red	LED-7006R
Red/Blue	Red/Blue	LED-7012RB	Red/Blue	Red/Blue	LED-7010RB	Red/Blue	Red/Blue	LED-7008RB	Red/Blue	Red/Blue	LED-7006RB
Green	Green	LED-7012G	Green	Green	LED-7010G	Green	Green	LED-7008G	Green	Green	LED-7006G
Blue	Blue	LED-7012B	Blue	Blue	LED-7010B	Blue	Blue	LED-7008B	Blue	Blue	LED-7006B
Other than amber add \$69. ⁰⁰			Other than amber add \$39. ⁰⁰			Other than amber add \$29. ⁰⁰			Other than amber add \$25. ⁰⁰		

21 1/4" Version **\$199⁹⁹** (Amber only)

COLOR	ITEM #
Amber	LED-4004A
Red	LED-4004R
Red/Blue	LED-4004RB
Green	LED-4004G
Blue	LED-4004B

Other than amber add \$19.⁰⁰

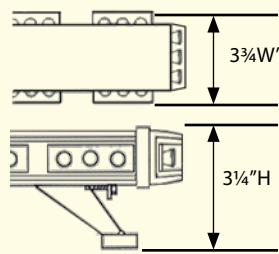

VISOR STYLE GEN 3.5 LED LIGHTBARS

- 8 head undercover GEN 3.5 LEDs interior split lightbar
- Uses an included visor bracket

24 Gen 3.5 - 1W LEDs

Amber	LED-15A
Red	LED-15R
Red/Blue	LED-15RB
Green	LED-15G
Blue	LED-15B

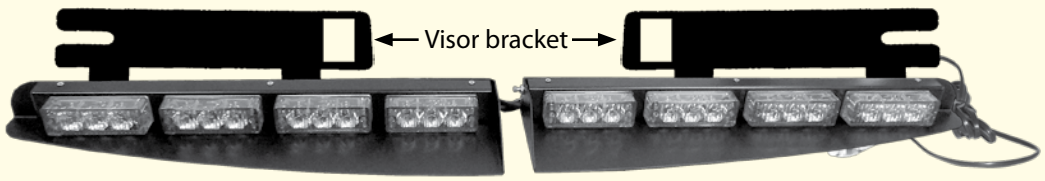

\$279⁹⁹

Call for other customizeable colors

Other than amber add \$25.⁰⁰

All prices subject to change. Any pictorial or typographical errors subject to correction when an order is placed. Proof of occupation is required for purchase of any law enforcement items.

UAW WILL MATCH COMPETITORS PUBLISHED PRICES

Lightbars are subject to oversize shipping cost

STREAMLINED CUSTOMIZABLE SLIM ARROWSTICKS

- High intensity LED modules • Slim profile for an aerodynamic look • Includes universal mounting kit
- 5 button control box (On/Off, Flashing, Right direction, Left direction and pattern selector) • 12 foot long power cord
- Mounts adjustable to span different heights • For internal or external use • Power: 12V DC • Each module is available in Amber, Blue, Green, Red and White upon requests



All lights shown off



8 LED Modules Size: 38"L x 3¼"W x 1¾"H

\$249⁹⁹

LED-210-B Black



7 LED Modules Size: 33¼"L x 3¼"W x 1¾"H

\$219⁹⁹

LED-250-B Black



6 LED Modules Size: 28½"L x 3¼"W x 1¾"H

\$199⁹⁹

LED-220-B Black



5 LED Modules
Size: 20½"L x 3¼"W x 1¾"H

\$169⁹⁹

LED-260-B Black



4 LED Modules
Size: 19"L x 3¼"W x 1¾"H

\$139⁹⁹

LED-230-B Black



3 LED Modules
Size: 13"L x 3¼"W x 1¾"H

\$119⁹⁹

LED-240-B Black

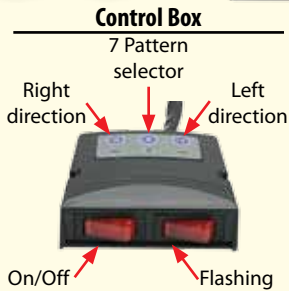

UNITS WITH 3, 4 or 5 MODULES ARE FLASHERS ONLY

- Ultra slim profile • 7 selectable flash patterns
- 1 button pattern selection switch • Universal mounting kit
- Internal and external use • Each module is available in Amber, Blue, Green, Red or White upon request

Replacement LED modules available in these colors:

A R B G C \$29.00 each LEM-01
Please specify color when ordering



47" STREAMLINED ULTRA ARROWSTICK



Amber only
Other colors available at \$29.00 extra

LED COLOR	LENS COLOR	ITEM #
Amber	Clear	LED-205
Red	Clear	LED-206
Red/Blue	Clear	LED-207



- High intensity LED modules
- Durable, rugged construction
- End warning LED modules
- Includes standard L style mount bracket
- Six array LED modules with 3 automatic flash patterns: left, right and warning-flash
- 3 button control box
- 12 foot cord with in line fuse connects directly to the battery
- Size: 47"L x 2"W x 1¾"H
- For vehicle interior use only
- Power: 12V DC

Replacement LED modules available in these colors: \$29.00 each
FCLEM-06 A FCLEM-06 R FCLEM-06 B FCLEM-06 G



Tel: (877) 643-1100 ---- Toll Free
Fax: (877) 700-4477 ---- Toll Free

(818) 341-1500 (US & NON US calls)
(818) 341-0015 (US & NON US calls)

Phone Ordering Only
M-F 7:30am - 5:00pm PST
Sat 9am - 2pm PST

VANGUARD DASH & DECK LIGHTS



Red/Blue Shown

\$49⁹⁹

Amber only
Other colors add \$9⁰⁰

- AMBER: LED-4001A**
- RED: LED-4001R**
- BLUE: LED-4001B**
- GREEN: LED-4001G**
- RED/BLUE: LED-4001RB**



\$69⁹⁹

Amber only
Other colors add \$9⁰⁰

- AMBER: LED-4002A**
- BLUE: LED-4002B**
- GREEN: LED-4002G**
- RED: LED-4002R**
- RED & BLUE: LED-4002RB**
- AMBER & GREEN: LED-4002AG**



Call about Customizing using many other colors!

SIREN SPEAKER & SIREN MEGAPHONE

- Six-tone siren (air-horn, wail, etc..) and megaphone
- Public address option
- Available in 80W & 100W

1 3/4"H x 5 1/8"W x 6"D



Switches operate optional lighting units

80 Watt:

- LB-35 Speaker:\$59.99**
- LB-36 Siren:\$59.99**
- LB-37 Siren Speaker Set:\$99.99**

- Black ABS plastic and metal construction
- Allows mounting behind the grille or in bumper
- Available in 80W & 100W

Siren size:
4 1/2"H x 7 1/4"W x 6 1/2"D

- 100 Watt:**
- LB-135 Speaker:\$69.99**
- LB-136 Siren:\$69.99**
- LB-137 Siren Speaker Set:\$119.99**

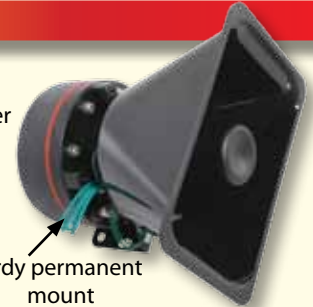

Sturdy permanent mount

- Control siren functions easily with the and held microphone
- 100W or 200W output
- Seven siren tone (air-horn, wail, etc.)
- Remote on/off switch box with built-in PA volume control
- 2.25"H x 4.8"W x 7.5"D
- Eleven rubberized push buttons with back light

COMPACT 100 WATT SPEAKER



- 100 Watts
- Non-corrosive finish
- Compact size: 6"H x 6"W x 3"D
- Includes bracket

\$79⁹⁹
S-100



- 100 Watt:**
- LB-135 Speaker \$79.99**
- LB-138 Siren \$79.99**
- LB-139 Siren Speaker Set \$129.99**



LB-237 Set shown
5 1/8"W x 1 3/4"H x 6"D

- 200 Watt:**
- LB-235 Speaker:\$99.99**
- LB-236 Siren:\$99.99**
- LB-237 Siren Speaker Set:\$179.99**

SPACE-SAVING 80W SPEAKER



- Less than 2" deep!
- Corrosion-resistant black finish
- 80W of power
- Weight: 4 lbs
- Includes a universal bracket that fits most vehicles
- 3 3/8"H x 4 1/2"W x 1 7/8"D

\$59⁹⁹ **S-102**

SPACE-SAVING 100W SPEAKER



- Only 2" deep!
- Corrosion-resistant metal finish
- 100W of power
- Weight: 5 lbs
- Includes a universal bracket that fits most vehicles
- Size: 4 1/2"H x 5 5/8"W x 2"D

\$69⁹⁹ **S-101**

All prices subject to change. Any pictorial or typographical errors subject to correction when an order is placed. Proof of occupation is required for purchase of any law enforcement items.

UAW WILL MATCH COMPETITORS PUBLISHED PRICES

LINEAR DASH & DECK LIGHTS

Single Module Unit

\$59⁹⁹

Amber only
Other colors add \$9⁰⁰

- AMBER: LED-6001A
- RED: LED-6001R
- BLUE: LED-6001B
- GREEN: LED-6001G



Both shown with
lights off

\$89⁹⁹

Double Module Unit

Amber only
Other colors add \$9⁰⁰



- AMBER: LED-6002A
- GREEN: LED-6002G
- RED: LED-6002R

- BLUE: LED-6002B
- RED & BLUE: LED-6002RB
- AMBER & GREEN: LED-6002AG



SURFACE MOUNT ULTRA LED LIGHT

- High intensity LEDs • Durable housing protects against moisture and vibration
- 15 selectable flash patterns
- Easy to mount anywhere • Fits on grilles



- AMBER: LED-2105
- RED: LED-2106
- WHITE: LED-2100W
- A/G: LED-2100AG
- GREEN: LED-2108
- BLUE: LED-2109
- R/W: LED-2100RW
- A/W: LED-2100AW
- RED/BLUE: LED-2107

\$39⁹⁹

LED WORKING LIGHT

- 5 intense 3 watt LEDs
- Moisture and vibration resistant
- Surface mounted
- LEDs provide unmatched high intensity warning, low current consumption.
- Updated design allows for faster and easier installation
- Swivel mount
- Size: 4 1/4" x 4 1/4" x 1 1/2"D

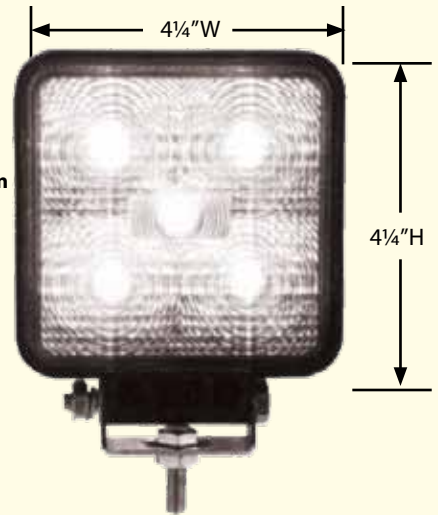

49⁹⁹ Each

WL-20

VANGUARD 3000 LED ATTACHMENT LIGHTS

- New GEN 3 LEDs provide excellent warning power
- 15 Selectable flash patterns
- Durable housing protects against vibration and moisture
- Includes 6 foot power cord
- Mounting kit adjust up and down and tilts



\$69⁹⁹

- AMBER: LED-01A
- RED: LED-01R
- GREEN: LED-01G
- BLUE: LED-01B
- Amber/Green: LED-01AG
- Amber/White: LED-01AW
- RED/BLUE: LED-01RB



\$59⁹⁹

- AMBER: LED-02A
- RED: LED-02R
- GREEN: LED-02G
- BLUE: LED-02B
- RED/BLUE: LED-02RB
- Amber/Green: LED-02AG
- Amber/White: LED-02AW

Tel: (877) 643-1100 ---- Toll Free
Fax: (877) 700-4477 ---- Toll Free

(818) 341-1500 (US & NON US calls)
(818) 341-0015 (US & NON US calls)

Phone Ordering Only
M-F 7:30am - 5:00pm PST
Sat 9am - 2pm PST

FLASHING TEARDROP BEACONS

This incandescent light is perfect for command or volunteer vehicles. Also great for golf carts.

Specifications:

- 130 rotations per minute for maximum visibility
- Magnetic attachment
- 11 foot cord plugs right into cigarette lighter
- 7" L x 5" W x 6" H
- 20 Watt Bulb
- One touch switch

MSRP \$39⁹⁹



Amber only
Other colors available at \$5⁰⁰ extra



SINGLE FLASHING STROBE BEACONS

- Strobe lights flash 80 times per minute
 - Sturdy magnetic mount
 - Dimensions: 3 1/2" x 4 1/2"
 - 12-foot cord plugs into cigarette lighter
 - Protective adaptor fuse built-in
- Applications: Fire Trucks, Police Automobiles, Ambulances, Security Vehicles, Peace Officer Vehicles, etc...



Amber only Other colors available at \$9⁰⁰ extra



DOUBLE FLASHING STROBE BEACONS

- Strobe lights flash 80 times per minute
- Sturdy magnetic mount
- Dimensions: 6 3/4" W
- 12-foot cord conveniently plugs into cigarette lighter
- Protective adaptor fuse built-in
- Multi-flash for maximum visibility



MSRP \$85⁹⁹

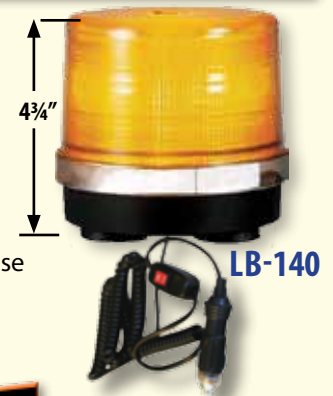

TWIN BEAM ROTATING BEACON

- 360° rotating beacon offers high visibility
- Sturdy magnetic mount
- 12 foot cord plugs into cigarette lighter
- Features an in line fuse to protect your vehicle
- 130 RPM
- One touch switch
- Dimensions 9" x 6 1/2"



Amber only
Other colors available at \$9⁰⁰ extra



All prices subject to change. Any pictorial or typographical errors subject to correction when an order is placed.
Proof of occupation is required for purchase of any law enforcement items.

UAW WILL MATCH COMPETITORS PUBLISHED PRICES

140 LIGHT BARS

TRICOLOR HOODIE & REFLECTIVE STRIPES

- 100% spun polyester microfiber fleece • Reflective material with silver fabric reflective stripes • 2 front pouch pockets • Elastic waist and cuffs • Thermal lined hood with drawstring • Zip closures



\$28⁹⁹

JS-106-GSH GREEN WITH SHERIFF ID

JS-107-O SH ORANGE WITH SHERIFF ID

\$28⁹⁹

JS-106-GP GREEN POLICE ID

JS-107-OP ORANGE POLICE ID

\$19⁹⁹

**JS-106 PLAIN GREEN NO ID
JS-107 PLAIN ORANGE NO ID**

\$28⁹⁹

**JS-106S GREEN WITH SECURITY ID
JS-107S ORANGE WITH SECURITY ID**

All IDs are patches added to the back and front left side

Call about adding your own company name or other patch to this jacket.

6 LED SURFACE MOUNT LIGHTS



RED: LED-03R

1 1/4" Deep

- High intensity LEDs • Each bulb is 1W • Durable housing protects against vibration and moisture • 15 selectable flash patterns • Easy mount bracket included

\$69⁹⁹

Each



AMBER: LED-03A



GREEN: LED-03G



BLUE: LED-03B



**AMBER/GREEN
LED-03AG**



**AMBER/WHITE
LED-03AW**

Tel: (877) 643-1100 ---- Toll Free
Fax: (877) 700-4477 ---- Toll Free

(818) 341-1500 (US & NON US calls)
(818) 341-0015 (US & NON US calls)

Phone Ordering Only
M-F 7:30am - 5:00pm PST
Sat 9am - 2pm PST

ADVANCED HIDEAWAY GENERATION 3 LED LIGHTS



OMNI HIDEAWAY LED HEADS

4 BULB LED SET

\$169⁹⁹

Clear only
Add \$5.00 for other colors

NEW

6 BULB LED SET

\$199⁹⁹

Clear only
Add \$5.00 for other colors

2 different sets available in these colors

LED-04C 4 LED Set Clear	LED-04R 4 LED Set Red	LED-04B 4 LED Set Blue	LED-04G 4 LED Set Green	LED-04A 4 LED Set Amber
LED-06C 6 LED Set Clear	LED-06R 6 LED Set Red	LED-06B 6 LED Set Blue	LED-06G 6 LED Set Green	LED-06A 6 LED Set Amber

60 Watt 4 LED set includes:

- 1 - connection box
- 1 - 6 foot power cord with
 - 1 - On/Off switch
 - 1 - button flash pattern selector with 4 selectable patterns
- 4 - LED heads
- 2 - 10 foot extension cables
- 2 - 15 foot extension cables
- Working voltage: 12V DC

90 Watt 6 LED set includes:

- 1 - connection box
- 1 - 6 foot power cord with
 - 1 - On/Off switch
 - 1 - button flash pattern selector with 4 selectable patterns
- 6 - LED heads
- 3 - 10 foot extension cables
- 3 - 15 foot extension cables
- Working voltage: 12V DC

15 Watt Clear LED Replacements

LED-11A Amber bulb only
LED-11B Blue bulb only
LED-11C Clear bulb only
LED-11G Green bulb only
LED-11R Red bulb only

\$29⁹⁹

ADVANCED HIDEAWAY GENERATION 3 LED LIGHTS



OMNI HIDEAWAY LED HEADS

4 BULB LED SET

\$149⁹⁹

Clear only
Add \$5.00 for other colors

NEW

6 BULB LED SET

\$189⁹⁹

Clear only
Add \$5.00 for other colors

2 different sets available in these colors

LED-104C 4 LED Set Clear	LED-104R 4 LED Set Red	LED-104B 4 LED Set Blue	LED-104G 4 LED Set Green	LED-104A 4 LED Set Amber
LED-106C 6 LED Set Clear	LED-106R 6 LED Set Red	LED-106B 6 LED Set Blue	LED-106G 6 LED Set Green	LED-106A 6 LED Set Amber

4 BULB LED set includes:

- 1 - connection box
- 1 - 6 foot power cord with
 - 1 - On/Off switch
 - 1 - button flash pattern selector with 4 selectable patterns
- 4 - LED heads
- 2 - 10 foot extension cables
- 2 - 15 foot extension cables
- Working voltage: 12V DC

6 BULB LED set includes:

- 1 - connection box
- 1 - 6 foot power cord with
 - 1 - On/Off switch
 - 1 - button flash pattern selector with 4 selectable patterns
- 6 - LED heads
- 3 - 10 foot extension cables
- 3 - 15 foot extension cables
- Working voltage: 12V DC

15 Watt Clear LED Replacements

LED-12A Amber bulb only
LED-12B Blue bulb only
LED-12C Clear bulb only
LED-12G Green bulb only
LED-12R Red bulb only

\$24⁹⁹

All prices subject to change. Any pictorial or typographical errors subject to correction when an order is placed.
Proof of occupation is required for purchase of any law enforcement items.

UAW WILL MATCH COMPETITORS PUBLISHED PRICES

ADVANCED GENERATION 3 HIDEAWAY STROBE LIGHTS

4 BULB STROBE SET

\$99⁹⁹

Clear only
Add \$19.00 for other colors

4 strobe heads



4 BULB strobe set includes:

- 1 - connection box
- 1 - 6 foot power cord with
- 1 - On/Off switch
- 1 - button flash pattern selector with 4 selectable patterns
- 4 - strobe heads
- 2 - 10 foot extension cables
- 2 - 15 foot extension cables
- Working voltage: 12V DC



120 WATT 6 BULB STROBE SET
\$119⁹⁹

Clear only
Add \$19.00 for other colors

2 Different set available in these colors

BS-06C 4 Bulb Set Clear	BS-06R 4 Bulb Set Red	BS-06B 4 Bulb Set Blue	BS-06A 4 Bulb Set Amber
BS-07C 6 Bulb Set Clear	BS-07R 6 Bulb Set Red	BS-07B 6 Bulb Set Blue	BS-07A 6 Bulb Set Amber

6 BULB strobe set includes:

- 1 - connection box
- 1 - 6 foot power cord with
- 1 - On/Off switch
- 1 - button flash pattern selector with 4 selectable patterns
- 6 - strobe heads
- 3 - 10 foot extension cables
- 3 - 15 foot extension cables
- Working voltage: 12V DC

4 or 6 extension cables

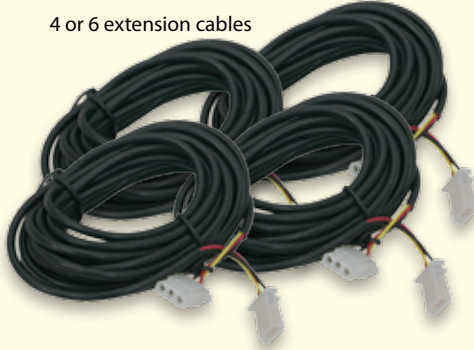

20 watt Clear Strobe Replacement Bulbs
\$14⁹⁵

BB-11C Clear bulb only BB-11R Red bulb only
BB-11B Blue bulb only BB-11G Green bulb only
BB-11A Amber bulb only

UAW HIDEAWAY GENERATION 3 LED LIGHTS

2 BULB LED set includes:

- 1 - connection box
- 1 - 6 foot power cord with
- 1 - On/Off switch
- 1 - button flash pattern selector with 4 selectable patterns
- 2 - LED heads
- 1 - 15 foot extension cables
- Working voltage: 12V DC

\$79⁹⁹

Clear only
Add \$5.00 for other colors



LED-102C 2 LED Set Clear	LED-102R 2 LED Set Red	LED-102B 2 LED Set Blue	LED-102G 2 LED Set Green	LED-102A 2 LED Set Amber
-----------------------------	---------------------------	----------------------------	-----------------------------	-----------------------------

15 Watt Clear LED Replacements 1" Diameter

LED-12A Amber bulb only
LED-12B Blue bulb only
LED-12C Clear bulb only
LED-12G Green bulb only
LED-12R Red bulb only

\$24⁹⁹

Tel: (877) 643-1100 ---- Toll Free
Fax: (877) 700-4477 ---- Toll Free

(818) 341-1500 (US & NON US calls)
(818) 341-0015 (US & NON US calls)

Phone Ordering Only
M-F 7:30am - 5:00pm PST
Sat 9am - 2pm PST

UAW LED WARNING LIGHTS PAIRS

- Compact LEDs with long life and efficient power usage
- Lights have colored lenses



**WL-01
AMBER**

**WL-03
BLUE**

**WL-02
RED**

\$39⁹⁹
per pair

3 1/4" H x 3 3/4" W x 2 1/2" D



**KIT INCLUDES: 2 LIGHTS,
12VDC POWER SUPPLY AND LIGHT CONTROLLER**

UAW STROBE WARNING LIGHT PAIRS

- Compact strobe lights for intense warning power
- Lights have color lenses • 3 1/4" H x 3 3/4" W x 2 1/2" D



**WL-04
AMBER**

**WL-05
BLUE**

**WL-06
RED**

\$39⁹⁹
per pair

**KIT INCLUDES: 2 LIGHTS,
12VDC POWER SUPPLY AND LIGHT CONTROLLER**

Replacement lenses available in these colors:

A R B G C \$4⁹⁹ each **FCLFN-01**

Please specify color when ordering

UAW STROBE WARNING LIGHTS

- Wide dispersion strobe lights for extreme warning power



\$49⁹⁹
per pair

3 "H x 5 3/4" W x 2 3/4" D

**WL-07
AMBER**

**WL-08
BLUE**

**WL-09
RED**

**INCLUDES:
POWER SUPPLY AND LIGHT CONTROLLER**
12V DC power supply can be used to control a pair of warning lights

UAW LED STEALTH WARNING LIGHTS

- Ultra bright compact LEDs • Clear lenses • Long life & efficient power usage • 3 1/4" H x 3 3/4" W x 2 1/2" D



**WL-01AC
AMBER**

**WL-01BC
BLUE**

**WL-01CC
CLEAR**

**WL-01RC
RED**

\$39⁹⁹
per pair

**WL-01GC
GREEN**

**KIT INCLUDES: 2 LIGHTS,
12VDC POWER SUPPLY AND LIGHT CONTROLLER**

*All prices subject to change. Any pictorial or typographical errors subject to correction when an order is placed.
Proof of occupation is required for purchase of any law enforcement items.*

UAW WILL MATCH COMPETITORS PUBLISHED PRICES

COLUMN PROTECTORS

- Highly visible bright yellow & black for maximum visibility
- Fade resistant in all weather conditions
- Easy to install



ROUNDED COLUMN PROTECTOR

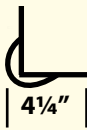

Made of 1" thick Rubber
Size: 32" tall

\$14⁹⁹
PRK-01 EACH

90° COLUMN PROTECTORS

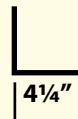

Made of 3/4" thick Rubber
Size: 32" tall

\$12⁹⁹
PRK-02 EACH

HARD HAT

- Adjustable suspension for a custom fit
- Ratchet Pin Lock
- Meets ANSI Standards
- Lightweight, durable, high density polyethylene material



\$7⁹⁹
▲ HH-01 EACH

BARRIER TAPE

A \$8⁹⁹ EACH



\$9⁹⁹ B EACH



C \$9⁹⁹ EACH



D \$9⁹⁹ EACH



E \$9⁹⁹ EACH



F \$9⁹⁹ EACH



G \$9⁹⁹ EACH



J \$10⁹⁹ EACH



H \$9⁹⁹ EACH



- Weather resistant vinyl
- Caution tapes are highly visible bright yellow background with black text
- 2" easy to read letters

Custom caution tape has a minimum order of 100 rolls at \$9⁹⁹ each. The delivery time is approximately 10 weeks. Call and ask for our art department about ordering. Law enforcement items require proof of occupation.

	SIZE	TEXT	ITEM #	Price
3" X 1,000 YARDS	A	CAUTION	TAP-01	\$8.99
	B	DANGER - YELLOW	TAP-02	\$9.99
	C	DO NOT ENTER	TAP-03	\$9.99
	D	FIRE LINE DO NOT CROSS	TAP-04	\$9.99
	E	CRIME SCENE DO NOT CROSS	TAP-05	\$9.99
	F	NO PARKING	TAP-06	\$9.99
	G	SHERIFF LINE DO NOT CROSS	TAP-07	\$9.99
	H	POLICE LINE DO NOT CROSS	TAP-08	\$9.99
	I	YOUR CUSTOM TEXT ON RED	TAPCUST-10	\$10.99
	J	YOUR CUSTOM TEXT ON YELLOW	TAPCUST-20	\$10.99

Tel: (877) 643-1100 ---- Toll Free
Fax: (877) 700-4477 ---- Toll Free

(818) 341-1500 (US & NON US calls)
(818) 341-0015 (US & NON US calls)

Phone Ordering Only
M-F 7:30am - 5:00pm PST
Sat 9am - 2pm PST

MODULAR RUBBER SPEED BUMP SYSTEM

- Made of compression molded composite, synthetic and natural rubber
- Highly resistant to weathering and extreme temperatures (-22°F to 140°F)
- Finishing is black or yellow rubber composite

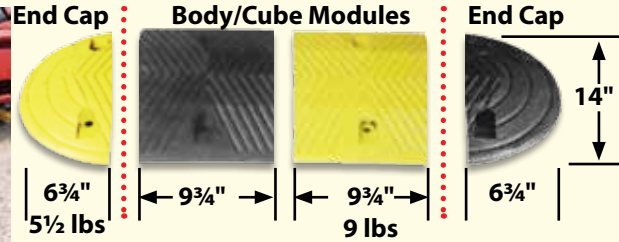

All modules are 2" Thick

DIFFERENT COMBINATION EXAMPLES

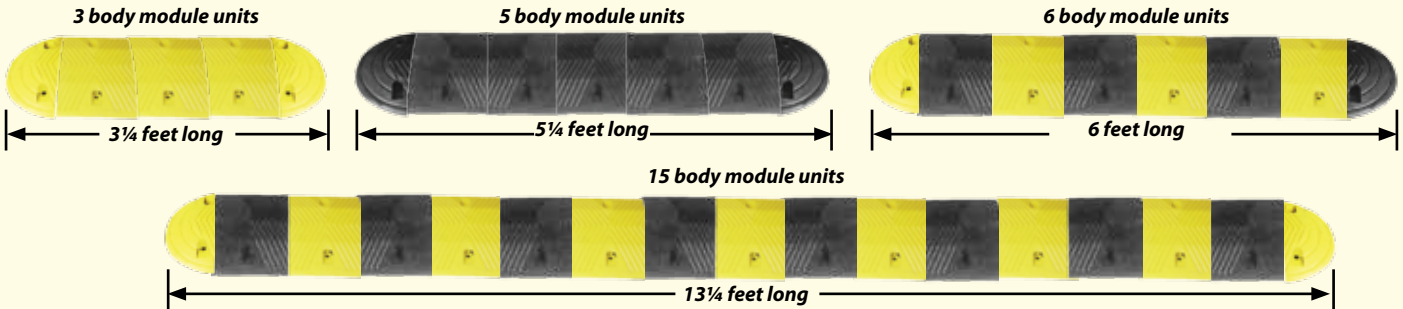

Individual units

MODULE	BLACK	YELLOW	PRICE
ENDS	SB-02	SB-03	\$7.99

MODULE	BLACK	YELLOW	PRICE
BODY/CUBES	SB-04	SB-05	\$9.99

COMBO UNITS: Just select the length you need and locate the number of modules you will require.

These lengths are when using stated number of center body modules and 2 end caps. Each length anchored by 2 1/2" dia bolts

Body Modules	2	3	4	5	6	7	8	9	10	11	12	13	14	15
Total Length	2 3/4'	3 1/2'	4 1/4'	5 1/4'	6'	6 3/4'	7 1/2'	8 1/2'	9 1/4'	10'	10 3/4'	11 3/4'	12 1/2'	13 1/4'

Additional lengths available on request. Call for quote.

PADLOCKS AND KEY HOLDER LOCKS

4-DIGIT KEY HOLDER BOX

- Hold several keys inside the storage lock
- Keyless convenience: set your own 4-digit combo
- Key storage door pivots open and remains attached for convenient operation
- Hardened steel shackle and zinc alloy body withstands hammering and sawing
- Size: 4 1/2"H x 2 1/2"W x 1/4"D



\$19⁹⁹ each
▲ LK-01

3-DIGIT ALPHABETIC LOCK BOX

- Holds several keys inside the storage lock
- Set your own 3-digit alphabetic combination
- Hardened steel shackle and zinc alloy body withstands hammering and sawing
- Size: 4 3/4"H x 2 1/4"W x 3/4"D

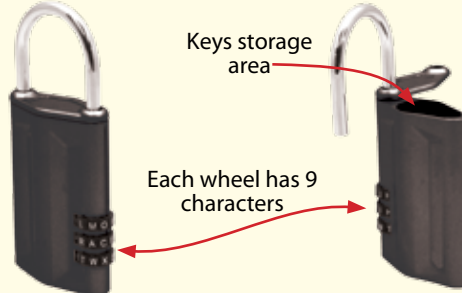

\$9⁹⁹ each
▲ LK-02

4-DIGIT PADLOCK

- Set your own 4-digit combo
- Hardened steel shackle and zinc alloy body withstands hammering and sawing
- Size: 3"H x 1 1/2"W x 1/2"D



\$4⁹⁹ each
▲ LK-03

All prices subject to change. Any pictorial or typographical errors subject to correction when an order is placed. Proof of occupation is required for purchase of any law enforcement items.

UAW WILL MATCH COMPETITORS PUBLISHED PRICES

HIGHLY VISIBLE SAFETY LIGHT

- Economical: powered by a lithium battery with storage life up to 10 years. Run time up to 10 hours
- Visible: up to ½ mile on road or water at night; daytime visibility to 100 feet; up to 10 miles from the air; use horizontal or vertical
- Durable & Reliable: virtually crushproof, no external switches or moving parts, no chemicals to decompose and unit is corrosion proof. Usable in the harshest of conditions
- Easy to Use: a convenient push button switch on the face to turn on and cycle through the 9 flash patterns
- Deployable in harsh environments: can be used in hot or freezing temperatures and underwater
- Uses 1 Lithium CR123A (included)
- Size: 4¼" diameter



Green version



- ◀ **FLR-01R RED**
- ◀ **FLR-01G GREEN**
- ◀ **FLR-01RG RED/GREEN**
- ◀ **FLR-01RB RED/BLUE**

Use to warn people of potential hazards!

Safe! Extremely bright! Lasts a long time!

SAFETY GLASSES



\$4⁹⁹

Each Pair

◀ **GL-11 CLEAR**

◀ **GL-12 YELLOW**

◀ **GL-13 BLACK**

2 SIDED TRAFFIC SIGN

- Hand held light weight reversible aluminum sign
- STOP on the front side and or SLOW on the opposite
- Both created with reflective materials
- Ideal for school functions, community events, fairs and concerts
- A necessity for security personnel, traffic directors and crossing guards



HANDHELD STOP SIGN

- Flashing red light on one side, stop sign on the other
- Ideal for school functions, community events, fairs and concerts
- A necessity for security personnel, traffic directors & crossing guards
- Uses 3 "C" batteries (not included)
- 16¼" long x 7¼" wide



WARNING TRIANGLE

Driving manuals suggest individuals carry a suitable warning triangle for use during breakdowns. For maximum visibility our fluorescent warning triangle includes a hanging Exclamation Point (!), increasing its reflective mass. Collapsing for easy storage, the triangle quickly unfolds for immediate use on its sturdy metal cross bow stand.



DISPOSABLE GLOVES

- Disposable • 5 MIL vinyl • Lightly powdered • Industrial grade
- Available in sizes: S-XL
- 5 MIL DISPOSABLE LATEX • Lightly Powdered • Industrial Grade
- Available in Size S-XL • Medical Grade



\$5⁹⁹ ▲ **GL-03**
Box of 50 pairs



\$5⁹⁹ ▲ **GL-07**
Box of 50 pairs

Safety cones are subject to oversize shipping cost

COLLAPSIBLE SAFETY CONES



\$16⁹⁹

CONE-07

Size: Height 21" Base: 12" x 12"

\$11⁹⁹



CONE-01

Size: Height 18" Base: 9½" x 9½"

- Highly visible
- Lightweight and easily carried
- Stores in a small space
- Made of waterproof cloth and ABS
- Collapsible height: 2"

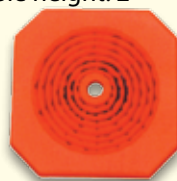

\$9⁹⁹



CONE-02

Size: Height 15" Base: 9½" x 9½"



SAFETY CONES BLINKER



- Flash rate: 150/min
- Requires 2 AAA batteries (not included)

BAR-09
\$3⁹⁹

REFLECTIVE ORANGE SAFETY CONES

- Highly visible bright red-orange for maximum visibility
- Reflective tape surfaces to increase visibility
- Fade resistant in all weather conditions
- Base designed for easy stacking without sticking
- Made of one continuous layer of PVC



\$8⁹⁹

Height 18"
Base: 11½" x 11½"
CONE-03



\$19⁹⁹

Height 28"
Base: 13¾" x 13¾"
CONE-04



\$29⁹⁹

Height 36"
Base: 14½" x 14½"
CONE-05

BARRICADE LED LIGHTS



- Highly visible bright orange 7" diameter
- Visible to 550 yards
- Flash rate 60 per minute
- Battery powered
- Battery life 500 hours
- Requires 2 D cell batteries (not included)

BAR-02: ORANGE
\$9⁹⁹

Battery Version

- Highly visible bright orange 7" dia.
- Lens pivots 90°
- Visible to 550 yards
- Flash rate 60 per minute
- Includes 6V battery (4R25)
- Battery life: 600 hours

BAR-03: ORANGE **\$19⁹⁹**

Solar Version

- Super high brightness LBD
- Flash frequency: 60/min
- Light color: Red & Yellow
- Visible to 500 yards
- Includes rechargeable 6V battery (4R25)

BAR-04: ORANGE **\$19⁹⁹**

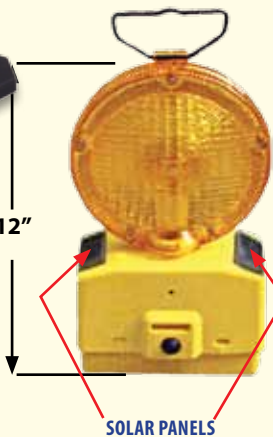

PORTABLE BOLLARDS AND CHAINS

- Highly visible bright red-orange
- Reflective tape surfaces increase visibility
- Fade resistant in all weather
- Keyhole slot on both sides for rope or chain (not included)
- Use for all road safety, maintenance and repair conditions
- Made of one continuous layer of P.E.



CH-10 10 feet" long chain **\$9⁹⁹**
CH-25 25 feet" long chain **\$19⁹⁹**
CH-100 100 feet" long chain **\$69⁹⁹**
CHLH-01 Set 2loops/2 hooks **\$1⁹⁹**

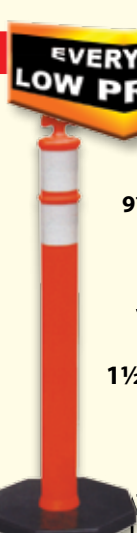

CONE-06
Base: 16" 4½"
round post
43" tall
\$16⁹⁹



Bollards are subject to oversize shipping cost

All prices subject to change. Any pictorial or typographical errors subject to correction when an order is placed.

Proof of occupation is required for purchase of any law enforcement items.

UAW WILL MATCH COMPETITORS PUBLISHED PRICES

HANDHELD SPEAKER

- Includes handheld speaker component with coiled cord.
- 7½" diameter
- 13½" length
- Uses 6 D-cell batteries (not included)



\$29⁹⁹

LB-33

LIGHT-WEIGHT WARNING WANDS

- Off, Flashing and Steady light switch
- Non-Slip Grip Handle
- Takes 2" Cell Batteries
- Built-in Belt and wrist Strap



21"

\$9⁹⁹

TB-01



15"

\$8⁹⁹

TB-02

DAR CLIPBOARD

- Essential for law enforcement & security personnel:
- Internal compartments: 1" depth standard bottom compartment and small ½" top compartment
- Wide top clip & additional small clip
- Built-in pen & pencil compartment
- Non-reflective hard aluminum
- Lightweight
- Dimensions: 9¼" W x 14" L



\$9⁹⁹

CB-07

WHISTLING LIGHT WARNING WAND



- Built-in warning whistle

\$9⁹⁹

TB-03 23"

HEAVY DUTY LIGHT WARNING WANDS

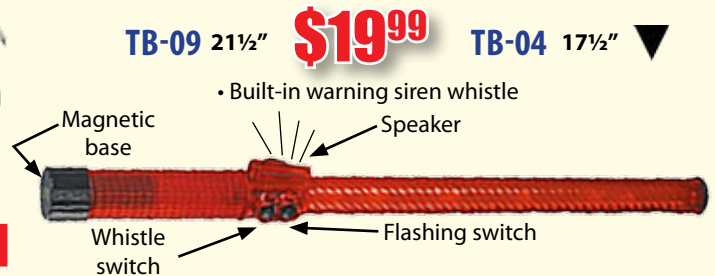

TB-09 21½"

\$19⁹⁹

TB-04 17½"

- Built-in warning siren whistle

\$16⁹⁹

TB-10

21½" with no magnet base

STROBE TRAFFIC BARRICADE LIGHT

- Highly visible bright yellow 8" tall
- Visible to 550 yards
- Flashing starts automatically at dark and stops at daybreak
- Flash rate 60 per minute
- Includes 6V battery (4R25)
- Battery life 600 hours

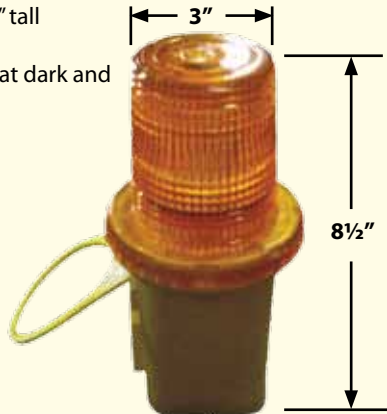

\$9⁹⁹
EACH

BAR-01

TRAFFIC DIRECTION SIGNS



- Bright LED flashing lights on a high reflective sheet
- Visible from more than 215 yards
- Battery: 3 AA
- Set of magnets on the back

\$19⁹⁹

DF-01

Size: " 32" wide X 17¾ High

SOLAR POWERED LED TRIPOD BEACON



\$9⁹⁹

BAR-10



- Bright LED flashing lights on a high reflective sheet
- Visible from more than 215 yards
- Battery: 3 AA
- Set of magnets on the back

\$19⁹⁹

DF-02

Size: " 32" wide X 17¾ High

CPR MASK

• Designed to provide protected rescue breathing for any patient (any age group) and may also be used with a resuscitator • Helps protect rescuers in an emergency situation



\$9⁹⁹ each **CPR-04** ▲

INSTANT ICE PACKS

• Provide immediate and effective cooling
• For pain relief apply cold immediately after an injury to reduce blood flow to the injury and combat swelling



\$1⁹⁹

9.8 oz - each

IC-04 ▲

99^c

5.6 oz - each

IC-03 ▲

KISS SAFE

• Avoids direct contact with person during artificial respiration



▲ **CPR-03**



\$1⁹⁹

each

FIRST AID KITS - SMALL - MEDIUM - LARGE

• All 3 kits meet CPR and ECC guidelines.

3"H x 5"W x 8"L



\$12⁹⁹

FA-05
SMALL KIT

SMALL KIT CONTAINS

- 20 Bandages Plastic 1"x3"
- 3 Bandages Plastic 2"x4.5"
- 1 Burn Jel 1/8 oz.
- 10 BZK Towelettes
- 1 Cold Pack
- 1 Elastic Bandage 3"
- 1 First Aid Guide
- 5 Gauze Pads Sterile 3"x3"
- 2 Gloves
- 1 Roll Gauze 2"x4yds
- 1 Scissor Kit
- 1 Splinter Forceps (tweezers)
- 2 Sting Relief Towelettes
- 1 Tape 1/2"x5 Uncovered
- 1 Triangular Bandage 40"x40"
- 5 Triple Antibiotic Ointment Packettes

3"H x 6.5"W x 9.5"L



\$24⁹⁹

FA-06
MEDIUM KIT

MEDIUM KIT CONTAINS

- 1 Bandages Plastic Assorted - (1"x3", 3/4"x3", 5/8"x2 1/4") 60/box
- 3 Bandages Plastic 2"x4.5"
- 1 Bio-Waste Bag 1 Gallon 11"x14"
- 2 Burn Gels 1/8 oz.
- 10 BZK Towelettes (tweezers)
- 1 Cold Pack
- 1 Compress 4"x4"
- 1 Elastic Bandage 3"
- 1 First Aid Guide
- 10 Gauze Pads Sterile 2"x2"
- 4 Gloves, Vinyl
- 1 Roll Gauze 2"x4 yds
- 1 Scissor Kit
- 1 Splinter Forceps
- 4 Sting Relief Towelettes
- 1 Tape 1/2"x5 yds Uncovered
- 1 Triangular Bandage 40"x40"
- 8 Triple Antibiotic Ointment Packettes

3"H x 9"W x 9.5"L



\$39⁹⁹

FA-07
LARGE KIT

LARGE KIT CONTAINS

- 1 Bandages Plastic Assorted - (1"x3", 3/4"x3", 5/8"x2 1/4") 60/box
- 5 Bandages Plastic 2"x4.5"
- 1 Bio-Waste Bag 1 Gallon 11"x14"
- 3 Burn Gels 1/8 oz.
- 20 BZK Towelettes
- 2 Cold Pack Unit
- 1 Compress 4"x4"
- 4 Cotton-tip Applicators 3" 2 pk
- 1 CPR Life Mask
- 1 Elastic Bandage 3"
- 1 Eye Pads Medium
- 1 Eye Wash 1 oz.
- 1 First Aid Guide
- 1 Gauze Pads Sterile 3"x3" (10/box)
- 4 Gloves, Vinyl
- 1 Roll Gauze 4"x4yds
- 1 Scissor lister
- bandage 4 1/2"
- 1 Splinter Forceps (tweezers)
- 4 Sting Relief Towelettes
- 1 Tape 1/2"x10 Uncovered
- 1 Triangular Bandage 40"x40"
- 10 Triple Antibiotic Ointment Packettes

All prices subject to change. Any pictorial or typographical errors subject to correction when an order is placed. Proof of occupation is required for purchase of any law enforcement items.

UAW WILL MATCH COMPETITORS PUBLISHED PRICES

LED RECHARGEABLE SPOTLIGHT

- High power LED rechargeable flashlight
- 5 watts • Equipped with a 6V 5Ah sealed lead acid battery
- Strobe and fixed light settings
- Auxiliary light in the handle
- Dual recharge, either AC-DC charger or 12V DC car plug adaptor
- Rainproof construction
- Carry belt • Hands free stand on top
- 5 hour use time
- Size: 3¾" Lens x 7¼" L x 8½" H
- Weight: 2¼ lbs



\$19⁹⁹ FL-50

UMBRELLA WITH LED HANDLE LIGHT



- Umbrella handle has an LED light up the shaft
- LED light to illuminate the ground
- Convenient control mode
- Easy to carry
- Uses 3 AAA batteries

▲ **BLACK: UL-01**

\$14⁹⁹

BIOMETRIC LOCK BOX

- This safe is convenient and state of the art • It opens at the touch of a finger..only yours!
- It will not recognize any others • Never again have to fumble for keys, lose them or worry about where to hide them • No complicated combinations to remember
- Protect your valuables, firearms, important documents, medicines, cash and jewelry



\$99⁹⁹ ▲
LKBOX-02

• Size: 11¾" x 15" x 11¾"

PROFESSIONAL UHF/VHF RADIO

Designed for heavy duty use. The radio comes pre-programmed and can be reprogrammed to your specification by purchasing the programming cable and downloading the free software from our web site. Includes 1500 mAh battery, desktop charger, antenna and belt clip.



Specifications:

- Switchable from UHF to VHF
- Frequency: 450-470 Mhz(UHF), 150-174Mhz(VHF)
- Compatible with most 2 prong Kenwood headsets & accessories
 - 16 channels
 - Built in tone signaling - CTCSS/DTCS
 - Range: 2 to 3 miles
 - RF Power: 5 watts

COMING SOON

◀ **\$129⁹⁹**
UA-600

SOLAR POWERED LED CONE TOPPER



Solar collector

- Solar powered
- High visibility flashing cone topper
- Sips over most safety cone tops
- Hook designed top for hanging
- Flashing in turn- Flashing meanwhile - steady

\$9⁹⁹ each

◀ **BAR-11**

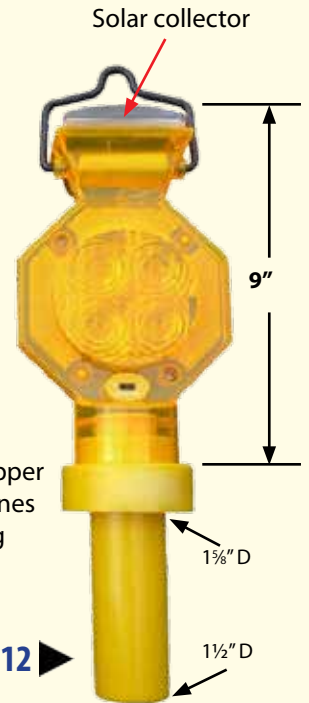

Solar collector

- Solar powered
- High visibility flashing cone topper
- Inserts in top of most safety cones
- Hook designed top for hanging
- Flashing in turn- Flashing meanwhile - steady

\$9⁹⁹

BAR-12 ▶

HANDLEBAR MOUNT FLASHLIGHT

- 3 watt LED bicycle flashlight • Uses 3 AAA batteries not included • Size: 1 1/4" x 5"



▲ **\$9⁹⁹** FL-56

6 LED FLASHLIGHT WITH MAGNET

- 6 LED flashlight with a magnetic pick up tool • Uses 1 AA battery included • Size: 1 1/8" x 8 1/2"

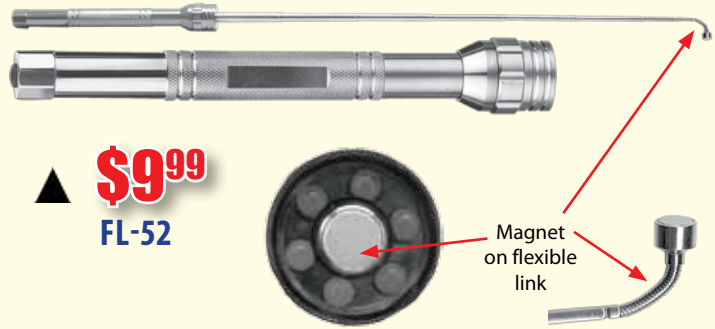

▲ **\$9⁹⁹**
FL-52

3 W LED FLASHLIGHT

- 3 Wt flashlight • 7 LEDs in flashlight
- 24 LEDs in handle
- Aluminium body
- Uses 3 AAA battery included
- Size: 1 1/2" x 9 3/4"
- Reading & warning light



▲ **\$9⁹⁹** FL-54

3 W RECHARGEABLE FLASHLIGHT WAND

- Lightweight and Durable Aluminum body
- Intense 3 Watt LED
- Rear button on-off
- Output: 100 lumens
- Continuous run time of 4 hours
- 3.6 voltage Rechargeable Battery (Included)
- 3 Multi-function modes (High beam, Low beam & Strobe)



▲ **\$24⁹⁹** FL-66

3 W LED FLASHLIGHT

- 3 Wt Cree aluminum body • Uses 2 AA batteries included • Size: 1" x 6"



\$9⁹⁹ FL-53 ▲

3 W HEAD MOUNT FLASHLIGHT



- 3 W Cree Ultra bright LED light
- Range of headlamp: 15 - 30 feet
- Power Supply: 3 AAA Batteries (Not included)
- LED service life: more than 100,000 hours
- Revolutionary focus technology
- Comes with adjustable head strap
- Adjustable inclination up and down
- Light zooms in and out

\$9⁹⁹ ▲ FL-55



All prices subject to change. Any pictorial or typographical errors subject to correction when an order is placed. Proof of occupation is required for purchase of any law enforcement items.

UAW WILL MATCH COMPETITORS PUBLISHED PRICES

ALL DAY COMFORT INSOLES



Sole Top



Sole Bottom
SOL-01

COMING SOON

- Elastic memory foam
- Shock absorption
- All day comfort
- Ideal for walking and running
- See web site for size information

\$2⁹⁹

SHOCK ABSORBENT INSOLES



Sole Top



Sole Bottom
SOL-02

COMING SOON

- Shock absorption
- All day comfort
- Built in arch support provides more confident foundation
- Improves your athletic/daily performance
- See web site for size information

\$4⁹⁹

GEL SHOE INSOLES



Sole Top



Sole Bottom
SOL-03

COMING SOON

- Unique designed super comfortable full length gel insole
- Provides cushion and shock absorption
- Cut to fit sizing
- Shock absorbing gel

\$4⁹⁹

VITAL-ION INSOLES



- Can help to remove harmful positive ions from your body and gain the beneficial effects of negative ions
- Size Small: 11¼" and Medium: 12½"
- Can be cut to fit any shoe size

VI-05B BLACK

\$9⁹⁹ Each pair



LED FLASHLIGHT

- Rechargeable • 5 watt



\$34⁹⁹

FL-60



COMING SOON

- 3 D-cell version • 5 watt



\$19⁹⁹

FL-61



COMING SOON

- 3 C-cell version • 3 watt



\$14⁹⁹

FL-62



20 WATT LED SPOT LIGHT

- High power, long-life LED bulb
- 12 volt DC accessory outlet
- Replaceable sealed lead-acid battery • AC/DC recharge adapter and power cord
- Fused DC/DC recharge adapter
- LED charging indicator
- Removable carry strap • Protective rubber safety guard (bezel) around lens
- Hands-free adjustable workstand with position locks
- 5 hour duration
- Size: 14"L x 11"H x 9"D
- Weight: 9lbs



Adjustable work stand

FL-51

\$99⁹⁹

VITAL-ION SOCKS



- Uses nano-sized particles of gold encased in a titanium shell
- Purification of the blood
- Regeneration and recovery of cells
- Enhancing blood circulation
- Remove the acid from muscle and release the pain

See web site for washing instructions

\$9⁹⁹

Each pair

SO-03B BLACK

SO-03N NAVY

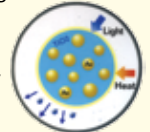

SUDECON DECONTAMINATION TOWELETTE

Instantly lifts pepper spray from the skin. The burning subsides in approximately 15 min or less.

DT-01
99¢

**QUICK DRAW GUN MAGNET**

Keep your hand gun handy! Now you can easily mount your gun under a desk, shelf, on a door or a wall. Installs with only 2 screws (not included). Holds up to 10 lbs

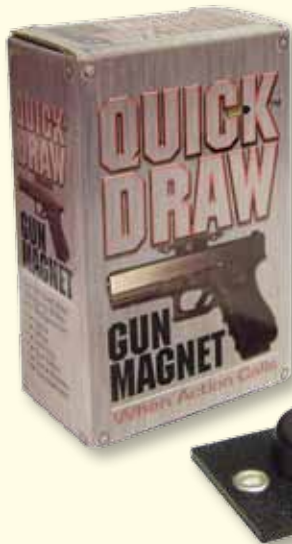

GM-01
\$19⁹⁹

**ANKLE HOLSTER**

Genuine high-grade leather with heavy duty elastic and Velcro band. Right or left hand use. With separate calf strap for added support.



AH-01
\$19⁹⁹

UNIVERSAL GUN CLEANING KIT

Complete in an attractive, strong aluminum case. Contains all brass rods, mops and adaptors to clean a majority of all rifles, pistols and shotguns from 17 cal to 12 gauge.

GC-01
\$19⁹⁹

**BOOT BRUSH**

Made to last and withstand outdoor use. There are three extra-stiff bristled brushes mounted on a durable stand. Heavy-duty carbon steel base includes mounting screws and a rubber pad for floor protection. Weight: 42 oz size: 8½" x 11" x 4½"

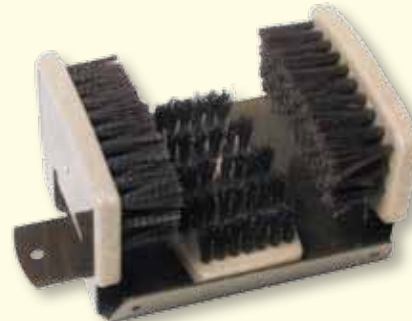

BB-01
\$19⁹⁹

ZAP CANE™ STUN GUN & FLASHLIGHT

SGC-01
\$69⁹⁹

- Adjustable height 32" to 36"
- Weight capacity 250 lbs
- Ultra-bright LED flashlight
- Built-in rechargeable NiMH Battery
- Includes wall charger and carry case
- 1 Million volts

All prices subject to change. Any pictorial or typographical errors subject to correction when an order is placed. Proof of occupation is required for purchase of any law enforcement items.

UAW WILL MATCH COMPETITORS PUBLISHED PRICES

NEW ITEMS
NEW ITEMS
NEW ITEMS
NEW ITEMS
NEW ITEMS
NEW ITEMS
NEW ITEMS
NEW ITEMS

NYLON BDU TACTICAL BELTS

- Nylon belting • High strength plastic buckle



1½" Wide
\$8⁹⁹

Available sizes:
Small to 3XL
For sizes 2XL-3XL
add \$3.00

1¾" Wide
\$9⁹⁹

Belt Color	1½" Wide	1¾" Wide
Black	NB-02B	NB-01B
Green	NB-02G	NB-01G
Tan	NB-02T	NB-01T

GUARDSCAN KEY CHAIN BUTTON TAG

- Attaches to your key chain for easy use
- Ideal for personal identification and patrolman tracking
- Compatible with GS3000 Patrol Tour System
- Waterproof
- 5-10 years life
- Operating temperature: -15°C-50°C(5°F-122°F)
- Non-operating temperature: -40°C-80°C(-40°F-176°F)



GS-3007

\$3⁹⁹
MSRP: \$4.99

See more tags
on page 83.

REFLECTIVE ARMBANDS

• Reflective slap wrap armbands • Reflective PVC tape with metal spring inside

• Will fit arm, forearm or even wrist areas

99¢

◀ **RT-01**

COMING SOON

Flashing lights

On/Off button

• 100% polyester reflective material

• Elastic and Velcro adjustments

• Flashing LED lights

\$5⁹⁹ **RT-02**

REFLECTIVE SAFETY VESTS

- 100% polyester 300 Oxford PU coated material
- 2" wide high reflective tape
- Zipper front
- Warm lining



COMING SOON

SV-100
\$19⁹⁹

Sizes:
Small - 3XL

REFLECTIVE SAFETY VESTS

SV-101 PLAIN NO ID

\$9⁹⁹

Black text only

COMING SOON

- SV-101SB SECURITY
- SV-101PB POLICE
- SV-101SHB SHERIFF
- SV-101ESB EVENT STAFF

\$11⁹⁹



Sizes: Small - 3XL

3M REFLECTIVE SAFETY VESTS

2 Mic holder

Clear ID holder pocket

- 100% polyester
- 3M Scotchlite reflective tape
- 2" wide reflective tape

2 pockets

Available sizes:
Small - 5XL

\$9⁹⁹

SV-102

COMING SOON

How-to-Measure for Men and Women

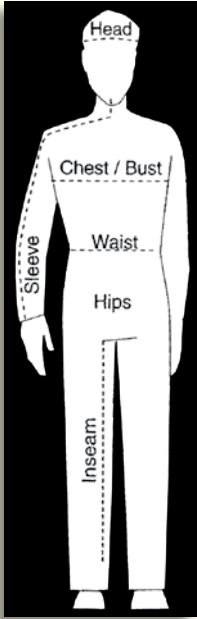

FOR HELMETS, CAPS OR HAT SIZE Use a cloth measuring tape to determine your correct cap or hat size. Measure completely around the head, starting 1" above the eyebrows in the front and going around the largest point at the back of the head. (See chart below)

FOR CHEST/BUST SIZE — Measure just below the arms, completely around the back and across the broadest part of the chest area. Hold tape firm and level.

NECK — Measure a shirt that fits you well. Lay the collar flat and measure from the center of the collar button to the far end of the button hole. The number of inches equals your size.

SLEEVE — Measure from the center of the collar (in the back), across the shoulder and down the sleeve. Number of inches equals sleeve length.

FOR WOMEN'S HIPS — Stand with heels together and measure around the fullest part of hips.

INSEAM — Take a pair of uniform pants (not jeans) that fits you well. Measure (to nearest inch) from the crotch seam to the bottom of pants.

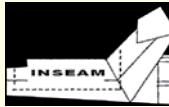

BELTS — Order your belt 2" larger than your waist size. If between "even" sizes, order the next larger size.

GLOVES — Measure around your dominant hand at fullest part (exclude thumb). Number of inches equals glove size.



Youth T-Shirt Sizes

Size	Body Sizes	
	Age	Chest
Small	2-4 years	22-24 in (55.9 - 61 cm)
Medium	6-8 years	24-27 in (61 - 68.6 cm)
Large	10-12 years	27-30 in (68.6 - 76.2 cm)
1XL	14 -16 years	30-33 in (76.2 - 83.8 cm)

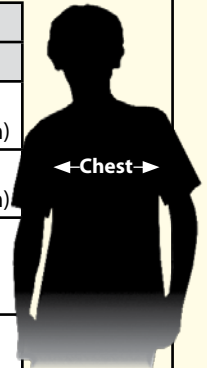

MAKE A COPY OF THIS RULER TO MEASURE AND CHECK YOUR SIZES

SHOE/BOOT SIZE CONVERSION CHART

Men's Size	6	7	7½	8	8½	9	9½	10	10½	11	11½	12	12½	13	14
Women's Size		8½	9	9½	10	10½	11	11½	12	12½	13	13½	14	14½	15½

SHIRT NECK SIZE CHART

Small	Medium	Large	XL	2XL	3XL	4XL	5XL
14-14½	15-15½	16-16½	17-17½	18-18½	19-19½	20-20½	21-21½

HAT CONVERSION CHART

			S	M	L		XL	2XL				
US	6 ⁵ / ₈	6¾	6 ⁷ / ₈	7	7 ¹ / ₈	7¼	7 ³ / ₈	7½	7 ⁵ / ₈	7¾	7 ⁷ / ₈	8
CM	53	54	55	56	57	58	59	60	61	62	63	64
Inches	20¾	21¼	21 ⁵ / ₈	22	22½	22¾	23¼	23 ⁵ / ₈	24	24½	24¾	25 ¹ / ₈

JACKET CHEST SIZE CHART

Small	Medium	Large	XL	2XL	3XL	4XL	5XL
32-34	36-38	40-42	44-46	48-50	52-54	56-58	60

GLOVE SIZE CHART

Small	Medium	Large	XL	2XL	3XL
8	9	10	11	12	13

All prices subject to change. Any pictorial or typographical errors subject to correction when an order is placed.

Proof of occupation is required for purchase of any law enforcement items.

UAW WILL MATCH COMPETITORS PUBLISHED PRICES

UNIFORMS & ACCESSORIES WAREHOUSE

20701 Nordhoff Street, Chatsworth, CA 91311

Store Hours: 9:00am - 5:00pm (M - F) PST

9:00am - 2:00pm (Sat) PST

Tel: (877) 643-1100 Toll Free (US Only)

(818) 341-1500 (US & Non US)

Fax: (877) 700-4477 Toll Free (US Only)

(818) 341-0015 (US & Non US)

PRESORTED STANDARD

U.S. POSTAGE PAID

Glendale, CA

Permit No. 384

Easy Ways To Order

Call

Call our toll-free number:

877-643-1100

818-341-1500

Monday - Friday: 7:00 am - 5:00 pm PST

Saturday: 9:00 am - 2:00 pm PST

Drop In

Visit our retail store at:

20701 Nordhoff Street
Chatsworth, CA 91311

Monday - Friday: 9:00 am - 5:00 pm PST

Saturday: 9:00 am - 2:00 pm PST

Fax

Fax your order to:

877-700-4477 (US customers only)

818-341-0015 (US & Non US customers)

24 hours a day

NEW RETAIL LOCATION

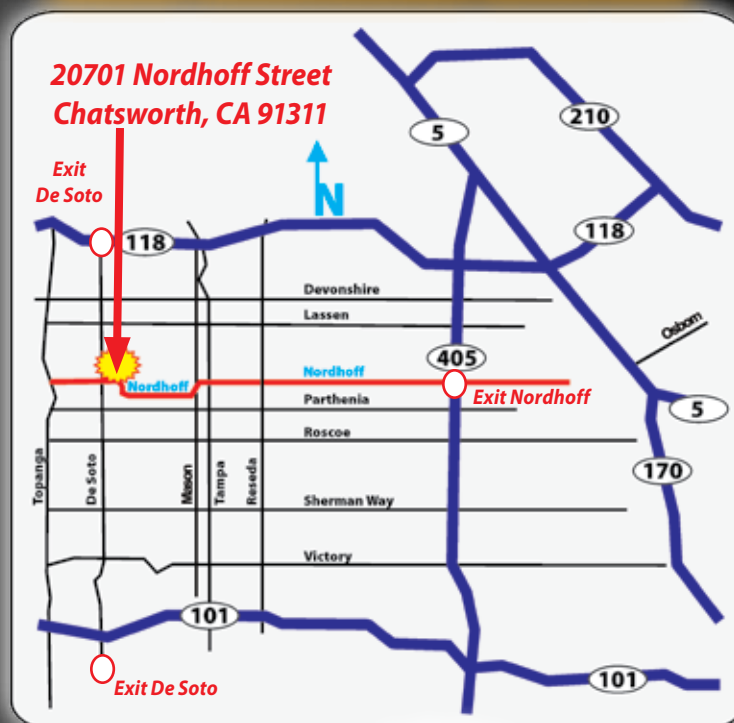

Browse & buy from our secure web site:

uniforms4all.com